



REV GROUP

AFT Chassis
CAT. E-ONE-AFT-2401
January 2024

AFT CHASSIS OPERATIONS & SERVICE MANUAL



E-ONE, Inc.

Operation and Service Manual

All information and specifications contained in this manual are based on the latest information available at the time of printing and are subject to change. Illustrations in this manual are intended for reference use only.

E-ONE reserves the right to discontinue or change specifications or design at any time without prior notice and without incurring any obligation whatsoever.

Brand names may be used in this manual to clarify illustrations or descriptions.

E-ONE
1601 SW 37th Avenue
Ocala, FL 34474

COPYRIGHT 2024

Using this document

This document is expected to be used as an electronic pdf document as well as a printed document. Various software can be used to view the document, including [Adobe® Acrobat Reader DC](#). Other pdf viewers are available.

As an electronic document, various links are included to help you navigate the document and find the applicable information. Links may be cross references within the document or an external link to an Internet page. Links shown in blue, underlined text, such as the link to the Acrobat Reader DC software in the preceding paragraph. For an Internet link to work, the device must be connected to the Internet in some way. Data charges may apply.

NOTE: Most pdf viewer software provides a command for previous view. In Acrobat Reader, for instance, the previous view on the View/Page Navigation menu. Keyboard shortcuts are also available, such as Alt+Left Arrow and Alt+Right Arrow for Previous View and Next View, respectively.

GENERAL INFORMATION 1.1

- Vehicle Identification Number 1.1
- Chassis Warranty And Registration..... 1.1
- Emissions Warranty 1.1
- Maintenance Records 1.1
- Use OEM parts for repair..... 1.2
- Vehicle Data Recorder (VDR) Systems 1.2
 - Gross Vehicle Weight Rating (GVWR) 1.3
 - Gross Combination Weight Rating (GCWR)..... 1.3
 - Gross Axle Weight Rating (GAWR) 1.3
- Cab Seating Layout Identification..... 1.3

GENERAL SAFETY 2.1

- Introduction..... 2.1
 - Operator Manuals..... 2.1
 - Major Component Manuals..... 2.1
 - Industry Standards and Guidelines 2.1
 - Apparatus Modifications 2.2
- Extrication and Air Bags..... 2.2
- To the Apparatus Driver/Operator 2.2
- To the Apparatus Mechanic..... 2.3
- To the Safety Officer..... 2.3
- To the Training Officer..... 2.4
- To the Fire Chief..... 2.4
 - Parades and Public Events 2.4
 - Not Designed for Children..... 2.4
 - Vehicle Data Recorder..... 2.5
- Safety Alerts..... 2.5
 - Safety Alert Symbol 2.5
 - Signal Words..... 2.5
- Follow a Safety Program..... 2.6
 - Always Be Alert..... 2.6
 - Be Careful..... 2.6
 - Know the Rules 2.6
 - Commercial Driver’s License Course..... 2.7
 - Practice Safe Practices 2.7
 - Safety Signs..... 2.7
 - Operate Only What You Know..... 2.7
 - Operate Only Well Inspected Apparatus..... 2.7
- General Hazard Identification..... 2.8
 - Jewelry and Loose Personal Items..... 2.8
 - Pinch and Crush Hazards..... 2.8
 - Rotating Parts Hazards..... 2.8

TABLE OF CONTENTS

Exhaust Fumes.....	2.9
Chemical Exposure.....	2.10
Fire	2.10
Electrical Shock	2.10
Noise	2.11
Undercarriage.....	2.12
Custom Chassis Safety.....	2.12
Understand Your Operating Environment	2.12
Know Your Response Area.....	2.12
Know Your Climate.....	2.13
Know the Rules of the Road	2.13
Traffic Signal Capturing	2.13
Securing Equipment.....	2.13
Secure Interior Equipment.....	2.13
Secure Exterior Equipment.....	2.14
Restrain Hose.....	2.14
Working on Top of your Apparatus.....	2.15
Avoid Climbing and Walking on Top.....	2.15
Clean From the Ground	2.15
Use Three Points of Contact.....	2.15
Clean and Repair	2.16
Slip Resistant Surfaces	2.16
Designated Stepping, Standing and Walking Surfaces	2.16
Folding Steps or Ladders.....	2.17
Open Compartment Doors	2.17
Working on Top of the Apparatus.....	2.17
Climbing Prohibitions.....	2.18
Working Around the Apparatus.....	2.18
Ride Safely	2.18
Cab Capacity.....	2.18
Seat Belts.....	2.18
Seat Back Position	2.19
Shoulder Belt Positioning	2.19
Safest Posture.....	2.19
Seatbelt Sliding Komfort Latch®.....	2.20
Transporting Children	2.20
Seats Without Seat Belts.....	2.20
Swivel Seats.....	2.20
Air Bags	2.21
Helmets.....	2.21
SCBA Storage	2.22
SCBA Pack Buckles and Receivers.....	2.22
Drive Safely.....	2.23
Controls Adjustment	2.23

TABLE OF CONTENTS

Driver Seat Adjustment	2.23
Mirror Adjustment	2.23
Visibility Check.....	2.23
Seat Belt Monitoring.....	2.24
Know Your Tire Limitations.....	2.24
FEMA Fire Tanker Guidelines	2.24
Liquid Loads and High Center of Gravity.....	2.24
Driving on Rough Roads	2.25
Driving Off-Road	2.25
No-Spin Axle Differential.....	2.26
Tire Chains.....	2.26
Water Fording.....	2.26
Heater Shut-Off Valve.....	2.27
Stop Safely.....	2.27
Brake System Pressure	2.27
Anti-Lock Brake Systems.....	2.27
Maintaining Control	2.27
New Brake Lining Performance.....	2.27
Quick Build-Up Air Brake Pressure System	2.27
Auxiliary Braking Systems.....	2.28
Descending Steep Grades.....	2.28
Electronic Stability Control.....	2.28
Parking Brakes and Wheel Chocks	2.29
Auxiliary Front Wheel Lock.....	2.29
Backing Your Apparatus	2.29
Parking Safely.....	2.30
Parking On a Grade	2.30
Park Away From Fire.....	2.30
Park Away From Fuel Vapors	2.31
Leaving Apparatus Unattended.....	2.31
Park Away From Power Lines	2.31
Idle Mitigation.....	2.32
Winch and Rope Anchors	2.32
Fuel Safely.....	2.33
Before Placing your Apparatus In-Service.....	2.33
Install Electronic Equipment Properly.....	2.33
Install Front Bumper Mounted Equipment Properly.....	2.34
Install Cab Interior Equipment Properly	2.34
Install Air Pressure Operated Equipment Properly	2.34
Consider Dissimilar Metals When Mounting Equipment.....	2.35
Load your Apparatus Properly	2.35
Establish Correct Tire Pressure Values.....	2.35
Leaf Spring Suspensions With U-Bolts.....	2.35
Safety Equipment.....	2.36

TABLE OF CONTENTS

Demonstration and Training	2.36
Pumper Safety	2.36
Storing, Deploying and Retrieving Hose Safely.....	2.36
Snags and Snarls.....	2.36
Slips and Falls.....	2.37
Driving while Deploying	2.37
Driving while Retrieving.....	2.37
Hose Bed Covers.....	2.38
Using Hose Safely	2.38
Hose on the Fire Scene	2.38
Testing Hose	2.38
Discharge Water Safely.....	2.38
Water Stream.....	2.38
Power Lines and Fire Suppression	2.38
Boiling Discharge Water	2.39
Matching Equipment to Pump Pressure.....	2.39
Pump Operation	2.39
Emergency Pump Procedures With Failed Engine Control.....	2.39
Pressure Fluctuations	2.39
Intake and Discharge Caps	2.40
Pump and Roll	2.40
High Pressure Two-Stage Pump	2.41
Ultra-High Pressure Water Stream	2.41
Ultra-High Pressure Piercing Equipment.....	2.41
Foam Concentrate Types.....	2.42
Water Monitor	2.42
Ground Water Monitor	2.42
Aerial Safety.....	2.42
Emergency Stop Feature.....	2.43
Emergency Power Unit	2.43
Over-Ride Controls.....	2.43
Interlocks.....	2.43
Prepare for Safe Aerial Operation.....	2.44
Select a Site	2.44
Set-Up	2.45
Setting Up Within Safe Limits	2.45
Short-Jacking	2.46
Operating Your Aerial Safely	2.47
Primary Control Operator	2.47
Secondary Control Operator.....	2.48
Use of a Spotter	2.48
Avoid Overhead Power Lines	2.48
Extra Precautions Around Power Lines.....	2.49
If Your Device Becomes Electrified	2.49

TABLE OF CONTENTS

Rungs Aligned.....	2.49
Fall Protection.....	2.49
Climbing the Aerial Ladder.....	2.50
Water Towers.....	2.51
Boom Style Platform.....	2.51
Wire Rope Hazard	2.51
Operating With Personnel on the Aerial Ladder	2.52
Ladder Base Pinch and Crush.....	2.53
Operating with Personnel Near the Aerial	2.53
Operating Within Safe Limits.....	2.53
Load Chart Limits and People on the Ladder	2.54
Approaching Structures	2.54
Operating Above Structures	2.55
Icing Conditions	2.55
Windy Conditions	2.55
Flying Flags	2.56
Lightning Threat.....	2.56
Rope Rescue	2.56
Positionable Waterway Monitor	2.57
Aerial Ladder Pipe Operation	2.58
Tractor Drawn Aerial Operations.....	2.58
Tiller Cab Safety.....	2.58
Tiller Steering Lock.....	2.58
Tiller Steering.....	2.58
Tractor Operator Training.....	2.58
Tiller Operator Training.....	2.59
Fifth Wheel Lock.....	2.59
Perform Maintenance Safely.....	2.59
Maintenance Records.....	2.59
Use OEM Parts for Repair.....	2.59
Running the Engine	2.60
Preparing for Maintenance.....	2.60
Compressed Air for Cleaning - DO NOT USE.....	2.61
Chemicals and Cleaners.....	2.61
Decontamination Chemicals	2.61
Tilting the Cab.....	2.62
Lock-Out Tag-Out.....	2.62
Access Features Not Provided	2.63
Confined Space	2.63
Welding.....	2.63
Interlocks.....	2.64
Batteries	2.64
Battery Charging	2.64
High Pressure Hydraulic Fluid.....	2.65

TABLE OF CONTENTS

Aerial Device Equipment Mounting.....	2.65
Aerial Device Inspection.....	2.65
Radiator Cap.....	2.66
Seat Belt Inspection and Replacement.....	2.66
Side Roll or Frontal Crash Occupant Protection.....	2.67
Suspension Seat Tethers.....	2.67
Tire Inflation Pressure.....	2.67
Tire Wear Inspection.....	2.68
Tire Replacement.....	2.68
Manual Parking Brake Release (Caging the Brakes).....	2.69
Line-Voltage Components and Wiring.....	2.69
Shoreline Electrical Connection.....	2.69
Wire Rope Inspection or Maintenance.....	2.69
Air Conditioning Refrigerant.....	2.69
Towing Your Apparatus.....	2.70
No-Spin or Locking Differentials.....	2.70

CONTROLS & COMPONENTS DESCRIPTIONS..... 3.1

Overview.....	3.1
Cab Tilt Controls.....	3.1
Power Windows (If Equipped).....	3.2
Door Locks.....	3.2
Cab Dome Lamps.....	3.3
Seat Controls.....	3.3
Door Ajar System (If Equipped).....	3.4
Steering System And Column Controls.....	3.4
Optional steering wheel controls.....	3.6
Graphical Instrument Cluster.....	3.8
Traditional Instrument Cluster.....	3.13
Engine Starting/Stopping.....	3.15
Driver's Console.....	3.16
Main Console.....	3.17
Auxiliary Braking.....	3.18
Transmission Output Retarder.....	3.18
Electric Driveline (Telma) Retarder.....	3.19
Driver Assist Systems.....	3.19
Engine Cooling Fan Clutch Control (If Equipped).....	3.20
Class 1 Total System Manger (If Equipped).....	3.21
Multiplex Control Vista Display (If Equipped).....	3.24
Diagnostics Menu.....	3.30
Pump Mode Info - (If Equipped).....	3.31
HVAC Diagnostics For Dual Overhead System.....	3.31
V-MUX® Diagnostics Menu.....	3.33

TABLE OF CONTENTS

HVAC Menu For Dual Overhead System	3.35
HVAC Menu For Single Overhead HVAC System.....	3.37
Heat A/C-Climate Control Menu-Tunnel Mounted Auxiliary HVAC And Upper Heater/Defroster Unit...	3.38
Vista Touch Screen (If Equipped).....	3.39
HVAC Menu For Dual Overhead HVAC System	3.40
HVAC Menu For Single Overhead HVAC System.....	3.40
Climate Control.....	3.41
Dual Overhead HVAC System.....	3.42
Single Overhead HVAC System	3.43
Single Overhead Heating/Defroster System	3.44
Tunnel Mounted HVAC System	3.44
OPERATIONS.....	4.1
Overview.....	4.1
Pre-Operation	4.1
Before Getting in the Cab.....	4.1
Before Driving Away.....	4.1
Electric Door Lock Operation (If Equipped).....	4.2
To Start/Stop The Engine	4.4
Transmission.....	4.4
Auxiliary Braking.....	4.5
VGT (Variable Geometry Turbocharger, Exhaust Brake, OR Compression Brake)	4.6
Tandem Inter Axle Differential Lock.....	4.6
Differential Lock.....	4.7
Park Brake.....	4.7
Front Axle Wheel Lock.....	4.7
Cab tilt procedure	4.8
SERVICE PROCEDURES	5.1
Overview.....	5.1
Cab Finish Care Recommendations	5.1
The first 30 days.....	5.1
The first 90 days.....	5.1
Advanced Protection System (APS) (If Equipped).....	5.2
Occupancy Rollover Protection (Rolltek® SRS) (If Equipped)	5.11
Cab Tilt System	5.12
Servicing Advance Protection System Components	5.13
APS Handling Do's And Don't.....	5.14
Storage of APS Components	5.14
Shipping	5.15
Towing (If Equipped)	5.15
On Board Diagnostic (OBD) (If Equipped)	5.15
(Optional) V-Mux Programming and Troubleshooting Connection.....	5.16

TABLE OF CONTENTS

Owners/Operators:.....	5.17
Electrical system.....	5.18
E-One Mobile Gateway (If Equipped).....	5.20
Climate Control.....	5.21
HVAC Venturi Drain Maintenance (If Equipped)	5.24
HVAC Gravity Drain Maintenance (If Equipped).....	5.26
Engine.....	5.27
Ember Separator.....	5.32
Cooling System.....	5.34
Transmission.....	5.46
Exhaust/Aftertreatment System.....	5.50
DEF Tank/Heater	5.57
Steering System.....	5.59
Brake SYSTEM.....	5.60
Maintenance For Telma® Retarders.....	5.62
Axles/Wheels And Tires.....	5.63
Maintenance Schedules And Checklist	5.66
Maintenance Schedule.....	5.66
APPENDIX.....	6.1
Graphical Symbol Definitions.....	6.1

LIST OF FIGURES

Figure 1-1. Cab Seating Layout.....	1.3
Figure 4-1. Level indication of 6 degrees	2.45
Figure 4-2. Short Set Rotation Interlock Stop Points	2.47
Figure 3-1. Cab Tilt Pendant Control.....	3.1
Figure 3-2. Lowering Cab - Safety Support Mechanism Release Cable	3.1
Figure 3-3. Power Windows (If Equipped)	3.2
Figure 3-4. Manual Door Lock.....	3.2
Figure 3-5. Power Door Locks.....	3.3
Figure 3-6. Key Fob (If Equipped)	3.3
Figure 3-7. Tilt & Telescoping Steering Column	3.4
Figure 3-8. Steering Wheel and Center Controls.....	3.8
Figure 3-9. Driving Screen.....	3.8
Figure 3-10. Joystick/Rotary Control	3.9
Figure 3-11. Menu Selection and Message Center	3.10
Figure 3-12. Settings Menu	3.10
Figure 3-13. Diagnostics Menu	3.11
Figure 3-14. Diesel Particulate Filter (DPF) Menu	3.11
Figure 3-15. Camera Screen.....	3.12
Figure 3-16. Auxiliary Air Pressure.....	3.12
Figure 3-17. Brake Application Pressure.....	3.12
Figure 3-18. Amp Meter.....	3.13
Figure 3-19. Hour Meters.....	3.13
Figure 3-20. Traditional Instrument Cluster.....	3.13
Figure 3-21. Starting/Stopping Panel	3.15
Figure 3-22. Driver's Console	3.16
Figure 3-23. System Manager (If Equipped)	3.22
Figure 3-24. Vista IV Standard Controls	3.25
Figure 3-25. Vista IV Interface Features.....	3.25
Figure 3-26. Vista IV Display Control Buttons with Heat A/C	3.26
Figure 3-27. Vista IV Display Control Buttons without Heat A/C	3.27
Figure 3-28. Multi-Function Buttons	3.28
Figure 3-29. Secondary Menu	3.29
Figure 3-30. Warning Light Menu	3.29
Figure 3-31. System Info Menu	3.29
Figure 3-32. Diagnostics Menu	3.30
Figure 3-33. Pump Mode Info - (If Equipped)	3.31
Figure 3-34. HVAC Diagnostics for Dual Overhead System	3.31
Figure 3-35. HVAC Diagnostics for Single Overhead System.....	3.32
Figure 3-36. Rocker Switch.....	3.32
Figure 3-37. Vista Screen.....	3.32
Figure 3-38. High Idle Diagnostics.....	3.33

LIST OF FIGURES

Figure 3-39. Occupant Restraint Status	3.33
Figure 3-40. V-MUX Diagnostics Menu (Node Info)	3.34
Figure 3-41. V-MUX Diagnostics Menu (Node Voltages)	3.34
Figure 3-42. V-MUX Diagnostics Menu (Open/Short Circuits)	3.34
Figure 3-43. V-MUX Diagnostics Menu (Node List)	3.35
Figure 3-44. HVAC Menu for Dual Overhead System	3.35
Figure 3-45. HVAC Menu for Single Overhead System.....	3.37
Figure 3-46. Vista Touch Screen (If Equipped Home Menu)	3.39
Figure 3-47. HVAC Menu for Dual Overhead HVAC System.....	3.40
Figure 3-48. HVAC Menu for Single Overhead HVAC System	3.40
Figure 3-49. Dual Overhead HVAC System.....	3.42
Figure 3-50. Single Overhead HVAC System	3.43
Figure 3-51. Headliner Center Section Shown.....	3.43
Figure 3-52. Single Overhead Heating/Defroster System.....	3.44
Figure 3-53. Tunnel Mounted HVAC System	3.44
Figure 3-54. Heater Shut-off Valve Under Cab	3.45
Figure 4-1. Park Brake	4.7
Figure 4-2. Raising the Cab - Lock Mechanism	4.9
Figure 4-3. Manual Tilt Pump Devices (If Equipped).....	4.10
Figure 5-1. Officer Side Interior/Exterior Photos.....	5.3
Figure 5-2. APS Components.....	5.4
Figure 5-3. APS Components Located at Base of Steering Column	5.4
Figure 5-4. Air Bag Module Locations.....	5.5
Figure 5-5. Officer Side - Air Bag Module Locations	5.5
Figure 5-6. Drivers Side - Air Bag Module Locations	5.5
Figure 5-7. Steering Wheel Air Bag Deployment	5.6
Figure 5-8. Steering Wheel Air Bag Deployment Zone.....	5.7
Figure 5-9. Driver Side Knee Air Bag Deployment Zone	5.7
Figure 5-10. Driver Side Knee Air Bag Deployment Zone	5.7
Figure 5-11. Officer Side Knee Air Bag Deployment Zone.....	5.8
Figure 5-12. Officer Side Knee Air Bag Deployment Zone.....	5.8
Figure 5-13. Driver Side - Side Air Bag Deployment Zone	5.9
Figure 5-14. Driver Side - Side Air Bag Deployment Zone	5.9
Figure 5-15. Driver Side - Rear-Side Air Bag Deployment Zone.....	5.9
Figure 5-16. Driver Side - Rear-Side Air Bag Deployment Zone.....	5.10
Figure 5-17. Officer Side - Side Air Bag Deployment Zone	5.10
Figure 5-18. Officer Side - Side Air Bag Deployment Zone	5.10
Figure 5-19. Officer Side Rear - Side Air Bag Deployment Zone.....	5.11
Figure 5-20. Officer Side - Rear-Side Air Bag Deployment Zone.....	5.11
Figure 5-21. Supplemental Restraint System (SRS).....	5.12
Figure 5-22. APS Components	5.13

Figure 5-23. APS Components Located at Base of Steering Column.....	5.13
Figure 5-24. Under Dash Console.....	5.16
Figure 5-25. OBD Connectors.....	5.17
Figure 5-26. Battery Jumper Terminals.....	5.19
Figure 5-27. Typical E-One Mobile Gateway (If Equipped)	5.21
Figure 5-28. HVAC System Filter Access.....	5.21
Figure 5-29. HVAC System Condensate Drain Lines	5.22
Figure 5-30. Access to Evaporators and Top of Drain Lines.....	5.22
Figure 5-31. Evaporators and Top of Drain Lines.....	5.22
Figure 5-32. Airflow Direction	5.23
Figure 5-33. Evaporators Hose Clamps	5.23
Figure 5-34. Re-install Front and Rear HVAC Covers	5.23
Figure 5-35. HVAC Venturi Drain Maintenance (If Equipped)	5.25
Figure 5-36. Venturi Pump Location	5.25
Figure 5-37. Venturi Pump Location Cab Tilted	5.25
Figure 5-38. Typical Air Intake System - Conventional".....	5.31
Figure 5-39. Typical Intake System - High Air	5.31
Figure 5-40. Typical Cooling System - Integrated Expansion	5.34
Figure 5-41. Typical Cooling System - Overflow Bottle Expansion	5.35
Figure 5-42. Typical Engine Cooling System - Integrated Expansion.....	5.35
Figure 5-43. Typical Engine Cooling System - Overflow Bottle Expansion.....	5.36
Figure 5-44. Typical Positive Deaeration System - Integrated Expansion	5.37
Figure 5-45. Typical Positive Deaeration System - Overflow Bottle Expansion	5.38
Figure 5-46. Typical Integrated Expansion Surge Tank Cutout.....	5.39
Figure 5-47. Coolant Low Level Indicator Orientation.....	5.40
Figure 5-48. Typical Charge Air Cooling System.....	5.43
Figure 5-49. Typical Fan Drive and Shroud.....	5.44
Figure 5-50. Typical Airflow Recirculation Shielding.....	5.45
Figure 5-51. Typical Transmission Sump Cooling System	5.47
Figure 5-52. Typical Transmission Sump and Retarder Combined Cooling System	5.48
Figure 5-53. Typical Exhaust / DPF-SCR Single Module Aftertreatment System.....	5.50
Figure 5-54. Typical Exhaust Routing.....	5.51
Figure 5-55. Typical DPF-SCR Single Module Exhaust Aftertreatment System.....	5.52
Figure 5-56. DPF Warning Lamp	5.54
Figure 5-57. Check Engine Lamp.....	5.54
Figure 5-58. Stop Engine Lamp	5.54
Figure 5-59. High Exhaust System Temperature Lamp	5.55
Figure 5-60. Regeneration Inhibit Lamp.....	5.55
Figure 5-61. DPF Instruction Label.....	5.55
Figure 5-62. Typical Diesel Exhaust Fluid System	5.56
Figure 5-63. Remote Fill for Diesel Exhaust Fluid System	5.57

LIST OF FIGURES

Figure 5-64. Typical Exhaust Tailpipe/Temperature Mitigation.....	5.58
Figure 5-65. Brake Inspection.....	5.60
Figure 5-66. Check Brake System	5.61
Figure 5-67. Wheel Torque Procedure	5.65

Table 4-1: NIOSH Recommended Noise Limits.....	2.11
Table 4-2: Working Zone.....	2.46
Table 4-3: Beaufort Scale (For Reference Only).....	2.55
Table 3-1: Cruise Control Functions	3.5
Table 3-2: Diesel Exhaust Fluid (DEF) (If Equipped)	3.14
Table 3-3: Operational Data	3.22
Table 5-1: Air Bag Deployment Zones	5.6
Table 5-2: U.S. DOT Stroke Limits.....	5.61
Table 5-3: Maintenance for Telma Retarders (If Equipped)	5.62
Table 5-4: Recommended Maintenance Practices.....	5.66
Table 5-5: Driver's Daily Inspection.....	5.69

For future use

GENERAL INFORMATION

VEHICLE IDENTIFICATION NUMBER

When filing a warranty claim, submitting a complaint, or general inquiries, you will need to provide the last eight digits of the vehicle identification number (VIN) as stated on the label.

If you have a question regarding your chassis, or this manual, please contact the E-One Customer & Product Support at 1-800-627-5050 option 1.

CHASSIS WARRANTY AND REGISTRATION

The prompt return of the Limited Warranty Registration in the front of this manual will allow servicing of the chassis under warranty, should a warrantable condition exist. The most effective way to submit our Chassis Registration Form is through our website, www.spartanmotors.com, under the customer & product support tab. If a computer is not available, complete the paper form and mail to the address below.

E-ONE
Customer & Product Support
1601 SW 37th Avenue
Ocala, FL 34474

THE CHASSIS LIMITED WARRANTY IS NOT VALID, AND REMAINS NULL AND VOID, IF THE LIMITED WARRANTY REGISTRATION PROCESS IS NOT COMPLETED WITHIN (30) DAYS AFTER THE DATE OF RETAIL PURCHASE. IF YOU ARE NOT SURE WHETHER YOUR WARRANTY IS STILL IN EFFECT, OR HAVE OTHER QUESTIONS ABOUT WARRANTY COVERAGE, PLEASE CONTACT THE SPARTAN CUSTOMER & PRODUCT SUPPORT.

EMISSIONS WARRANTY

Engine emissions and aftertreatment systems are warranted by the engine manufacturer for five (5) years or 100,000 miles. (see your engine emissions warranty for details).

In conformance with 40CFR§1037.120 your custom chassis apparatus is warranted to the ultimate purchaser and each subsequent purchaser as follows:

- The tires delivered with this new vehicle will be free from defects in materials and workmanship that cause the vehicle to fail to conform to the requirements of 40CFR§1037 Control of Emissions from New Heavy-Duty Motor Vehicles for two (2) years or 24,000 miles.
- Engine emissions related components and air conditioning refrigerant sealing components will be free from defects in materials and workmanship that cause the vehicle to fail to conform to the requirements of 40CFR§1037 for five (5) years or 100,000 miles (see your apparatus emissions warranty for details).

MAINTENANCE RECORDS

It is the owner's responsibility to keep accurate maintenance and repair records, including receipts. Should the lack of required maintenance be the reason for repair, a warranty claim will not be accepted. E-One reserves the right to request your maintenance and repair records for verification of compliance with required maintenance practices and intervals.

GENERAL INFORMATION

E-One recommends maintenance and repair records/receipts be maintained as permanent records and kept in a secure location. Acceptable records include itemized bills, dealer work orders, owner's vehicle log, and service facility receipts, which must state the date service was performed Vehicle Identification Number (VIN), mileage (kilometers), engine hours, and service performed.

NOTICE

Through out this manual the term "routinely" is used to describe certain maintenance intervals. Routine maintenance interval may be dependent on vehicle usage, for such recommended activities the user shall define intervals.

E-One recommends referencing: **NFPA® 1910** *Standard for the Inspection, Maintenance, Refurbishment, Testing, and Retirement of In-Service Emergency Vehicles and Marine Firefighting Vessels* for completed apparatus maintenance recommendations.

USE OEM PARTS FOR REPAIR

Your chassis is designed to operate as a system. Every part has been selected to ensure proper performance. Use of repair parts other than those provided by your E-One authorized repair facility will void warranty. Use only E-One OEM parts for service or repair.

VEHICLE DATA RECORDER (VDR) SYSTEMS

Your vehicle may be equipped with a Vehicle Data Recorder (VDR) System. The VDR records information including, but not limited to, the following information:

- | | |
|---|--|
| • Maximum vehicle speed | MPH |
| • Maximum acceleration (from speedometer) | MPH/Sec |
| • Maximum deceleration (from speedometer) | MPH/Sec |
| • Maximum engine speed | RPM |
| • Maximum engine throttle position | Percentage of full throttle |
| • ABS Event | On/Off |
| • Seat occupied with seat belt unbuckle | Yes/No by position at 30 seconds into minute |
| • Master Optical Warning Device Switch | On/Off at 30 seconds into minute |
| • Time | 24 hour time |
| • Date | Year/Month/Day |

To access data stored in the VDR, electronic equipment is necessary. Software is available for your access to this system. For more information, contact E-One Customer & Product Support.

Gross Vehicle Weight Rating (GVWR)

The GVWR is the rating established by E-One as the maximum weight of the vehicle (including cargo, passengers, liquids, etc.), or the load carrying capacity, that the components of the vehicle are designed to support. This rating excludes any towed item.

Gross Combination Weight Rating (GCWR)

Gross Combination Weight Rating - A value specified by the manufacturer of the power unit, if such value is displayed on the Federal Motor Vehicle Safety Standard (FMVSS) certification label required by the National Highway Traffic Safety Administration, or

The sum of the gross vehicle weight ratings (GVWRs) or the gross vehicle weights (GVWs) of the power unit and the towed unit(s), or any combination thereof that produces the highest value.

Gross Axle Weight Rating (GAWR)

The GAWR is the maximum weight **rating** that an axle assembly is designed to support, the load-carrying capacity. Axle assembly components include the axle, suspension, tires, wheels, and brakes. Weight distribution on an axle **must** be as equal side-to-side as possible to avoid overloading one side. Therefore, individual wheel position weights **must** be taken to avoid this condition. If one side is overloaded by more than 5% of the total axle rating (GAWR), it is necessary to redistribute the load appropriately. For example, if the GAWR of one axle on your vehicle is 10,000 pounds, 5% of that is 500 pounds. This means that the actual weight difference between the left and right side of the axle **must** be within 500 pounds. In addition, the actual weight on one side of a single axle must never exceed 50% or 1 half of the GAWR for that axle, which would be 5000 pounds for the preceding example. Refer to the axle manufacturer's literature for additional information.

CAB SEATING LAYOUT IDENTIFICATION

Use this numbering system when communicating seat locations. If your cab is not equipped with a seat in a particular location, the seat number remains the same.

e.g. if you do not have seats in locations 4 and 5, the seat behind the officer will still be seat 6).

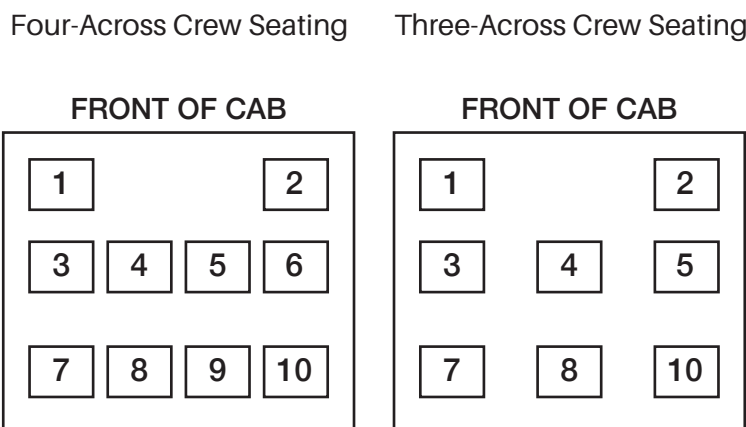

Figure 1-1. Cab Seating Layout

For future use

GENERAL SAFETY

INTRODUCTION

Operator Manuals

This operation and service manual is one in a set of manuals that instructs you on how to properly and safely operate an apparatus. For a complete understanding of the safe and proper operation of your apparatus you must read, study, understand, and follow the information found in each of the manuals provided to you.

These may include the following:

- Custom Chassis.
- Commercial Chassis.
- Aerial Device.
- Pumping System.

These manuals do not replace, nor does their use absolve you from complying with any and all applicable Federal, State, or Provincial regulations, safety codes, operating limitations, fire company procedures or insurance requirements.

Major Component Manuals

Additional safety, operation, and service information is located in the associated major component operation and service manuals. Study the safety information found in all the manuals provided including manuals for the engine, transmission, pump, breathing air system, foam system, generator, and others included in the information provided with the delivery of your apparatus.

Industry Standards and Guidelines.

There are many industry standards and guides that you and your department must follow to safely operate your apparatus including those shown here.

- **NFPA® 1900** *Standard for Aircraft Rescue and Firefighting Vehicles, Automotive Fire apparatus, Wild-land Fire Apparatus, and Automotive Ambulances*
- **NFPA® 1910** *Standard for the Inspection, Maintenance, Refurbishment, Testing, and Retirement of In-Service Emergency Vehicles and Marine Firefighting Vessels*
- **NFPA® 1451** *Standard for a Fire and Emergency Service Vehicle Operations Training Program*
- **NFPA® 1500** *Standard on Fire Department Occupational Safety, Health, and Wellness Program*
- **NFPA® 1962** *Standard for the Care, Use, Inspection, Service Testing and Replacement of Fire Hose, Couplings, Nozzles, and Fire Hose Appliances*
- **IFSTA** *Pumping and Aerial Apparatus Driver/Operator Handbook*
- **FAMA** *Fire Apparatus Safety Guide* (additional copies available from FAMA.org)
- **FEMA** *Safe Operation of Fire Tankers* (downloadable from FEMA.org)

SAFETY

- **PSHSA** *Electrical Safety Handbook for Emergency Responders* (Public Services Health and Safety Association of Canada, www.pshsa.ca)

Apparatus Modifications

Modification of this apparatus from its original design without written permission from the manufacturer is strictly prohibited and may result in subjecting personnel to a risk of injury or death. The manufacturer reserves the right to change, improve, modify or expand features of its products at any time, without notice, and without incurring any obligations to change, improve, modify or expand features of previously delivered equipment.

EXTRICATION AND AIR BAGS

Your apparatus may be equipped with occupant roll-over or front crash protection airbags and other pyrotechnic devices that may deploy during a rollover or frontal crash.

In case it is necessary to perform the extrication of an occupant of this vehicle, performing any one of the following will disable the roll or frontal sensors and any unfired protective devices:

- Turn battery master switch to the OFF position, OR
- Move ignition switch to the OFF position, OR
- Disconnect the batteries, OR
- Cut the wires to the protective device actuators.

Fired protective devices pose no toxic threat to rescue personnel. After a side roll accident, the seat belts on all the occupants will be tight, but have specially designed buckles that can be released under belt tension. Use extreme care when releasing seat belt buckles and exiting a damaged vehicle. The bags will be filled with warm inert gases. The gases will be nearly invisible, but will have an acrid smell. The gases pose no harm to occupants or rescue personnel.

TO THE APPARATUS DRIVER/OPERATOR

A custom fire apparatus is not a consumer product; it is a complex piece of industrial equipment. It has the potential to harm you or those around you if you use it improperly. Safe operation requires you to be trained, be experienced, be smart and use your common sense. It is essential that you be careful, physically and mentally qualified, trained in the safe operation of this equipment, and authorized by your fire department to do so.

Never work on or around a fire apparatus, or operate it, unless you have:

- Read and understood this operation and service manual.
- Watched and understood any safety video(s).
- Read and understood any other operation and service manuals associated with your apparatus.
- Read and understood the operation manual(s) of components supplied with this apparatus.
- Read and understood the **FAMA** Fire Apparatus Safety Guide.
- Read and understood all safety signs posted on your apparatus.

- Been trained in the safe operation of this apparatus in accordance with **NFPA® 1451** *Standard for a Fire and Emergency Service Vehicle Operations Training Program*.
- Been properly trained and are authorized to operate your apparatus.

If you do not feel comfortable with your knowledge, training, level of experience or the adequacy of your personal protective equipment, stop what you are doing and report this to your supervisor. If you feel that the apparatus is not functioning safely, stop what you are doing, report it to your fire department safety officer or fire chief, and do not use the apparatus until the hazardous situation can be resolved.

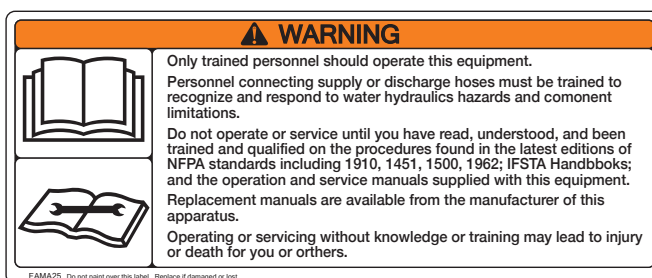

TO THE APPARATUS MECHANIC

Fire apparatus are complex machines made of thousands of parts. As with all machines, they must be constantly maintained and can break down. The safety of the firefighters using your apparatus, as well as the safety of people in your community, depend on frequent and thorough inspection, service and maintenance of your apparatus and its associated equipment. Since you will probably need to operate your apparatus in the course of servicing it, you must be intimately familiar with safe methods of operation as well as safe maintenance practices.

If you do not feel comfortable with your knowledge, training, level of experience or adequacy of your personal protective equipment, stop what you are doing and report this to your supervisor. If you feel that the apparatus is not functioning safely, stop what you are doing, report it to your fire department safety officer or fire chief, and do not use the apparatus until the hazardous situation can be resolved.

Never attempt to service or maintain a fire apparatus unless you have:

- Read and understood the **FAMA** Fire Apparatus Safety Guide.
- Watched and understood any applicable safety video(s).
- Read and understood this operation and maintenance manual(s).
- Read and understood the operation and maintenance manual(s) of components supplied with your apparatus.
- Been properly trained and are authorized to maintain and operate your apparatus.

TO THE SAFETY OFFICER

NFPA 1521 *Standard for Fire Department Safety Officer* establishes specific and essential responsibilities for your role relating to the safe operation of fire apparatus in your department. You are expected to participate in the specification of new apparatus to ensure that the apparatus will include safe features consistent with the way your department will operate. You are also expected to monitor your apparatus while it is being used to make sure that the firefighters using your apparatus are doing so in a safe manner.

SAFETY

The highly custom nature of fire apparatus makes your role and responsibilities extremely important. Fire department operations vary greatly and we cannot anticipate all the potential ways your apparatus may be used. It is your responsibility to make sure the ways your department operates are consistent with the instructions in this manual. Where a custom feature is not covered, it is your responsibility to make sure safe practices are established and followed. It is essential that you anticipate the way your department personnel will use your apparatus and how it is actually being used once it is placed in service. A custom feature, or a common feature installed in an uncommon fashion, may present a hazard that was not apparent at the time of manufacture. If you observe anything that you feel is unsafe, it is your responsibility as established by **NFPA 1521** to address it. Contact us if you need help and we will work with you to ensure that your apparatus is safe in every regard.

TO THE TRAINING OFFICER

NFPA® 1451 *Standard for a Fire and Emergency Service Vehicle Operations Training Program* establishes specific and essential responsibilities for training in the safe operation of fire apparatus in your department. Personnel must never be allowed to operate an apparatus unless you are convinced that they have been thoroughly trained in its safe operation, and they are experienced enough to operate safely all the time without supervision. They must be trained to operate safely all the time, not cut corners, not operate the apparatus in ways it was not intended, and not be careless with the safety of themselves or others. **NFPA® 1451**, Annex B offers a detailed checklist of potential hazards found on apparatus that every operator must be trained to avoid.

TO THE FIRE CHIEF

As with any piece of complex industrial equipment, your apparatus is designed to be operated only by trained, experienced and sophisticated users. Many fire chiefs have had to deal with tragic outcomes when apparatus have been placed in the hands of poorly trained, inexperienced or undisciplined personnel. Such mistakes can result in injury or death to firefighters, the victims you are intending to rescue or innocent bystanders. It is essential that you support your safety and training officers, foster a culture that promotes safe operation and provide consequences for those who choose not to follow the rules.

Parades and Public Events

Your apparatus is designed for personnel to be transported only while wearing seatbelts. Transporting people who are not seated and belted should never be allowed. Before using your apparatus in parades, educational demonstrations, charitable fundraisers, or other community events where untrained people will be in, on, or around your apparatus you must create a safety plan that will protect them from harm. Before allowing anyone other than a trained and experienced member of your department near your apparatus, you should consult with your fire department safety officer and plan for safety. Be sure to follow all the safety procedures in this manual, and ensure that the event will be conducted in a manner that is safe for everyone involved.

Not Designed for Children

Your apparatus is designed for adult fire fighters and is not suitable for the transportation of children. Your apparatus is compliant to the Federal Motor Vehicle Safety Standards that apply to trucks over 10,000 lbs. These standards expect that operators are adult professions and they do not account for the needs of children. Features including the following may not be appropriate for accommodating children or people of extremely small stature.

- SCBA Seating.
- Seat Belt Accommodations.
- Inflatable Occupant Restraints.
- Power Window Controls.
- Child Seat Attachments.

Vehicle Data Recorder

Your **NFPA® 1900** compliant apparatus includes a Vehicle Data Recorder (VDR). This device allows you to download data from your apparatus that will tell you certain safe driving information such as whether your apparatus is driving too fast, stopping too quickly, or being operated with unbelted occupants. The intention of this device is to assist you in monitoring, training, and enforcing safe apparatus driving practices. Download and use this data regularly to ensure that the personnel under your supervision are operating safely.

SAFETY ALERTS

The safety signs found on your apparatus and in this manual use the ANSI Z535 safety alert symbol system. You should be familiar with this system and understand the meaning of each symbol.

Safety Alert Symbol

The Safety Alert Symbol means: "ATTENTION! STAY ALERT! YOUR SAFETY IS INVOLVED!".



The Safety Alert Symbol identifies important safety messages on your apparatus, on your equipment, on safety signs, in manuals or elsewhere. When you see this symbol, be alert to the possibility of death or personal injury. Follow instructions in the safety message.

Signal Words

Signal words are intended to alert you of a potential hazard, the general severity of the hazard and that a message will follow which will provide instruction on how to avoid the hazard.



Danger: Indicates a hazardous situation which, if not avoided, **WILL** result in death or serious injury.



Warning: Indicates a hazardous situation which, if not avoided, **MAY** result in death or serious injury.

CAUTION

Caution: (without safety alert symbol) Indicates a situation which, if not avoided may cause equipment damage.

FOLLOW A SAFETY PROGRAM

Turnout gear is important any time you are operating on or around your apparatus. Your fire apparatus is heavy equipment, and PPE is appropriate any time you are using it.

You may need:

- Boots.
- Helmet.
- Heavy-duty gloves.
- Reflective clothing.
- Hearing protection.
- Safety glasses, goggles or face shield.

Always Be Alert

As a first responder you are trained to be situationally aware. This means you are always looking out for what is around you even in the midst of an emergency. This awareness is just as important during mop-up, training, testing, cleaning, service, maintenance or any other time you are working in, on or around your apparatus. Don't be tempted to forget the importance of being aware and alert when there is no emergency. Many injuries occur during routine operations when your guard is down. You may be tempted to relax around the apparatus when performing tasks you have done many times before. Avoid this temptation. Your equipment must be respected at all times for your safety and the safety of those around you.

Be Careful

Mistakes are more likely when you are tired, distracted, or overwhelmed. Call in extra assistance and let someone else take over if you become fatigued or ill. Never operate on or around your apparatus under the influence of drugs or alcohol. Operating your apparatus in an un-well condition can lead to death or injury for you or others.

Know the Rules

Your department will have rules and procedures to keep you safe. These must include the instructions in this manual. Know the rules and follow them. If you find a conflict in the rules work with your department's safety officer to resolve the conflict.

Commercial Driver's License Course

Your state may exempt you as a firefighter from the requirement to hold a commercial driver's license (CDL), but the rig you are driving may be bigger and heavier than most other trucks on the road. Commercial drivers must learn the right way to inspect and operate heavy trucks and demonstrate their abilities before they are issued a license. Consider taking these courses and obtaining your CDL even if not required to do so by your department. You will learn valuable safety tips, demonstrate your skills and feel more confident behind the wheel of your apparatus.

Practice Safe Practices

It is not enough to simply be instructed on safe apparatus operation. Consistently safe operation happens because you know how to operate safely and have practiced safe operation long enough to establish safe habits that are committed to both your mental memory and your muscle memory. Never cut corners in safety during practice sessions to avoid unintentionally cutting corners during an emergency.

Safety Signs

Read and understand all the safety signs on your apparatus before you operate the equipment. They communicate the most critical safety messages, but they are meant to remind only. You should know, memorize, and follow the instructions without needing to read them during operation.

Operate Only What You Know

Your apparatus may have unique characteristics or features that were custom ordered by your department. Other apparatus in your fleet may have different unique characteristics or features. Only operate an apparatus that you are completely familiar with and that you have been trained and authorized to use safely.

Operate Only Well Inspected Apparatus

Your apparatus must be in excellent working order at all times if you are going to ensure your own safety and the safety of others.

Follow the **NFPA® 1910 Standard for the Inspection, Maintenance, Refurbishment, Testing, and Retirement of In-Service Emergency Vehicles and Marine Firefighting Vessels** and your manufacturer's operation and service manuals to keep your apparatus safe for operation. These publications will tell you what to check, what to test, how often they need to be checked or tested, and when you should remove your apparatus from service.

Your apparatus should be inspected thoroughly on a regular basis. Study the inspection criteria found in this manual, the other applicable operator manuals, the decals and markings on the apparatus itself, and your State's commercial driver's license pre-trip inspection requirements. Determine how each requirement will apply to your apparatus and consolidate this data into a single pre-trip or start-of-shift inspection. Determine when and by whom the inspections will be performed, make sure these individuals are trained and qualified to perform the inspections, and establish a regular inspection schedule. Make sure you perform each inspection in teams of two, with one person operating interior controls while the second person is checking for exterior functions such as turn signal lamps, flashers, brake lights, etc.

Record all deficiencies in compliance with **NFPA® 1910 Standard for the Inspection, Maintenance, Refurbishment, Testing, and Retirement of In-Service Emergency Vehicles and Marine Firefighting Vessels**. Review the previous inspection report at the start of each shift to ensure that any deficiency that was noted by the previous crew has been resolved.

SAFETY

GENERAL HAZARD IDENTIFICATION

Your apparatus will have safety signs warning of the more common hazards, but not every hazard will be identified with a safety sign. You must use your common sense. Look for and avoid these general hazards. Study your apparatus to identify each hazard and develop methods of avoiding each. It is best to make this a written plan so that you can share it with all the personnel who may be working on or around your apparatus.

Jewelry and Loose Personal Items

Loose fitting clothing, long hair, dangling jewelry and rings may catch on the apparatus or be pulled into moving equipment. Personnel working on or servicing fire apparatus should avoid wearing loose fitting clothing, long hair, dangling jewelry and rings which may catch on the apparatus or be pulled into moving equipment. Wear gloves, safety glasses and other PPE that protects you from the potential hazards of the task you are performing.

Pinch and Crush Hazards

Look for places where there are moving parts such as folding steps, aerial ladders, rollout shelves, aerial turntables, stabilizers, cab and compartment doors, etc.

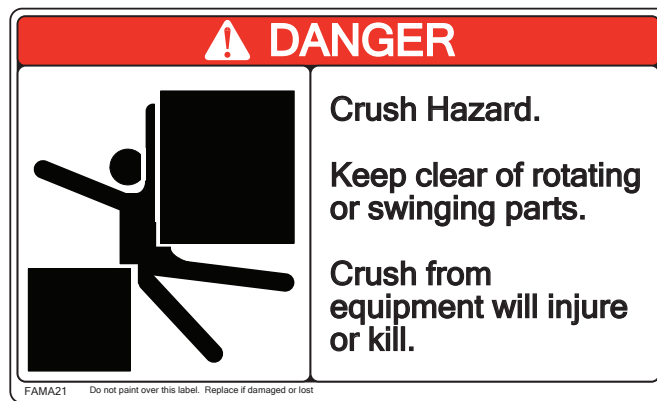

Rotating Parts Hazards

Common rotating parts include; drive shafts, power take-off shafts, cooling fans, compressors, generators and hose or cord reel drives. Do not wear loose clothing or other items that could get tangled in the shafts or fans. Many rotating parts can begin to spin without warning; therefore, treat each hazard as if it were spinning already.

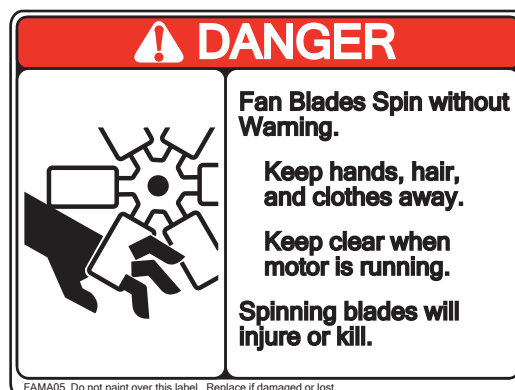

Hot Parts Hazards

Common hot parts include; engine, exhaust, air compressors, water pumps, air conditioning compressors, foam pumps, line voltage generators, and fuel-fired heaters.

Diesel engines equipped with diesel particulate filters require regeneration that involves high heat. The exhaust system can get extremely hot without warning. Keep away from exhaust gas and do not park your apparatus where the exhaust pipe points toward or near flammable material.

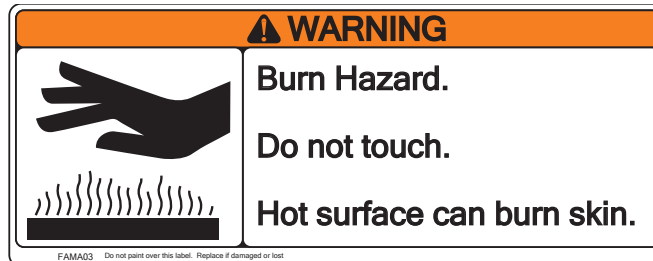

Exhaust Fumes

Internal combustion engines give off hazardous fumes while running. Never run your apparatus engine inside a building unless the exhaust discharge is connected to an extraction system. Diesel engine exhaust and some of its constituents are known to the State of California to cause cancer, birth defects and other reproductive harm. Do not operate any internal combustion engine in an area where exhaust gases can accumulate or serious injury or death may occur. If exhaust fumes are suspected of entering the vehicle cab, rectify the defect immediately. Do not perform a DPF regeneration inside a building. Do not stay inside your parked apparatus cab for extended periods of time with the engine running as exhaust fumes could seep into the cab causing illness or death.

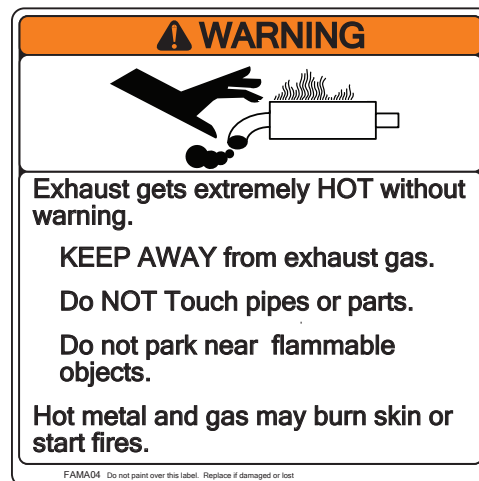

SAFETY

Chemical Exposure

Your apparatus could expose you to chemicals that the State of California has determined can cause cancer. Avoid exposure to these chemicals including Diesel Exhaust, Gasoline Exhaust, and Gasoline Vapors. Check with the California website to learn more at <https://oehha.ca.gov/proposition-65/chemicals>.

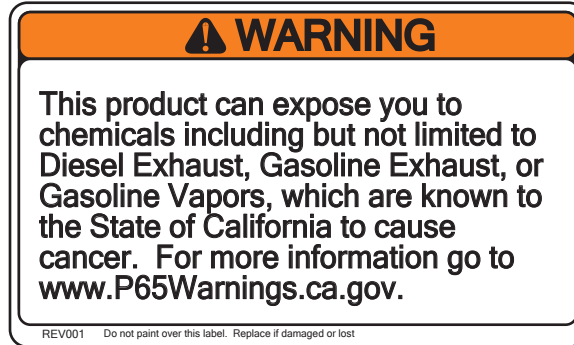

Fire

Your apparatus is composed of many parts that can catch on fire. These include fuel, oils, plastics, rubber, vinyl and cloth. It also has a source of ignition in the form of batteries and electrical wiring. Chaffed wires can cause heat or sparks that can start a fire. Avoid parking your apparatus, or any other motor vehicle, inside any structure that has common walls with a sleeping area. Install fire alarms and sprinklers in garage bays. Make sure that your apparatus is well maintained and that hot components and wire harnesses are kept free of grease, oils and other contaminants. Clean all build-up of oily or greasy dirt that can burn and spread a vehicle fire quickly.

If your apparatus catches on fire while driving:

- Bring vehicle to a complete stop as quickly as possible.
- Apply parking brake.
- Shut down engine.
- Turn off master power switch.
- Leave vehicle.

Electrical Shock

Your apparatus may be equipped with line voltage capability (120 V, 240 V, etc.). Common sources of line voltage include invertors, gas or diesel generators, generators driven by power-take-off shafts from the main engine, or hydraulically powered generators. You will also have line voltage on board while you have your apparatus plugged in to shore power.

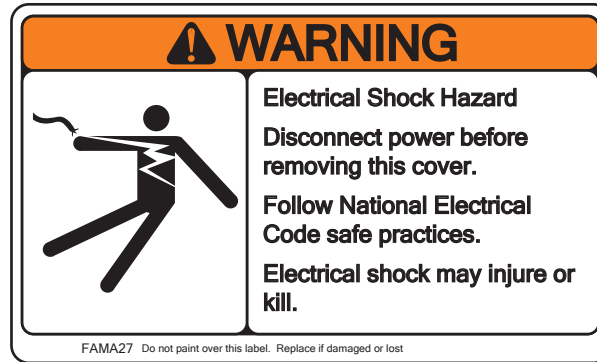

Noise

Your apparatus may be equipped with audible warning devices that create loud noise to clear traffic. There may be local and state laws in your area governing the use of such devices. Use the city horn instead of the air horns and sirens unless needed.

Sirens produce loud sounds that may damage hearing:

- Roll-up windows.
- Wear hearing protection.
- Use only for emergency response.
- Avoid exposure to siren sound.

Do not operate sirens or air horns with personnel standing in the immediate vicinity (within 50 feet) of the front of your apparatus.

Always use hearing protection such as ear plugs, muffs, or noise canceling intercom headsets to keep your noise exposure within the following NIOSH recommended limits.

Table 4-1: NIOSH Recommended Noise Limits

Duration Exposure per day (Hours)	TWA A-weighted SPL (db)
8	85
4	88
2	91
1	94
1/2	97
1/4	100
1/8 (7 min. 30 sec.)	103
1/16 (3 min. 45 sec.)	106
1/32 (1 min. 53 sec.)	109

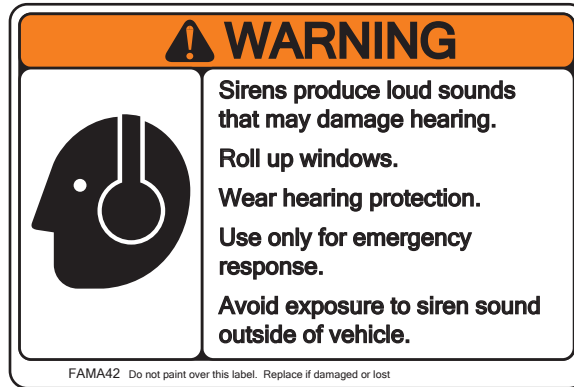

Establish a departmental hearing conservation program to monitor the hearing levels of fire department personnel in accordance with the guidelines found in **NFPA 1500 Standard on Fire Department Occupational Safety, Health and Wellness Program**.

Your apparatus is equipped with noise suppression components as part of the engine emissions system and powertrain. Do not remove or disable noise suppression components for any purpose other than maintenance, repair, or replacement.

Undercarriage

Use special caution if you need to be underneath your apparatus for any reason. The bottom of your apparatus is not designed to be an operational area, and there are many hazards you will encounter including rotating drivelines, PTO shafts, hot exhaust, pumps, and components which may emit hot steam or chemicals. Inform others and use lock-out tag-out procedures before working beneath your apparatus.

CUSTOM CHASSIS SAFETY

Understand Your Operating Environment

Know Your Response Area

Your apparatus is higher, heavier, longer, and wider than many other vehicles on the road. State and Federal regulations allow fire apparatus to have higher axle weights than other commercial vehicles. These factors mean that you need to be more careful than other vehicles about where you can safely operate.

Drive your streets in your apparatus and plan your routes around the size, weight, and capability of your apparatus.

NOTICE

Any areas where your apparatus should not be driven. Plan response routes to cover your district while avoiding these hazards.

Pay special attention to the following:

- Road weight limits.
- Bridge weight limits.

- Low overhead wires.
- Low trestles, bridges, and under-passes.
- Low traffic signals.
- Railroad crossings.
- Cul de sacs, dead ends, and turn-arounds.
- Narrow roads and alleyways.
- Narrow roads with steep drop-offs or soft shoulders.

Know Your Climate

Like any other machine, fire apparatus may require special consideration in inclement weather. High winds, freezing rain, flooding, snow, ice, as well as extreme heat or cold, can all present special challenges to safe operation. Think about the types of extreme weather common to your area and make a list of the special hazards these may present. You will find many weather related precautions throughout this manual. Identify special procedures to counter extreme conditions and practice them while in good weather so that you know what to do when nature turns against you.

Know the Rules of the Road

Your local laws may allow you more road privileges than the general public, but they do not change the laws of physics. You must know the limitations of your apparatus, respect these limitations and drive defensively at all times. Your apparatus is a heavy vehicle that will take more time to accelerate, more distance to stop and is less stable in turns than your passenger vehicle. Heavy axle weights will make it more likely that if you wander onto a soft shoulder you will be drawn off the road and into a ditch. Always drive your apparatus safely and deliberately. The few extra minutes you save running the red light or driving fast through the curves will be lost if you don't arrive safely.

Check the operation of your lights and sirens prior to the start of each shift. Do not rely on your audible and visual warnings to clear the right of way. People may not hear, see or heed your warning signal. You must recognize this fact and continue driving cautiously.

Traffic Signal Capturing

Your apparatus may include a system that works with your local traffic control signals to increase the potential that you will always get a green light at a controlled intersection. While such systems are useful to improve your response time, they are not foolproof. Like any mechanical or electrical system they are susceptible to failure. It is also possible that your apparatus gets pre-empted by another emergency vehicle with a higher priority. You should, therefore, never assume that you will get a green light. Always obey traffic signals.

SECURING EQUIPMENT

Secure Interior Equipment

If your apparatus crashes it will stop quickly, but items inside the cab will keep going at the speed the apparatus was traveling prior to the crash. Only store items in a cab that can be secured in compartments or in strong brackets. The compartment or bracket should be able to hold the item even if you pull on it with a force equal to nine times its weight.



Secure Exterior Equipment

Ground ladders or other equipment that falls off your apparatus can injure or kill drivers or pedestrians in your path. Make sure that every compartment door is closed and secured and every piece of equipment is locked in its bracket before you drive away. Inspect compartment door hardware and equipment brackets regularly to make sure your equipment stays on the apparatus where it belongs.

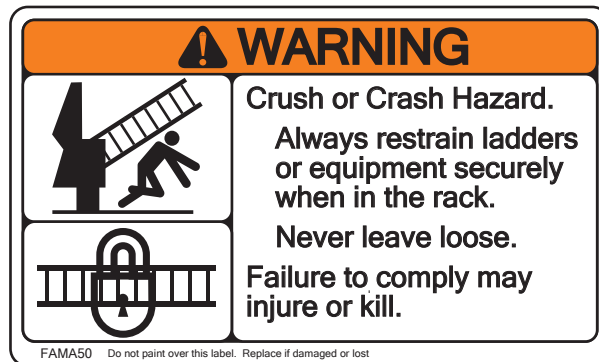

Restrain Hose

Your apparatus includes a hose restraining method for all your designated hose storage areas. Hose that falls off your apparatus can injure or kill drivers or pedestrians in your path. Never drive your apparatus without the hose restraints securely in place.



WORKING ON TOP OF YOUR APPARATUS

Slips, trips and falls are one of the most common ways of being injured when working around your apparatus.

Avoid Climbing and Walking on Top

Avoid the need to climb on your apparatus by locating items you need to access during emergency operations in compartments that can be reached from the ground. Store equipment above ground level only that you can access in the station or other controlled environment where you can use safety ladders, lifts, or use fall protection equipment to retrieve them.

Clean From the Ground

Perform routine windshield, cab glass, and mirror surfaces from the ground using brushes and squeegees mounted on extension poles. When better access is necessary for washing the entire apparatus use platforms, safety ladders or other means to avoid climbing on wet slippery surfaces.

Use Three Points of Contact

Three points of contact means you have one hand and two feet, or two hands and one foot in contact with the vehicle at all times. If you can't find sturdy features to provide three points of contact, have the vehicle modified or repaired. When climbing, it is very difficult to maintain three points of contact without facing the vehicle. Always face your apparatus when getting on and off. Backing out is much safer.



SAFETY

Clean and Repair

Keep steps, walking surfaces, hand rails and shoes free of grease, mud, dirt, fuel, ice and snow. Inspect your apparatus steps, walking surfaces, and handrails frequently. If defects are found remove the apparatus from service until repairs can be made.

Slip Resistant Surfaces

The NFPA standards specify the performance that slip resistant surfaces must meet. Only step or walk on surfaces that are slip resistant. If you must walk or work on a surface that is not slip resistant, do so only in a controlled environment using fall protection equipment. In addition to fall restraint devices, use rubber mats or other means to keep you from slipping.

Designated Stepping, Standing and Walking Surfaces

If your apparatus was contracted for after January 1, 2016, it will have designated standing or walking surfaces at any location above 48 inches from the ground where you may need to access during normal operation.

You can tell which surfaces are designated for standing or walking as follows:

- The surface will have a slip resistant surface. (Except for hose storage areas). AND...
- The surface will have a yellow or orange line surrounding it. OR...
- The surface will have railings or structure at least 12.0 in. (304.8 mm) high surrounding it.

Do not stand or walk on any feature of your apparatus that is over 48.0 in. (1,219.2 mm) above the ground unless it meets these criteria. Any surface over 48.0 in. (1,219.2 mm) high that does not meet these criteria must only be accessed using service ladders and a fall protection system or other safe means as determined by your fire department safety management personnel.

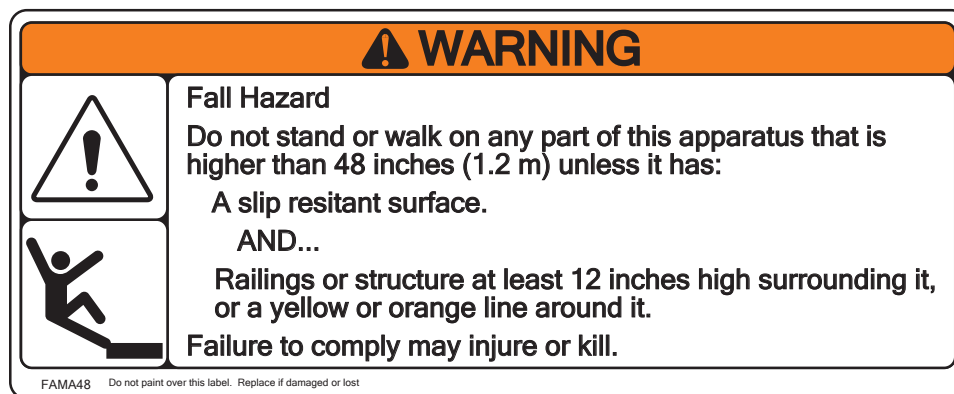

Some surfaces, such as diamond plate or tread plate may be used in construction of features that are not intended to be walked on. It may be used for aesthetic appeal, or to protect painted surfaces from wear. Just because a surface is constructed of diamond plate or tread plate does not mean that it is designated to be walked or stepped upon.



Folding Steps or Ladders

Certain steps or ladders may be of a pivoting or folding design. They may deploy automatically, or they may need to be deployed by hand. In either case, make sure they are firmly engaged in the weight bearing position before using them. Also make sure they are stowed again before placing the vehicle in motion.



Open Compartment Doors

When climbing or walking on the vehicle, never step on a horizontally hinged cover or compartment door that has been left open. Hold-open devices are not designed to support more than the weight of the door itself. Also, never step on the edge of a vertically hinged door that has been left open. In either case the doors will move and you are likely to fall.

Working on Top of the Apparatus

For those times when working on the top of your apparatus is unavoidable, you must use extra precaution from the moment you leave the ground.

- Stay away from the edge.
- Always use three points of contact.
- Only step on surfaces that are slip resistant.
- Never step on open, horizontal compartment doors.
- Never step on open, vertical compartment door edges.

SAFETY

Climbing Prohibitions

Do not step or climb upon any vehicle surface unless it is slip resistant and handholds are provided. Never climb using features on your apparatus such as lights, sirens, inlet or outlet valves, controls, compartment doors, or other non-climbing features.

Working Around the Apparatus

Open compartment doors that extend out from the vehicle may create a head-strike hazard to others working in the area. Take the time to close compartment doors after you have retrieved your equipment. This goes the same for other items that hang off the apparatus such as deployable ladder racks, slide-out shelves, hose trays, portable tank racks, etc. If you are working at night, be sure to light up the area to reduce the risk of running into things.

- Use scene lights during night operation.
- Always wear your fire helmet when working around your apparatus.
- Keep compartment doors, trays and equipment racks closed or stowed when not in use.

RIDE SAFELY

Cab Capacity

Your apparatus cab is designed to carry a maximum number of occupants while it is in motion. Never place the apparatus in motion with more than the maximum number as designated on the label in the cab and never without every occupant seated and belted.

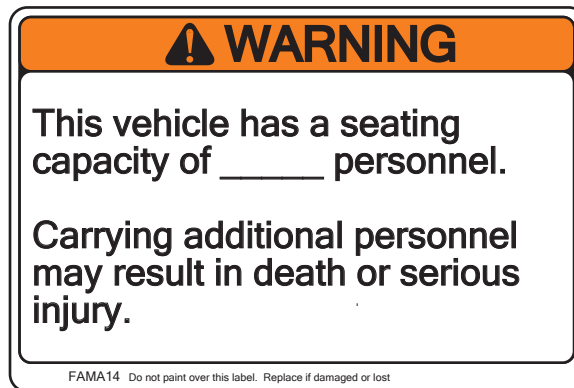

Seat Belts

Wearing your seat belt is the single most important thing you can do to keep yourself safe while riding in a fire apparatus. Put your gear on before you ride or plan to put it on after you arrive on the scene. Follow these rules to minimize your risk of injury during a crash:

- Always wear a seat belt when the vehicle is in motion.
- Ride with the seat back upright and your lap belt snug and low about the hips.
- Keep your shoulder belt snug against your chest.
- Never wear your shoulder belt under your arm or swing it around your neck over the inside shoulder.

- Never use a single belt for more than one person or one seating position.
- Place your seat belt inside the cab before closing the door.
- Have your belts replaced if they are damaged or worn.



Seat Back Position

Do not drive or ride with your seat back reclined. Your seatbelt may not function properly in a crash if the seat is reclined.

Shoulder Belt Positioning

If your seat belt is equipped with a height adjuster, use it to move the shoulder belt into the proper position as shown.

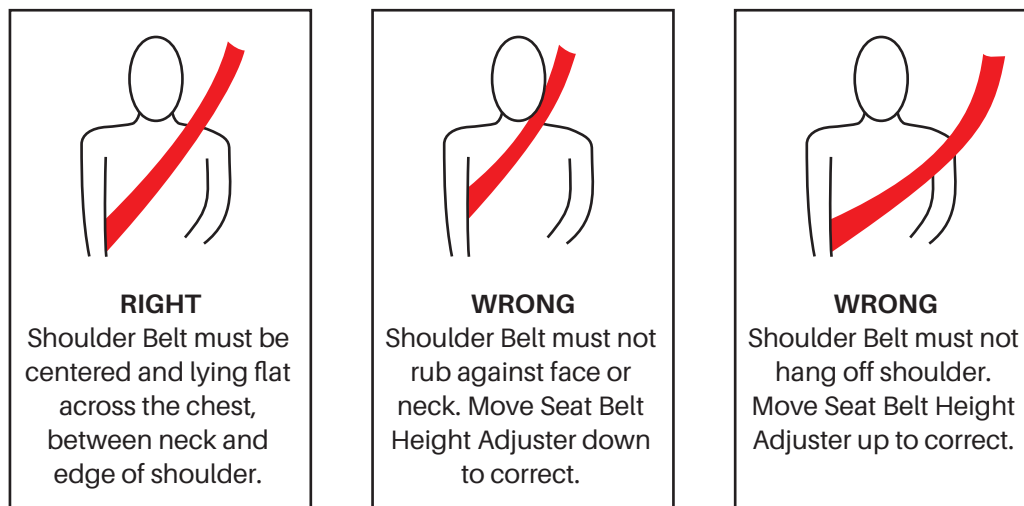

Safest Posture

Seat belts provide the best restraint when:

- Seat back is upright.
- Occupant is sitting upright; not slouched.
- Lap belt is snug and low on the hips.

SAFETY

- Shoulder belt is snug against the chest.
- Knees are straight forward.

Seatbelt Sliding Komfort Latch®

Your apparatus seat belts may be equipped with the Sliding Komfort Latch[®] that allows you to introduce a small amount of slack in the belt to relieve pressure on your chest while driving.

- Do not introduce more than 1.0 in. (25.4 mm) of slack when using the Sliding Komfort Latch[®].
- Using the seat belt with too much slack can reduce its effectiveness during a crash.
- Always disengage the Sliding Komfort Latch[®] when removing the seat belt to allow the seat belt to fully retract.

Transporting Children

Your apparatus occupant protection systems are designed to accommodate adult firefighters who may be wearing protective gear. It is not designed for transporting children. Do not transport children in your apparatus, they should be transported in appropriate passenger vehicles only.

Seats Without Seat Belts

Your apparatus may be equipped with work areas that include seats without seat belts. These seats are meant to be used only when the apparatus is stopped with the parking brake applied and the wheels properly chocked. If the seats are in an area of the apparatus that is occupied during driving, make sure they are either bolted down or otherwise secured so that they do not become a projectile in a crash.

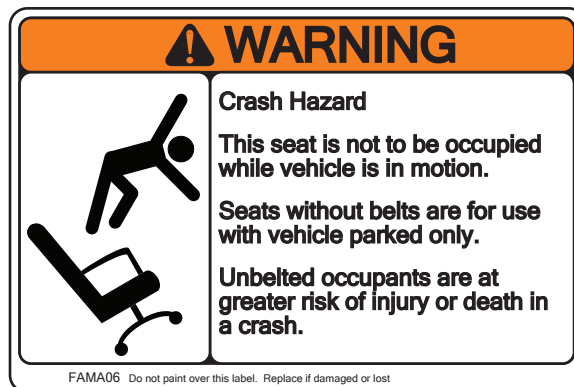

Swivel Seats

Your apparatus may be equipped with a seat that can be swiveled. The seat may be provided with multiple locking positions. Select the proper seating orientation before the vehicle is placed in motion and ensure that it is thoroughly engaged in the locked condition.

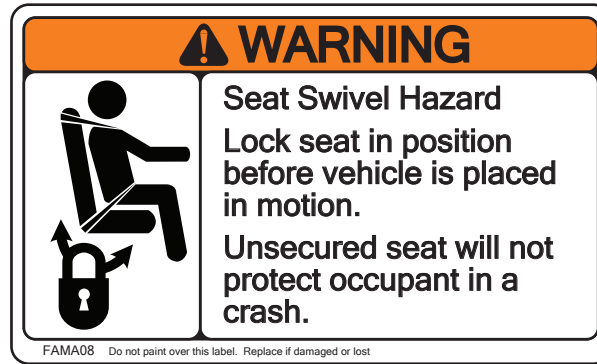

Air Bags

Your apparatus may be equipped with inflatable occupant restraints (air bags) that inflate if the apparatus rolls onto its side. Your apparatus may also be equipped with inflatable occupant restraints that inflate during a frontal crash. These air bags will only be effective in helping to protect you in a crash if you are also wearing your seat belt. Your seatbelt and associated safety devices will position you to allow the air bags to be effective in a crash.

If your apparatus is equipped with both air bags and suspension style seats, then the system will include a device for pulling the suspension seat down to its lowest position prior to the air bag inflating. This will happen in a split second.

If your apparatus is equipped with air bags, you must learn where they are, where they will deploy and what other devices will deploy in a crash.

Always follow these rules:

- Learn where each air bag on the vehicle will deploy.
- Do not place objects in the path of an air bag deployment.
- Do not cover seats with clothing or other items that will interfere with air bag deployment.
- Keep items and body parts away from the path of the suspension seat mechanism and seat belt tensioning devices.

Failure to follow these precautions may increase the risk of death or injury in a crash.

Helmets

Fire helmets are designed for a specific purpose and are not intended to provide protection in a crash. Wear your fire helmets when working around your apparatus, but do not wear it when your apparatus is in motion. Use approved helmet holders or other means of restraining your helmet in the event of a crash.



SCBA Storage

Your apparatus may be equipped with SCBA storage in the seat backs. Some SCBA storage devices must be adjusted to the specific SCBA bottle size or SCBA pack make or model. Make sure the bracket is adjusted properly and that any straps, buckles or latches are fully engaged so that the pack will not come loose during a crash. Leave your pack straps off or keep them loose while sitting in the seat as the bracket is not designed to take the weight of both you and your pack during a crash.

Before placing your apparatus in motion:

- Ensure SCBA bottles and packs are properly secured.
- Use seat back insert in seats where SCBA pack is not being stored.
- If wearing the SCBA harness, make sure it is loose.
- Place movable headrests in the closed position.
- Adjust SCBA holders for the SCBA pack make, model, and size.



SCBA Pack Buckles and Receivers

Your SCBA pack harnesses may be equipped with buckles and receivers that are similar to the buckles and receivers of your seat belts. Take care to ensure that you do not mistake one for the other. You will not be protected during a crash if the seat belt buckle is inserted into your SCBA pack receiver or vice versa.

DRIVE SAFELY

Controls Adjustment

It is important to keep your driving related controls properly adjusted for the person who will be driving. Make your adjustments at the start of your shift, and never make adjustment while driving. If you must readjust while driving, pull over when it is safe, stop the vehicle, place the transmission in neutral, apply the parking brake, and then make adjustments safely.

Adjust all controls prior to driving including the following:

- Steering wheel.
- Driver seat.
- Mirrors.
- Seat belt.
- Sun visor.

Driver Seat Adjustment

Adjust your driver seat at the start of your shift. Do not adjust seats with apparatus in motion. To obtain best ride quality, adjust suspension seats to the center of their vertical travel. Ensure proper reach to steering wheel and pedals.

Mirror Adjustment

Adjust seat before adjusting mirrors. Adjust your mirrors at the start of your shift. Adjust mirrors in a way that will optimize visibility to the sides and the rear. Using a partner, have them walk around the sides and the rear of the vehicle to determine where the blind spots are. Make sure any exterior view cameras are pointed properly and that their lenses are clean and unobstructed.

- Know your blind spots.
- Adjust seats and mirrors at the start of every shift or before driving.

Visibility Check

Ensure that you have excellent visibility using the following checklist:

- Windshield glass is clean.
- Cab side glass is clean.
- Mirrors are clean.
- Rear, side, or birds-eye cameras are clean and functioning.
- Windshield wipers function and blades are in a condition to wipe thoroughly.
- Washer fluid reservoir is full with commercial non-freezing washer fluid and washer sprayer is functioning.

SAFETY

Seat Belt Monitoring

Your apparatus includes a seat belt monitoring system that will alert you when an occupant is sitting in a seat but has not buckled their seat belt. Always check this monitor and do not release the parking brake until all occupants are seated and belted.

Know Your Tire Limitations

Fire apparatus axle weights are often higher than typical heavy trucks. Tire manufacturers recognize the need for fire apparatus to carry higher loads and that in most cases a fire apparatus does not travel at high speeds for long periods of time. Tire manufacturers will rate some of their tires with a special “fire service” intermittent duty rating. This allows the tire to carry greater loads or attain higher speeds as long as it does not have to do so for extended periods of time. To avoid tire degradation, fire service rated tires have limits on the amount of time they can be driven at high speed and high load before they must be allowed to cool down. Study your tire ratings, compare them to your in-service tire loads and know the speeds you can operate and any cool down periods that may be required.



FEMA Fire Tanker Guidelines

The US Fire Administration’s “Safe Operation of Fire Tankers” report is available as a pamphlet from **FEMA**, or it is available as a download from their website. Read this report completely, learn about the precautions and techniques it describes, and practice driving your fire tanker or tender safely. This report can be downloaded from the **FEMA** website at www.usfa.fema.gov.

Liquid Loads and High Center of Gravity

If your apparatus includes water, foam or other fluid tanks, you must take special precautions while driving. Liquid surge results from the movement of liquid in a partially full tank. There are two common times when liquid surge becomes a problem. The first is when you change directions, such as when negotiating a curve in the road. If you enter the curve too fast, centrifugal force will cause the liquid to surge against the wall of the tank and push your apparatus away from the turn. In severe situations, this surge can be sufficient to push you off the roadway or cause you to rollover.

Liquid surges will also affect your apparatus when stopping. During braking, the liquid surges toward the front of the tank. This additional force surging forward can further increase the stopping distance of your apparatus. After you come to a stop, the liquid in the tank will continue to slosh back and forth. On slippery road surfaces, this could cause your apparatus to be pushed forward into a hazard such as an intersection or a railroad crossing.

Whenever possible, do not drive with partial water loads. Keep the water tank full or empty when driving.

In addition to the hazard of a liquid load, your apparatus has a higher center of gravity (CG) than a passenger vehicle. A high CG makes your apparatus more likely to roll over in a turn. Never exceed the posted cautionary speed limit.

These combinations of factors mean that you need to slow down and be extra careful when making maneuvers such as:

- Lane changes.
- Curves at highway speeds.
- Tight radius turns.
- Downgrades leading into ramps.
- Curves on roads without a bank.
- Tight radius exits and off-ramps.
- Driving on any road with a cautionary speed limit posted.

Driving on Rough Roads

Your apparatus is primarily designed to operate on smooth paved surfaces. Driving on un-paved or poorly maintained roads will require you to slow down and proceed with caution. Your seating systems may not compensate for severe road conditions leading to injury. Slow down and use caution prior to encountering severe road conditions such as:

- Potholes, ruts or sinkholes.
- Speed bumps.
- Railroad crossings.
- Road construction.

Driving Off-Road

When you leave the public roads you must take extra precautions to ensure the safety of yourself, your vehicle, and those around you. It is likely that your apparatus has higher axle weights than typical off-road capable trucks and will be more susceptible to sinking into soft soil. A fluid load and higher center of gravity also require additional caution.

Know the capability of your apparatus and follow these guidelines:

- Always drive straight up or down a hill; never drive sideways on a hill.
- Get out and look. Walk the terrain before proceeding into unknown conditions.
- Check off-road conditions in your response area ahead of time so that you will know what to expect.
- Stay clear of excavations that are not properly shored up. Stay as far away from an excavation as it is deep (One to one ratio rule).
- Look for off-road hazards such as marshy areas, buried culverts, private bridges, animal dens, or other features that may not support your weight.

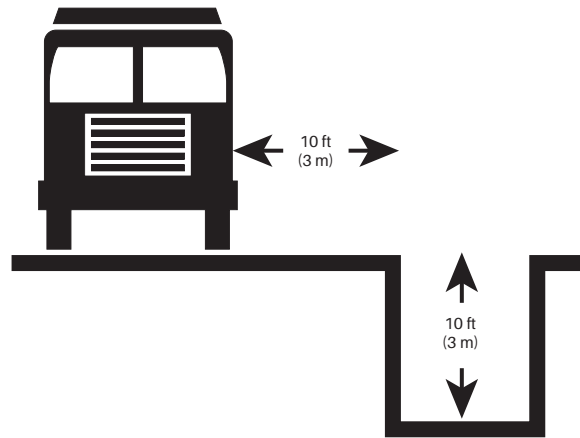

One-to-One Ratio Stay-Away Rule

No-Spin Axle Differential

Your apparatus may be equipped with a No-Spin differential or differential lock. With this feature engaged, use extreme caution when accelerating or decelerating on slippery or unstable surfaces. Vehicles equipped with traction or locking differentials are inherently more sensitive to side-slip.

Operate in low gear when coasting downhill into a turn. Braking capacity is reduced when a No-Spin or locking differential equipped vehicle makes a turn while coasting downhill.

Tire Chains

Never install tire chains on the steer tires. Installation of tire chains on the front tires may cause extensive damage to the cab as well as safety critical parts of the steering and brake systems. Damage to these components may lead to serious injury or death.

Water Fording

Your apparatus is not designed for operation in deep water. Your apparatus is capable of fording fresh stationary water at a depth not to exceed the center of the tire at slow speeds and for short distances only. Fording deeper water, at faster speeds, and for longer distances, can damage apparatus components leading to equipment failure, loss of apparatus capability, and expensive repairs. Never drive into flowing water like flash floods, rivers, creeks or streams. Flowing water has tremendous power and can sweep your apparatus away.

Components that will be affected by high water operation include:

1. **Engine air intake** - Water in the air intake will cause the engine to stop and may cause extensive damage.
2. **Drive Axles** - Breathers on the top side of drive axle housings can ingest water causing axle gear damage.
3. **Engine Fan** - Operating in high water can cause fan blade damage.
4. **Electronics** - Connectors, wiring, electronic modules, can be damaged or shorted out by submersion.
5. **Batteries** - Submersion of the apparatus batteries will kill the batteries and stall the engine.

Operation in salt water will cause damaging corrosion and lead to equipment failure.

Always know the depth of water before proceeding.

Heater Shut-Off Valve

Your apparatus may be equipped with a heater shut-off valve. This valve may have been specified by your department to ensure that there is no hot coolant supplied to the cab heater core during hot seasons of the year. Use this valve with caution and make sure it is open whenever needed. Use of the heater shut-off valve will prevent warm air from circulating through the defroster system and may lead to a reduced ability to clear humidity from the windshield and subsequent reduced driver visibility.

STOP SAFELY

Brake System Pressure

Your apparatus braking system relies on air pressure created by a pump that runs off the apparatus engine. Do not release the parking brake and move the vehicle until the front and rear air gauges indicate at least 60 psi in both circuits. 100 psi is preferred for maximum stopping capability.

Anti-Lock Brake Systems

Your apparatus is equipped with an anti-lock braking system (ABS). ABS monitors the rotation of the wheels and pulses the brakes when it senses a skid. This can help you maintain control during a stop. ABS can greatly increase the control you have when stopping on wet or slippery surfaces, but it cannot provide more braking performance than the road conditions will permit. Your apparatus is big and heavy and should always be operated with caution knowing that it takes a lot of energy to bring it to a stop.

Maintaining Control

- Do not pump brakes on vehicles equipped with ABS. Anti-lock type brakes pulsate to prevent lock-up. Pumping brakes defeats the anti-lock function.
- Hold the steering wheel with both hands on opposite sides of the wheel.
- Always look 12 to 15 seconds ahead of where you are driving.
- Ensure adequate distance between the vehicle you are driving and the vehicle ahead. Braking distances can double when the vehicle is loaded.

New Brake Lining Performance

If your apparatus has had its brake linings replaced, they will need to be broken in before they will perform as well as the old linings did. Brake linings need to be “burnished” after installation. This is the process of wearing the high spots off the linings so that they grab over their entire surface. Be alert to any service work on your apparatus involving brake lining replacement and adjust your driving accordingly. The vehicle’s stopping distance and the capability of the vehicle to hold on a specific grade may decrease temporarily whenever new brake lining material is installed.

Quick Build-Up Air Brake Pressure System

Your apparatus may include a quick build-up air brake feature as required by **NFPA® 1900 Standard for Aircraft Rescue and Firefighting Vehicles, Automotive Fire apparatus, Wildland Fire Apparatus, and Automotive Ambulances**. The quick build-up feature allows the vehicle to be driven even though the front air brake reservoir may not have sufficient air pressure to enable sustained or full force braking.

SAFETY

While this is a requirement of the NFPA standard, it is not recommended ever beginning to drive your apparatus without the air reservoirs fully charged. If you chose to make use of the quick build-up feature you must drive slowly and cautiously until your brake reservoirs are charged to above 60 psi.

You can reduce the risk of leaving on a call with low air pressure by always connecting the air brake system to an external air supply whenever it is in the station.

Auxiliary Braking Systems

If your apparatus is over 36,000 lbs. GVW, it will be equipped with one of the following auxiliary brake systems:

- Allison transmission retarder.
- Telma electromagnetic retarder.
- Jake Brake.
- OEM Engine Compression brake.
- OEM Exhaust brake.

All of these systems apply braking force through the drive wheels only.

During slippery road conditions or inclement weather, an auxiliary braking system may cause rear wheel lock-up and loss of vehicle control. Turn your auxiliary braking system(s) off before encountering slippery conditions.

If you forget or fail to turn off your auxiliary brake in slippery conditions and begin to lose control, apply the service brakes and make a safe stop. If the ABS senses a loss of braking control it will disengage the auxiliary brake and initiate an ABS event, helping you maintain control.

Descending Steep Grades

You should use a combination of service brake application, transmission down-shifting, and auxiliary braking when descending a steep grade. Anticipate steep grades and downshift before you begin to descend. Downshifting to a lower transmission range increases engine braking and helps you to maintain control. Apply the vehicle brakes or other retarding device to prevent exceeding engine governed speed in the lower range selected. Service brakes can overheat and lose effectiveness if used too much. To help avoid loss of control, use a combination of downshifting, braking, and other retarding devices.

Electronic Stability Control

Your apparatus may be equipped with an Electronic Stability Control (ESC) system. This system knows which direction you are pointing the wheel and pumps the brakes appropriately to help point the apparatus in the direction that you are turning. This system is most effective on slippery surfaces.

ESC cannot prevent accidents or loss of control of the vehicle. You can still exceed the physical limitations of the system with either excess speed or extreme cornering, causing a loss of directional control or rollover.



Parking Brakes and Wheel Chocks

Your apparatus has a parking brake knob that must be engaged any time you leave the driver's seat. You must always place the transmission in Neutral (N) and then engage the Park Brake. As soon as you leave the cab, you must chock the wheels. Wheel chocks will help keep your apparatus from rolling in the event that the parking brakes malfunction or are released unintentionally.

Auxiliary Front Wheel Lock

Your apparatus may be equipped with an auxiliary front wheel lock system. The auxiliary front wheel lock feature uses air brake system pressure to keep the front brakes applied while parked. This system uses air pressure (rather than a passive spring) to keep the front brakes engaged and should only be used with the engine running and a qualified attendant present at all times. This feature is meant to enhance the parking performance of the vehicle, but it does not take the place of the spring brakes or the act of chocking the wheels. Always use wheel chocks.

Backing Your Apparatus

According to the National Safety Council, one out of four vehicle accidents can be blamed on poor backing techniques. Avoid backing hazards by planning ahead and avoid situations where you will need to back up:

- Choose pull-through parking spaces.
- If parking in an alley, back into it so that you are pulling forward onto the street when you leave.

Before backing:

- Get to know your vehicle's blind spots. In a typical truck, blind spots can extend up to 16 ft. (4.87 m) in front of and 160 ft. (48.76 m) behind a vehicle. Use a helper who can walk around your vehicle while it is parked to get to know when you can and cannot see them. Remember, mirrors can never give the whole picture while backing.
- Check for people, children or obstructions in the area.
- Check for soft soil, potholes, tire hazards, low hanging trees, powerlines or other dangers.
- Agree with your spotter that they will use hand signals and make sure your both understand their meaning.
- Equip spotter with reflective vest or other reflective gear.

SAFETY

- If backing at night, provide spotter with illuminated wands.

While backing:

- Use a spotter to assist.
- Don't allow your spotter to walk backwards while giving instructions.
- Keep your spotter in your mirror and don't let them stand in the path of your apparatus.
- Place your transmission in reverse and listen for the back-up alarm before taking your foot off the brake.



PARKING SAFELY

Parking On a Grade

Park on level ground whenever possible. Never park on a steep grade (a grade that is more than 20 percent). A 20 percent grade means that the ground rises one foot vertically for every 20 ft. (6.10 m) of horizontal distance. Your apparatus is not designed to park safely on any grade that is steeper than 20 percent.

When parking on any grade, set the parking brake and then remove your foot from the service brake pedal slowly. Observe the ground to make sure your apparatus is not moving. If your apparatus moves, relocate your apparatus to a more level location. Chock your wheels immediately upon exiting.

Park Away From Fire

When positioning your apparatus at a fire scene, be aware of where the fire is and where it is likely to spread. Park up-wind from the fire and in an area where the apparatus will be protected from direct heat and flames. High heat will melt lights, damage paint and, in extreme cases, catch the apparatus on fire.

Burning embers in the engine air filter can start the engine and vehicle on fire. Your apparatus is equipped with an ember screen to reduce the likelihood of burning embers catching the air cleaner media on fire, but it is not a guarantee. Determine where the air intake opening is located on your apparatus and avoid running the engine in an ember rich environment to minimize any possibility of catching the rig on fire.

Park Away From Fuel Vapors

Your apparatus is powered by a diesel engine. A diesel engine does not require a spark for ignition and will continue to run as long as there is fuel available. If you run your engine in an atmosphere that is laden with fuel vapors, such as at a fuel spill or gas leak, the engine may increase speed uncontrollably. If turning the ignition switch or battery switch OFF does not cause the engine to stop running it may be in a runaway situation. The only way to stop the engine in this situation is to eliminate the fuel source. Engage the emergency engine stop (if so equipped), eliminate the source of the fuel vapors, or cover the engine air intake to starve the engine of air and vapor.

Leaving Apparatus Unattended

Never leave your apparatus unattended. If your apparatus includes an aerial device, stow the aerial and retract the stabilizers. Park the apparatus in a secured location, and take other precautions as necessary to ensure that unauthorized personnel are prohibited from operating it.

Park Away From Power Lines

Look up and live. Always check the area and identify power lines before positioning your apparatus. Make sure you are well clear of power lines before raising equipment such as aerial devices or light masts. Never climb onto the apparatus if it will bring you closer than 20 ft. (6.10 m) from an overhead wire. Overhead power lines are not insulated. Some lines have a weather covering and appear to be insulated; they are not.

You or your apparatus do not need to touch a power line to be energized. Electricity arcs across ionized paths of air when a conductor is close enough. Consider all overhead wires or cables to be hazardous and dangerous. Never touch the outside of a vehicle you suspect may be energized while you are standing on the ground. Electricity will flow from the vehicle through you and into the ground. Move away from the vehicle and stay away. Warn others to stay away.

Unless the vehicle is on fire, it is safer to stay in the charged vehicle than to attempt to exit. If it is necessary to exit the vehicle, jump as far away as possible while landing with both feet together. Maintain your balance. Fall forward and away from, rather than backward and towards the vehicle. Once clear of the vehicle, don't return until a power company representative confirms that it is safe and that the line has been de-energized and grounded. Do not attempt to rescue a person in or on a charged vehicle.

- Look up and live.
- Stay in or on a charged vehicle.
- Stay away from vehicles charged by power lines.
- Keep vehicle, people and equipment away from power lines.

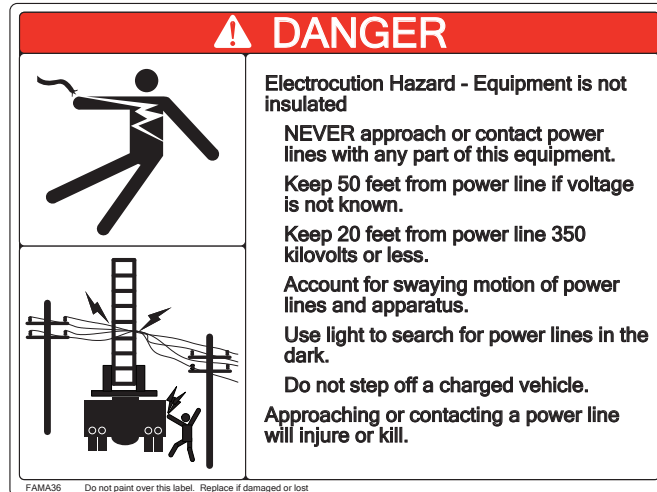

Idle Mitigation

Your apparatus may be equipped with idle mitigation technology to improve fuel economy and reduce the carbon footprint of the apparatus. This system shuts the main chassis engine off and then starts it again when the idle mitigation batteries require recharging. When the engine starts, the fan, belts, and other components will spin. Keep hands, clothes and other body parts clear of all powertrain components. Never crawl or work beneath your apparatus or work near your apparatus powertrain unless the ignition switch and the battery switch are both in the OFF position. Use lock-out tag-out procedures before servicing or maintaining.

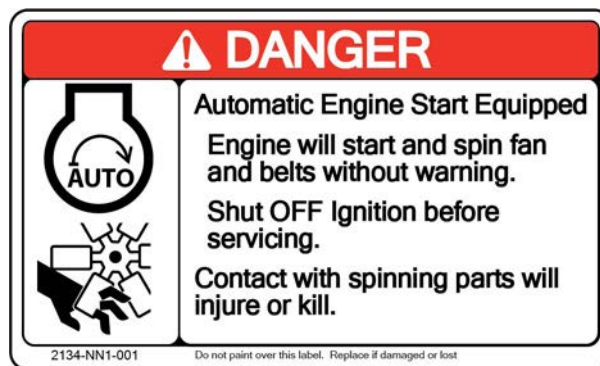

Winch and Rope Anchors

Your apparatus may be equipped with a hitch receiver or other device intended to anchor a portable winch or to be a tie-off point for rope operations. Pulling in a direction other than a straight line away from these anchors must be done with extreme caution. Your anchor is designed for maximum pull in a straight line away from the apparatus only. Align your apparatus with the pull or the capacity of the anchor will be significantly reduced and you risk an anchor failure.

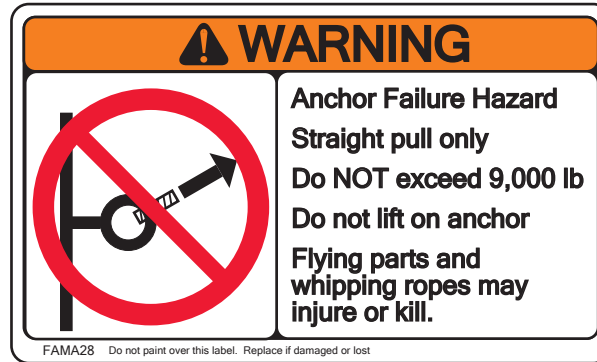

FUEL SAFELY

Before fueling, turn off the engine. Put your apparatus in neutral, set the parking brake, turn off the ignition switch, and chock the wheels.

Use only ultra-low sulfur diesel fuel (15 ppm sulfur).

Disable or turn off any auxiliary sources of ignition such as on-board fuel operated line voltage generators or fuel-fired heaters.

Do not smoke, light matches or lighters while refueling.

Use only the refueling latch provided on the dispenser nozzle.

Stay at the nozzle until the tank is full.

Never blend gasoline, gasohol and/or alcohol with diesel fuel. This practice creates an extreme fire hazard and under certain conditions an explosive hazard.

Check and fill the DEF tank with DEF if required.

Never add DEF to the Diesel fuel tank, and never add Diesel fuel to the DEF tank. In either case severe engine and/or emissions system damage will occur.

BEFORE PLACING YOUR APPARATUS IN-SERVICE

No truck should be placed into service if there is any doubt or evidence of improper or inadequate function of any of the components or systems.

Install Electronic Equipment Properly

Do not add electrical devices to your apparatus unless they are installed by qualified service technicians who understand how to provide proper circuit protection. Always replace fuses or circuit breakers with the correct size. Improper fuse or circuit breaker sizing can cause wires to overheat and burn.

Do Not Install Equipment in Air Bag Path.

If your apparatus includes Inflatable Occupant Restraints, determine where each of the air bags is located, and where their deployment path will be. Never mount equipment in the path of an air bag. This includes the following areas.

- The outboard area between a seat and the side of the cab.

SAFETY

- Between the front passenger seat and the dash (officer knee area).
- Between the driver seat and the dash (driver knee area).
- Under any seat suspension.
- On the steering wheel.

Install Front Bumper Mounted Equipment Properly

Avoid mounting equipment in a manner that blocks airflow to the grill. Large items blocking air to the grill may degrade cooling performance and cause the engine to overheat during heavy use and high ambient temperatures.

When mounting equipment to the bumper deck plate of a tilt cab, consider the motion of the cab when tilting to avoid interference in the tilted condition.

When mounting equipment to the bumper deck plate, do not block headlights, warning lights or flashers, turn signals, and side markers. Blocking any of the above can put the apparatus and personnel in danger of a collision that may cause injury and/or death.

Install Cab Interior Equipment Properly

Consider the effect of cab tilt on equipment storage to avoid damage from items falling forward when the cab is tilted for service or maintenance.

Monitor the weight of items installed in a tilt cab, or stored in tilt cab storage areas. Too much weight inside the cab may prevent the cab from being tilted for service or maintenance.

Refer to **NFPA** guidelines when mounting equipment inside the cab to avoid unnecessary risk of injury from flying objects during a collision.

Use caution if drilling into cab walls and headliners to mount equipment, as there may be wiring, heater hoses, or air conditioning hoses hidden beneath the surface.

Never mount any equipment in the deployment path of an air bag, seat belt pretensioner, or suspension seat pull-down device.

Install Air Pressure Operated Equipment Properly

Any air-operated equipment must only be added to the air system downstream of a pressure protection valve.

Consider the airflow requirements of any air-operated accessory that will draw pressure from the vehicle system. The engine air compressor output is but a fraction of its total capacity at engine idle and will not keep up with the continuous operation of most shop type air tools.

Pressure protection valves are installed in both front and rear brake systems to ensure that no other air pressure requirements of the vehicle are allowed to deplete the vehicle braking system capabilities.

Addition of any air pressure equipment added by the end user up-stream of these pressure protection valves will negate the conformance of the vehicle to this **NFPA** recommendation and property damage, personal injury and/or death could result.

Consider Dissimilar Metals When Mounting Equipment

Consider the metal types whenever mounting accessories. Dissimilar metals placed in direct contact with each other and subjected to moisture will form a galvanic reaction that will lead to rapid corrosion and possible failure of the mount, fastener, or base material. Select mounting material and fasteners to avoid dissimilar metals, or coat all mounting surfaces, base material, and fasteners with a commercial grade-rust proofing agent such as those conforming to MILC-0083933A specification.

Load your Apparatus Properly

Before placing the apparatus in service, load all compartments with the intended equipment and manpower. Top off all fluid tanks and obtain front and rear axle weights from a certified scale. Compare the results to the axle capacities listed on the Federal Motor Vehicle Safety Standard (FMVSS) information decal located inside the cab. In service weights must not exceed the axle capacities listed on the tag. If the scale weights are higher than the gross axle weight rating (GAWR) values listed on the label, move or remove equipment and re-weigh the apparatus until you are within the axle's limits.

Once you have each axle within its GAWR limits, obtain individual wheel weights and be sure you are within 7% weight difference from side to side.

Establish a routine of repeating the axle weight review at least annually to ensure that changes in equipment storage or other variables have not increase the axle loading beyond their placarded capacity.

Establish Correct Tire Pressure Values

Use the in-service axle weights to determine the correct tire pressure values using the latest information from your tire manufacturer (available on-line). Each tire manufacturer provides charts that will tell you the proper tire pressure for the load that the tire is carrying. Be sure to use the correct data based on your specific tire make, model, and size. Record the correct tire pressure settings on your vehicle inspection checklist. Adjust your tire pressure to match these values.

NOTICE

The tire pressure indicated on the FMVSS label located in your apparatus cab will be based on loading your tires to the Gross Axle Weight Rating (GAWR). If your apparatus in-service axle weight is less than the GAWR, then you should decrease the tire pressure to the correct value based on your in-service load. Failing to do so will reduce handling performance and lead to a rougher ride.

Leaf Spring Suspensions With U-Bolts

Your apparatus may be equipped with a leaf spring suspension at the front, the rear, or both. Leaf springs can settle during the initial run-in process, dropping by as much as 0.50 in. (12.7 mm) U-bolts must be tightened to their proper torque after the first 500 miles (804.672 km) of apparatus driving, or 500 miles (804.672 km) after a spring has been replaced.

SAFETY

Safety Equipment

Ensure that all of the safety equipment required by **NFPA**, your department policy, and applicable regulations are on the apparatus or available including:

- Personal Protective Ensembles.
- Fall Protection Belts, Tethers, or Harnesses.
- Wheel Chocks.
- Traffic Cones or Flares.
- Fire Extinguishers.
- Safety Vests.
- AEDs.

Demonstration and Training

Factory or dealer demonstration may be provided to familiarize you or a department with the apparatus. Training is the responsibility of the department and should include instruction, experience, and skills testing. All personnel that will operate the apparatus should have completed department authorized training in accordance with **NFPA 1451** *Standard for a Fire and Emergency Service Vehicle Operations Training Program*.

PUMPER SAFETY

Storing, Deploying and Retrieving Hose Safely

Your apparatus may be equipped with hose storage areas. There are hazards related to stowing and laying hose and you must develop safe procedures for doing both.

Your department may choose to drive your apparatus during the hose laying or stowing procedure. This must be done with extreme caution and under the supervision of fire department authorities. Your apparatus is designed to transport personnel while seated and belted in the cab only. Any procedure that involves personnel riding on the apparatus, working around a moving apparatus or handling hose that is being dropped off a moving apparatus, involves risks that your apparatus was not designed to avoid. Understand these risks and develop your safety procedures accordingly. Your procedure should address the following risks:

Snags and Snarls

Hose storage areas may have structural features or components that can snag hose while it is being pulled out. Such features may include hose chutes, hose bed cover supports, emergency lighting, access steps, hand rails, pre-connect piping, etc. You will need to develop hose packing and deploying methods that will reduce the possibility of snags.

Pack hose carefully in any hose storage area to minimize the risk of hose or connections snagging or snarling during deployment. Hose that snags or snarls during deployment from a moving vehicle can whip violently, causing death or injury.

Slips and Falls

Develop hose practices that will protect yourself and others from slips and falls. This may include the use of auxiliary ladders, scaffolding, safety harnesses or other methods while stowing hose in areas that are high up on your apparatus.

Driving while Deploying

If you choose to drive your apparatus to deploy hose, never drive faster than you have determined to be safe, and definitely never faster than 5 mph (8 kph). Your apparatus is very heavy and powerful. It will not be stopped by a hose. If the end of the hose is held firmly to a hydrant or other object and the deploying hose catches on part of the apparatus, the hose in between will whip violently and forcefully causing damage, injury or death.

Do not stand on or near hose and hose couplings when vehicle is moving. Never wrap hose around you or others while deploying. Serious injury may result.

Driving while Retrieving

Do not reload hose by backing the vehicle up while personnel are walking behind the vehicle. This is an extremely hazardous practice. Drive forward over the top of the hose so that you can always see where you are driving. Stop after each section has passed the rear bumper, place the transmission in neutral, and apply the parking brake. Only when you are sure the vehicle is stopped and the parking brakes are set should you signal that it is safe for personnel to approach the apparatus and load the section of hose that is now behind the vehicle. When that section has been loaded, clear the area and drive forward over the next section. Repeat this process until all the hose has been loaded.

Consider other methods such as using hose rolling devices that make it easy to roll each section of hose and wheel it by hand to the parked apparatus. Whatever method you choose, always place the safety of your crew ahead of time or efficiency considerations.



SAFETY

Hose Bed Covers

Your apparatus may be equipped with solid hose bed covers. These covers are heavy and will be affected by strong winds and the grade the vehicle is parked on. The vehicle should be parked on level ground when the cover is lifted. Do not lift the cover in strong winds. Use two people to lift the cover. Make sure the cover restraining devices are in place and secured before releasing the hold of the cover. Make sure personnel have a secure hold of the cover when releasing the restraint device. Failure to follow these instructions could result in serious injury.

USING HOSE SAFELY

Hose on the Fire Scene

If your apparatus is equipped with a pump it can produce very high water pressure. Fire hose under pressure can burst without warning. Use only tested hose with your apparatus and never straddle or stand over a charged hose. Hose fittings can fail without warning. Inspect hose fittings for cracks, chips or other damage and replace when worn or damaged. An uncontrolled hose discharging foam or water will whip violently. Never pressurize a hose unless the discharge nozzle is closed and the nozzle is held or secured firmly.

Testing Hose

Your apparatus was never designed to be a hose testing device. While **NFPA® 1962** *Care, Use, Inspection, Service Testing and Replacement of Fire Hose, Couplings, Nozzles, and Fire Hose Appliances* does include a procedure for using a stationary pump or apparatus for hose testing, we recommend employing a proper hose testing machine as a much safer alternative. Hose test machines can develop the required test pressure at very low power levels. Since the whole point of hose testing is the assumption that your hose has seen service that might render it incapable of standing up to the test pressure, it is much more prudent to perform hose tests with the proper equipment. **WE CANNOT BE RESPONSIBLE FOR INJURY IF YOU DECIDE TO USE YOUR APPARATUS TO TEST HOSE AS YOUR APPARATUS WAS NOT DESIGNED TO DO SO SAFELY.**

DISCHARGE WATER SAFELY

Your water pump is a powerful machine which can hurl many tons of water every minute. This type of power can do great good in suppressing fire, but it can do great damage if not handled properly. Always treat pressurized hose and piping with the greatest respect and be thoroughly trained on safe pumping procedures before operating your pump. Be sure to avoid the following potential hazards:

Water Stream

You should use water streams for fire suppression only. Never direct your water stream at a person. Never open a discharge valve where the stream could strike a person. Water streams may knock people to the ground, causing injury or death.

Power Lines and Fire Suppression

Water is a conductor of electricity. Recognize the ability of water to conduct electricity. Never spray water around high voltage electrical wires. Electricity can travel down a water stream. Never spray water or foam through or onto live electric wires.

Boiling Discharge Water

It is essential that you always keep your pump water cool. This means that you must always circulate cool water through the pump. Your apparatus may include a recirculation valve that must be opened, or your apparatus may require the tank-to pump valve be open and the tank-fill valve to be opened slightly. You must know how your pump works and the necessary steps to keep the water cool. A pump without a constant supply of cool water flowing through it can quickly overheat the water. Hot water and steam may cause severe burns if overheated water is discharged on you or another person.

Matching Equipment to Pump Pressure

Your apparatus was manufactured with fittings, valves and piping connections as specified by your department. You must be sure that fittings, valves, connections, hoses and nozzles that you use with your apparatus are compatible, tested and capable of the flow rates and pressures that you will be using them with. Hoses, valves and fittings can explode if pressure capacity is exceeded. Never exceed the working pressure of downstream devices.

Pump Operation

Your pumping apparatus will power the pump using either the main truck driveline, a power-take-off from the engine or transmission, or a separate dedicated engine. You must study and learn how to properly engage, disengage and operate the pump on your apparatus. As a custom apparatus, every pump control layout may be different as specified by your department. The operation of your pump was demonstrated by your apparatus dealer at the time of delivery to members of your department who are responsible for training you in proper operation. Also study the *IFSTA Pumping and Aerial Apparatus Driver/Operator Handbook* to learn critical information on proper pumping procedures.

Emergency Pump Procedures With Failed Engine Control

Your apparatus may control pump pressure with a manual engine control and a relief valve or with a pressure governor. In either case, you should learn what to do if your primary pump control fails. Many apparatus can continue to pump after a control system failure by stationing an operator in the driver's seat and having them control engine speed with the foot accelerator. This procedure can be used in an emergency, but the firefighters on the lines should be immediately recalled from imminent danger, and the apparatus should be replaced on the fire scene as soon as possible. Take great care to keep a steady foot on the pedal to avoid sudden fluctuations in pressure.

Pressure Fluctuations

Sudden changes in water pressure are hazardous to firefighters at the end of a hose. Rapidly fluctuating pressure in a fire hose can cause the hose to whip. You must learn to avoid the many causes of pressure fluctuation including:

- Turning off a pressure governor.
- Sudden adjustments to engine speed.
- Opening or closing valves too quickly.
- Failing to remove air from pipes and hoses.

Always bleed the air from the intake lines before opening the intake valve at the apparatus. Stay alert for fluctuations in hose pressure and react quickly and safely when they do occur.

Intake and Discharge Caps

Your pumping apparatus may be equipped with either threaded or Storz-type couplings. In either case, you must avoid the hazard of removing intake or discharge caps that have pressure behind them. Intake and discharge caps can trap pressure if the valve controlling the connection is opened and then closed again when there is pressure in the system. This pressure can remain trapped between the cap and the valve for a long time. Always open the drain or bleeder valves first to relieve any pressure that may be trapped behind the cap before attempting to remove it. Open caps slowly and never stand in front of a cap during its removal. If you open a cap with pressure behind it, the cap may blow out at you with extreme force. You or others may be injured or killed.

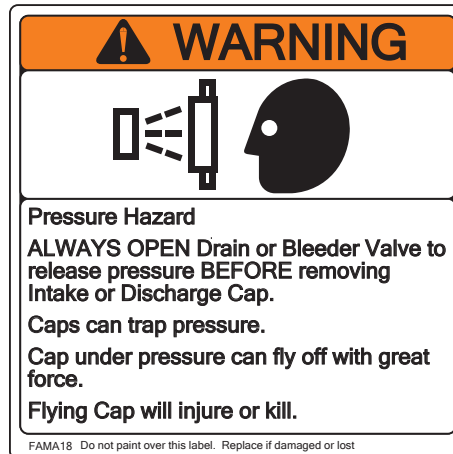

Pump and Roll

Your apparatus may be designed to Pump and Roll. This means that you can discharge water while the apparatus is moving. This may be beneficial for fighting grass or wildland fires. While the apparatus may have this capability, you must take particular care if you use this capability.

Remember that your apparatus is designed to transport personnel only if they are seated and belted. You should only discharge water from a moving apparatus by using a method approved by the National Fire Protection Association. If you choose to move the apparatus with firefighters using charged lines walking with the apparatus, use the following precautions:

- Drive at slow speeds only.
- Always stay clear of a backing vehicle.
- Never walk in front of a moving vehicle.
- Keep walking personnel alongside the apparatus and in view of the driver at all times.
- Keep walking personnel far enough from the apparatus so that they won't be crushed if the apparatus were to roll onto its side.
- Develop and practice procedures to get walking firefighters quickly into the apparatus and belted into a seat in the event that the fire shifts, and you need to retreat from the area.

High Pressure Two-Stage Pump

Your apparatus may be equipped with a two-stage high pressure pump. A two stage pump can be operated in the VOLUME mode at typical municipal fire suppression pressures of 80 to 120 psi (551 to 827 kPa). In the PRESSURE mode, this same pump can discharge at pressures up to 600 psi (4136 kPa), useful for charging standpipes in high rise structures. Normal fire suppression hose, nozzles, wyes, and other appliances are not likely to be rated for these high pressures. Train your personnel to use only specially rated high pressure hose and components when operating in the PRESSURE mode.

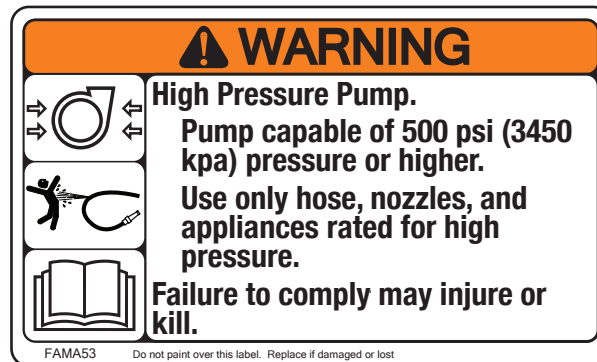

Ultra-High Pressure Water Stream

Your apparatus may be equipped with Ultra High Pressure (UHP) streams of water or foam solution to fight fires. UHP presents unique hazards and should be used only by trained, safety-conscious personnel. UHP water or foam solution is discharged at pressures over 1,000 psi (6894 kPa). At this pressure, the discharge stream may be capable of puncturing human skin, thus entering the blood stream. Personal protective equipment (PPE) such as gloves, turn-out gear, boots and a mask with a face shield should be worn whenever using UHP.

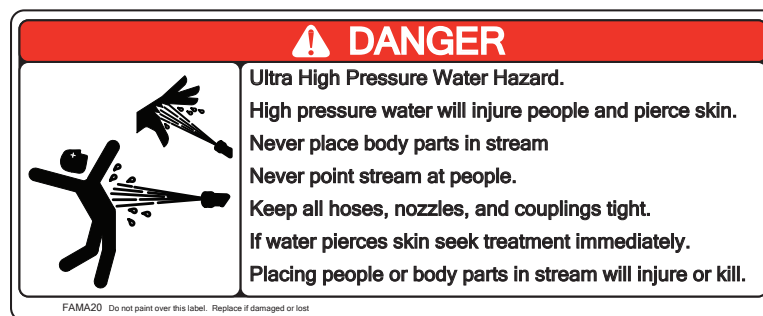

Tighten all fluid connections before operating this equipment and check the hoses, nozzles, and couplings after every use. A leak in a high pressure line can inject fluid into human skin just as it can from the nozzle. Never search for leaks with your hands or other body parts. Use a piece of wood or cardboard to detect leaks, keeping hands and other body parts well away from the potential source of the leak. Replace worn, damaged or loose parts immediately.

Ultra-High Pressure Piercing Equipment

Your apparatus may be equipped with an ultra-high pressure device used for piercing structural material. These devices use an aggregate added to the water stream that will cut through solid objects. It will also cut through skin and bones. Use safety precautions and treat a UHP piercing device with all the respect you would use with a firearm.

SAFETY

Foam Concentrate Types

If your apparatus is equipped with a foam system, you should know and understand the type of foam solution that it's capable of using. Never mix brands or types of foam concentrate, or the foam produced may not be adequate for the fire suppression capability desired.



Water Monitor

Your apparatus may include a water monitor on the front bumper, cab roof, apparatus top, or other location. You may also choose to use a ground monitor when pumping. Following these practices when discharging water from a monitor:

- Charge your monitor slowly. Rapid charging may cause a pressure surge which has the potential to cause an injury, or damage the monitor.
- Aim your monitor in a safe direction before discharging water.
- Never direct the stream at power lines or people.
- If there is a nozzle attached, ensure that it is tight and not over tightened before using the monitor. Do not use with a loose nozzle. A loose nozzle is a dangerous projectile. Ensure the thread on the nozzle swivel matches the thread on the monitor outlet. Do not over tighten the nozzle onto the unit.
- Read and follow the warning tag instructions on the lock pin lanyard.
- Do not exceed the maximum pressure or flow ratings of the monitor. Exceeding these ratings may lead to an injury or may cause damage to the monitor.
- If not equipped with the automatic drain valve, drain the monitor after use to prevent freeze damage.

Ground Water Monitor

In addition to the above instructions, a ground monitor (water monitor not attached to your apparatus), must be properly secure staked down or otherwise secured before use. Water discharge force will cause a loose monitor to fly about with great force causing injury or death.

AERIAL SAFETY

Your aerial device is a very complex machine that requires specific knowledge, training and experience to operate safely. You must study and learn how to properly set up and operate your aerial device. Study this manual and the *IFSTA Pumping and Aerial Apparatus Driver/Operator Handbook* to learn the proper procedures.

Emergency Stop Feature

Your aerial device will have an emergency stop (E-Stop) feature at the primary operator station controls. This may be a switch on the panel, or an operator present foot pedal. This is a very important safety feature on the aerial. If something goes wrong and the aerial is behaving in a manner you don't understand, use the emergency stop feature to stop all aerial functions.

Once aerial functions have ceased, clear personnel from the area and determine what is wrong before resetting the emergency stop feature and continuing operation. Practice using the emergency stop feature during training sessions until it becomes second nature so that your mind will react quickly in an emergency.

Emergency Power Unit

Your aerial device uses power supplied by a hydraulic pump that is driven by a power take-off from the engine. It is always possible that a mechanical, electrical or hydraulic failure can occur that will interfere with the operation of your aerial device. The Emergency Power Unit (EPU) will provide back-up power and, in most cases, allow you to continue operation until you can recall personnel from harm's way, stow the device and remove it from the fire scene for repair. Do not rely on the EPU for extended use as it is not designed for continuous operation.

Over-Ride Controls

Your aerial device has certain over-ride features that will allow "out of the ordinary" operation in certain cases of equipment malfunction. You should learn where these controls are located and how to operate them. Practice using your override controls until you are just as proficient with them as you are with the standard controls.

If the normal control system does malfunction, recall personnel from harm's way immediately and take the device out of service until it can be repaired. Use emergency override controls with extreme caution and only when all non-essential personnel are well clear of any hazard.

Interlocks

Your aerial apparatus will be equipped with a number of interlock functions, many of which are required by **NFPA® 1900 Standard for Aircraft Rescue and Firefighting Vehicles, Automotive Fire apparatus, Wildland Fire Apparatus, and Automotive Ambulances**. Interlock devices are intended to reduce the possibility of unsafe actions, but they should never take the place of careful, thoughtful and prudent operation. Interlocks rely on the proper functioning of sensors, wiring, relays and computers. These are physical components that have finite lives and can fail from a number of causes such as wear, corrosion, accidental damage or aging. You should identify each interlock and develop a procedure on how to safely ensure that each is functioning.

Aerial device interlocks may include:

1. **Stabilizers Set:** The aerial device will not operate unless the stabilizers are deployed.
2. **Nozzle Stow:** Device will not drop into the cradle if the master stream nozzle is not properly positioned.
3. **Body Collision:** The device will not move into regions where it would make contact with the body or cab.

SAFETY

4. **Maximum Elevation Slow-Down:** The device will slow down prior to reaching maximum elevation or extension.
5. **Rotation Interlock (Short-Jack):** The aerial device will not rotate over the side of the apparatus where the stabilizers are not sufficiently extended.
6. **Tiller Operator Interlock:** Engine starter will not work unless the tiller operator is seated and belted, or a tiller cab start button is engaged.
7. **Aerial Function Interlocks:** The aerial device will not operate until the parking brakes have been set, and the transmission has been placed in neutral, or the transmission is in the drive position with the fire pump engaged.

PREPARE FOR SAFE AERIAL OPERATION

Select a Site

Selecting the right spot to position your aerial apparatus is critical. You must anticipate fire ground needs and identify areas where to position so that the aerial tip can reach your intended targets. Select a position that will support your apparatus weight and meet all of the following criteria:

- Clear of areas exposed to falling debris.
- Clear of overhead power lines.
- Flat enough to allow leveling within the green or yellow zone.
- Firm and stable surface. Avoid loose objects, underground utility access covers, broken pavement and areas that drop off suddenly.
- Never position on a railroad track or an active airport runway.

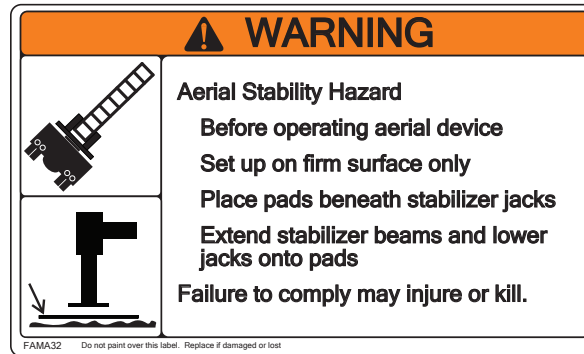

Set-Up

Once you have selected a set-up location, clear the area of personnel and use spotters to maneuver your apparatus into position. Follow the instructions in this manual to place your apparatus in operation ensuring the following:

- Use auxiliary stabilizer pads (If Equipped).
- Keep the stabilizers in your sight at all times while deploying. Use spotters if needed.

Setting Up Within Safe Limits

Your aerial device must be within a few degrees of being level for safe operation. Check your level indicators to make sure that the device is properly leveled. The correct angle reading is where the center of the ball lines up with the gradation lines marked on the tube.

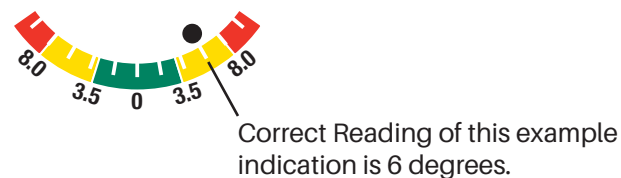

Figure 4-1. Level indication of 6 degrees

SAFETY

You can still operate safely even if your device is not perfectly level, but only if you keep it within the safe limits as indicated on the load chart for either the green or yellow zone. Do not operate with either the front-to-back or side-to-side level indicators in the red zone.

Table 4-2: Working Zone

Level Indicator Reading		Working Zone
Front-to-Back	Side-to-Side	
Green	Green	Green
Green	Yellow	Yellow
Yellow	Green	Yellow
Yellow	Yellow	Yellow
Yellow	Red	Red
Red	Yellow	Red
Green	Red	Red
Red	Green	Red
Red	Red	Red

Avoid operating your ladder in a condition where the ladder rungs are not level to the earth as this will make climbing more difficult.

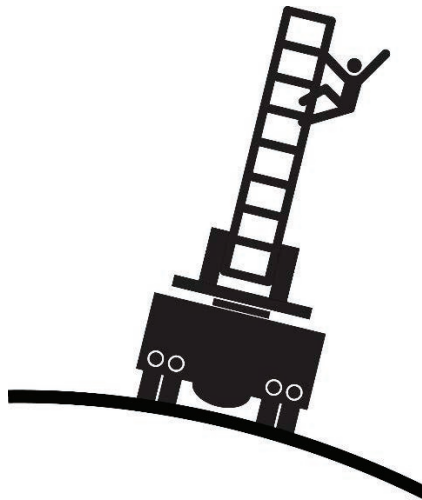

Short-Jacking

Your apparatus may allow for partial extension of the stabilizer beams. Partial extension may result in no operation on that side of the apparatus. (A short set condition.) Apparatus equipped with the Multi-Stance™ system may allow for reduced loads on the ladder. This capability allows your apparatus to be set up in an area where obstructions or surface conditions do not allow them to be extended completely on one side.

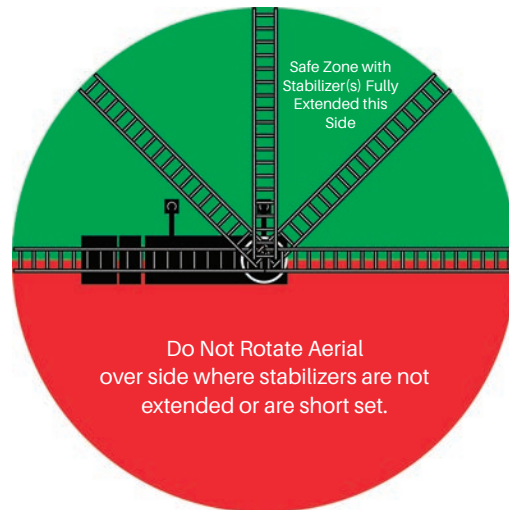

Figure 4-2. Short Set Rotation Interlock Stop Points

Set up the apparatus so that the stabilizers can be sufficiently extended in the direction that you will be working and extend them as far as possible on the opposite side. If a stabilizer beam is not extended far enough to achieve a load rating, you will not be able to safely rotate the device over that side. Whenever possible, a safety officer should observe aerial operations when you are using short-jack procedures.

OPERATING YOUR AERIAL SAFELY

Primary Control Operator

Operation of your aerial requires a qualified operator to be stationed at the primary controls on the turntable of the device at all times. You must also have a qualified operator at the controls any time there are personnel on the device, even if the device is not moving. The primary operator must be thoroughly trained, experienced and authorized by your department to perform primary control operation. A primary operator at the turntable controls is responsible for the safety of the operation, and is there to make immediate changes as needed to avoid imminent or changing hazards such as:

- Heat.
- Flames.
- Wind speed.
- Icing conditions.
- Wind and smoke direction.
- Power lines.
- Structural obstacles.



Secondary Control Operator

Your apparatus may have secondary controls at the tip of the ladder or at the platform bucket. These controls are only meant to be used with an authorized operator still at the primary controls. The primary operator must be prepared to override the tip or platform bucket operator if unsafe conditions are encountered. Both operators should be in communication with each other and with other personnel on the device at all times. If your apparatus is not equipped with a platform, keep the aerial ladder extended and use the fold-down steps with toe-guards and keep your fall protection tether secured to the device.

Use of a Spotter

During operation you may find that you are not able to see clearly through smoke or fog, or due to obstructions located on the far side of the device from where the controls are positioned. In situations such as these, you must use a spotter. Agree upon and train using standard verbal commands and visual signals until the team can perform operations safely and efficiently. If multiple spotters are required to ensure that all blind spots are covered, practice methods of ensuring that only one spotter at a time is giving directions.

Avoid Overhead Power Lines

Power lines are everywhere, and they present an extreme hazard to you and your aerial device. Unlike utility bucket trucks, your device is not insulated and will conduct electricity. Electrical arcs will burn, maim and kill you and others on or around the device if you get too close to them.

- Look up and Live. Always watch for power lines overhead.
- If operating at night, use powerful lights to search for power lines or poles.
- Stay 20 feet from power lines less than 350,000 volts.
- Stay 50 feet from lines over 350,000 volts or if the voltage is not known.
- Account for the swaying or bouncing motion of both the power lines and the device.

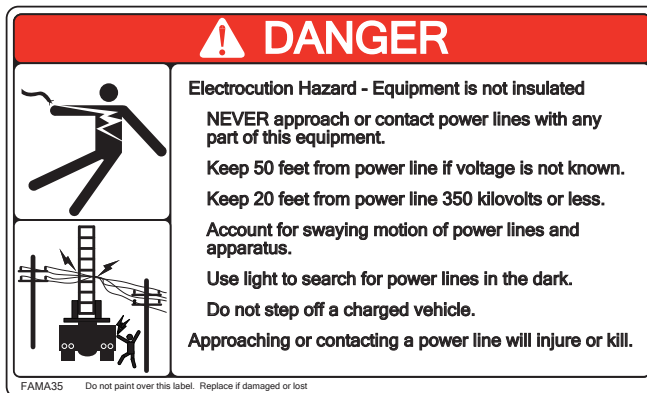

Extra Precautions Around Power Lines

If your apparatus is being operated around power lines you must take extra precautions. If the apparatus contacts a power line it will be electrified and the current will seek a path to the ground. If you are standing on the ground and touching the apparatus at the same time, you will be electrocuted. It is safer for you to be either completely on the apparatus, or completely off it and not touching it. If your apparatus includes a pump it will have a pump operator platform. Always stand on this platform while operating the pump so that you will be safer if your apparatus becomes electrified.

If Your Device Becomes Electrified

If you are on or inside a vehicle that becomes energized by a power line, stay where you are. Exiting the vehicle is more hazardous than remaining on it. Stay in or on the vehicle until a power company representative informs you that the line has been de-energized, grounded, and that the area is safe.

If it is critical that you leave the vehicle, JUMP as far away as possible, landing with both feet together. Maintain balance or fall forward; don't fall back towards the vehicle which could result in your body becoming a pathway between the vehicle and the ground. No part of your body should touch the vehicle and the ground at the same time.

If you are outside of the vehicle that contacts or is energized by a power line, move away from the vehicle, and stay away. Warn others to stay away.

Rungs Aligned

Before allowing personnel to climb a telescoping aerial ladder or the ladder section of an elevating platform, you must ensure that the rungs are aligned. This will allow personnel to maintain proper foot angle while climbing and avoid the possibility of their feet getting caught between misaligned adjacent rungs. Your controls will indicate when the rungs are properly aligned for climbing. Always observe your ladder rungs directly to ensure that they are aligned.

Fall Protection

Any time you are climbing your device or operating from the platform bucket you must be wearing a ladder belt and tether or other approved fall protection PPE. The belt or PPE should be properly sized to fit you, and the length of the tether should be selected by the fire department safety officer based on your department's procedures.

If you are operating from inside the platform bucket, tie off to a fall protection anchor indicated by this symbol:

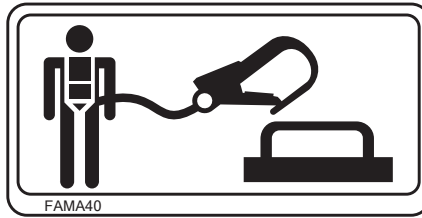

If you are on the ladder, tie off to a structural feature of the ladder such as a rung that will not allow the tether hook to slide downward. Do not tie off to non- structural features such as wires, cables, lights, brackets, etc...

You must be tethered to a structural feature of the ladder or platform bucket any time:

- The device is in motion.
- You are not actively entering or exiting the platform bucket.
- You are not actively climbing or descending the ladder (If you stop at any point during your climb, connect your fall protection to a ladder rung).



Climbing the Aerial Ladder

The National Institute of Occupational Safety and Health has considered the aspects around determining the optimum ladder elevation for climbing. NIOSH points out that there are several variables that must be considered when positioning an aerial ladder. One of these variables is the angle of elevation that is best for climbing. Steep angles of climb, even when kept within accepted standards, can make climbing and tool carrying more difficult for some persons.

Choosing an optimal climbing angle may require more than simply implementing a 1:4 or 75 degree angle “rule”. This rule has been derived from OSHA standards that may not account for to the heights firefighters may climb nor the bulk, weight and positioning relative to the body of the tools that they carry. Firefighters’ tools, PPE and SCBA place burdens on the body that should be considered. Adjust your angle of climb accordingly to minimize stress on climbers and allow them to maintain balance during the climb.

Use three points of contact and grasping the rungs as you climb. Grasping the rungs has several safety advantages over holding onto the rails:

- Your hands have more holding power when they are grasping a round bar than when they are grasping a rectangular object.
- If your feet slip and you are holding onto the rails, your hands may slide down the rails, and you may fall. If you are holding on to the rungs, it is more likely that your hands will have enough grip force to help you recover.
- If your feet slip and you are holding onto only one rail at the time, the weight of your body will be offset from your line of grip and your body will twist. If you are holding onto the rung, your grip force is lined up with your body, and your chance of staying in control is much greater.

There are four times as many falls from descending as from ascending a ladder. Pay close attention to your footing on the way down.

Water Towers

Your apparatus may be equipped with a water tower boom that is not equipped with a ladder and not designed to carry people. Keep personnel off the apparatus during any boom operation. The boom is designed for fire suppression only and is not designed nor equipped for carrying people. Do not climb or ride on this equipment, and do not allow others to do so.

- Do not climb or ride on boom.
- Do not lift people.
- Do not lift objects.

Boom Style Platform

Your apparatus may be equipped with a boom-style platform bucket that is not equipped with a ladder and not designed to carry people. Keep personnel off the boom during operation. The boom is designed for supporting the platform bucket only and is not designed nor equipped for carrying people. Do not climb or ride on the boom, and do not allow others to do so.

- Do not climb or ride on boom.
- Do not lift people.
- Do not lift objects.

Wire Rope Hazard

Your aerial device uses wire rope (cables) to extend and retract the ladder. Anywhere wire rope comes close to or contacts other mechanical parts such as pulleys, sheaves, roller guides or structural features on the device, a pinch hazard may exist. Anyone operating, climbing on, or supervising others on an aerial device that uses wire rope should study the wire ropes and follow these safe practices:

- Stay clear of wire rope, pulleys, and sheaves during operation.
- Never touch wire rope while someone else is at the control or during operation.
- Never touch wire rope while in tension or under load.



Operating With Personnel on the Aerial Ladder

You must never allow personnel to climb, ride or work on your aerial device unless they are thoroughly trained in safe operation and the importance of using the three points of contact method of climbing. Make sure that when people are climbing while carrying equipment that they have such equipment in their pockets or tethered to themselves in a way that allows them full use of both feet and both hands.

Before allowing climbers ensure that the ladder will not move. Do this using one of the following methods (depending on device design).

- Stand away from the controls.
- Lock the system using the system lock.
- Remove your foot from the operator present foot switch.
- Depress the Emergency Stop button or machine stop button.

Never extend or retract the ladder with people on the ladder unless they are at the secondary operator station at the ladder tip and their feet are securely on the supplied folding step(s). Never retract the ladder past where the section overlaps the secondary operator position. Extending or retracting the ladder with climbers on the ladder will crush their hands or feet.

Never rotate, raise, or lower the device unless personnel are secured to a structural feature with a ladder belt and tether.

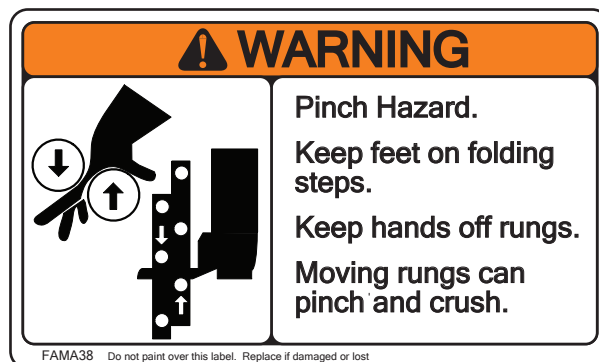

Ladder Base Pinch and Crush

Your aerial device is made from heavy structural parts that are constantly moving past each other during operation. This creates dangerous pinch or crush hazards all around you. You must study your device carefully and keep yourself and others well clear of these areas during operation. Never allow people to hold onto or lean against the device while they are waiting for you to position it.



Operating with Personnel Near the Aerial

There may be times during operation when other personnel are working in the same vicinity. Instruct and train your department personnel that they should approach a working aerial device apparatus only after getting the all-clear from the primary control operator. Keep personnel clear of swinging structures and other moving parts. Keep them away from the area beneath the device and from around the apparatus. Items accidentally dropped by personnel on the device may injure or kill those below. Falling items may bounce off the ladder, turntable or other parts of the apparatus and strike personnel at some distance from the apparatus. Take extra precautions during icing conditions to keep personnel from being injured by ice falling from the device.

Operating Within Safe Limits

Your aerial device will have a load chart that is specific to your device make and model and will be located near the primary operator station. You must study and memorize your load chart so that you will not need to refer to it constantly during operation. The load chart criteria should be so familiar that you can instantly recognize when the device is nearing a critical or overload condition.

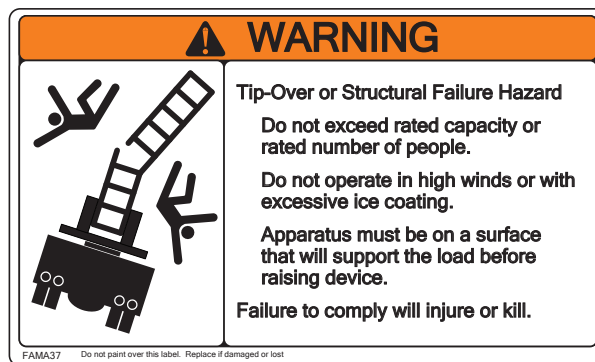

Your load chart will tell you how many people you can have in various locations on the device depending on the elevation of the device, whether you are flowing water or not, and whether you are leveled within the green or yellow zones. Your device can support more people as the angle of elevation increases.

SAFETY

The safety of your operation also depends on factors that cannot be measured precisely and may change rapidly including:

- Level condition (Green or Yellow).
- Monitor water flow and direction.
- Wind speed.
- Wind gusts.
- Ice build-up.

You must be familiar with conditions that will reduce the capacity of your device and stay alert to changes in these situations.

You should always operate the device slowly, carefully and cautiously. Keep in mind that the load ratings on the chart are static ratings. This means that they assume only the weight of the personnel or equipment is acting on the device without bouncing or other sudden changes. Dynamic loading may be much higher than a static load. Do not allow personnel to bounce, swing or jump onto the device.

Load Chart Limits and People on the Ladder

Your load chart will indicate the maximum number of people that can be placed on each section of your ladder depending on the position of the device. Never exceed these limits.

Over 250 Counts for Two - the load chart is valid only if each person does not weigh more than 250 lbs. (113 kg) including clothing, gear, etc. If you have a person on your device who is significantly heavier than this value you must adjust accordingly. For persons who are heavier than 250 lbs, count them as if they were two people.

FAMA studies have shown that the average firefighter with PPE and SCBA weighs 250 lbs. (113 kg) NIOSH studies suggest this value may be even higher. Take the time to weigh your personnel in PPE, SCBA, and the equipment they will have while climbing so you know when to adjust for heavier personnel.

One Person One Rung - the load chart assumes that people on a ladder are never sharing a rung. Keep your climbers spread out appropriately.

Approaching Structures

Your aerial device is designed to handle loads in the downward direction only. It will be damaged if it is loaded by resting the tip on a structure, powering it down onto a structure, powering it into the ground, or by using it to span a structure like a bridge. It may also be damaged if it is rotated into a structure. Never use it as a battering ram to knock over structures, break windows, or for any purpose other than fire suppression or rescue operations.

Never push or pull sideways on your aerial device. Do not use it as a crane.

During rescue operations, always aim the tip of your device above the victim and the structure and slowly lower toward the target. Stop the device 6.0 in. to 12.0 in. (152.4 to 304.8 mm) above the target. Personnel weight on the device will then cause the device to settle onto or just above the structure without risking a reverse-loading condition.

Operating Above Structures

There are times when you may wish to extend your aerial device over the top of a structure. Do not do this if there is a risk of a flashover or sudden roof ventilation. You should never position the device over high heat or open flame as exposure to high temperatures will weaken structural members, melt wires and hoses, and present a hazard to personnel on the device.

Icing Conditions

If you are operating your aerial device in freezing temperatures, you must be alert to the possibility of ice forming on the device. This can happen from freezing fire streams, freezing rain, freezing fog, or snow that melts and then re-freezes. You must use extreme caution when retracting or extending an aerial device that is coated with ice, both for the safety of personnel and to protect the device from damage. Keep personnel clear of the path of falling ice. Move the device slowly to allow ice to fall away.

Inspect the device thoroughly after operation in an icing condition as the operation with an ice coating can damage many components of the device and render it unsafe for future use.

Windy Conditions

High winds can tip over any aerial device. See your load chart to determine what wind speed your device is rated for. You must then select a method that you will use to determine the wind speed while you are operating. The best method is a wind speed indicator mounted at the tip of the device. You can estimate wind speed in an emergency using the Beaufort Scale if your wind speed indicator quits working or is unavailable.

Table 4-3: Beaufort Scale (For Reference Only)

Beaufort Number	Wind Speed (mph)	Description	Land Conditions
0	0	Calm	Calm. Smoke rises vertically.
1	1-3	Light Air	Wind motion visible in smoke.
2	4-7	Light Breeze	Wind felt on exposed skin. Leaves rustle.
3	8-12	Gentle Breeze	Leaves and smaller twigs in constant motion.
4	13-18	Moderate Breeze	Dust and loose paper raised. Small branches begin to move.
5	19-24	Fresh Breeze	Smaller trees sway.
6	25-31	Strong Breeze	Large branches in motion. Flags waving near horizontal. Umbrella use becomes difficult.
7	32-38	Near Gale/Moderate Gale	Whole trees in motion. Effort needed to walk against the wind.
8	39-46	Fresh Gale	Twigs broken from trees. Cars veer on road.
9	47-54	Strong Gale	Light structure damage.

Wind speeds usually increase the higher up you climb, and the wind speed at the tip of the device will have the greatest over-turning impact. Retract and stow your device before the wind conditions increase above the wind speed rating.

SAFETY

Just because your device is rated for a certain wind speed does not mean it is safe for people to be operating on the ladder or in the platform. High or gusting winds will be a hazard to climbers and people in a platform bucket. Consider removing people from the device in high winds and using the device for water delivery only.

Flying Flags

Your department may wish to use your aerial apparatus for tasks it was not designed for. Any use other than fire suppression or emergency rescue is not recommended. Flying flags, for instance, is a popular practice, but the forces imposed on your device are unpredictable and may exceed the load chart ratings. The risk increases as the wind speed and variability increases. Your safety officer should study any such practice carefully and take responsibility for the safety of the apparatus and for personnel in the area. Never exceed the load chart ratings.

Lightning Threat

Your apparatus will not protect you from lightning strikes. To avoid the risk of death or injury, retract your device and seek shelter before lightning storms enter your area.

Rope Rescue

Your aerial device may be equipped with a feature to facilitate rope rescue operations. The top portion of this feature may be an anchor point on your platform bucket, or a pulley device that attaches to the tip of your ladder. The bottom portion of this feature may be a fixed tie-off appropriately labeled near the base of the ladder, or a Change of Direction Bar that attaches to the ladder near the base of the ladder. Only use these provided features and/or devices to perform rope rescue with your apparatus.

Your apparatus is not a crane, and it is not designed to be used as such. Refer to your apparatus load chart. The weight that you lift should never exceed the load chart ratings, and it should never exceed the rated capacity indicated on the rope rescue anchors or change of direction bar. Anchor points or devices provided with your apparatus are intended to be used as a single anchor for a single rescue rope only.

To ensure that the capacity is not exceeded, it is essential that you lift in a smooth manner, without causing the device or the load to bounce, jerk or sway. Use appropriate methods to stabilize the load while it is being lifted.

If you are using the pulley provided for rope rescue, or if you have attached a single pulley to the anchor on your platform bucket, the working end of the rope must follow along parallel with the ladder to the turntable anchor, or be passed through the Change of Direction Bar pulley properly attached at the turntable. In this configuration, the rope will be raised when the device sections are extended and lowered when the device sections are retracted. Never use additional pulleys or block and tackle as the load on the device will be multiplied.

The working end of the rope should never be anchored to other parts of the ladder, other parts of the apparatus, static structures, or to objects on the ground. If the rope is anchored to a point that is not in-line with the ladder, the load on the device will be doubled and you will exceed the ratings and overload your aerial device. Overloading will risk device damage, tipping or collapse leading to injury or death.

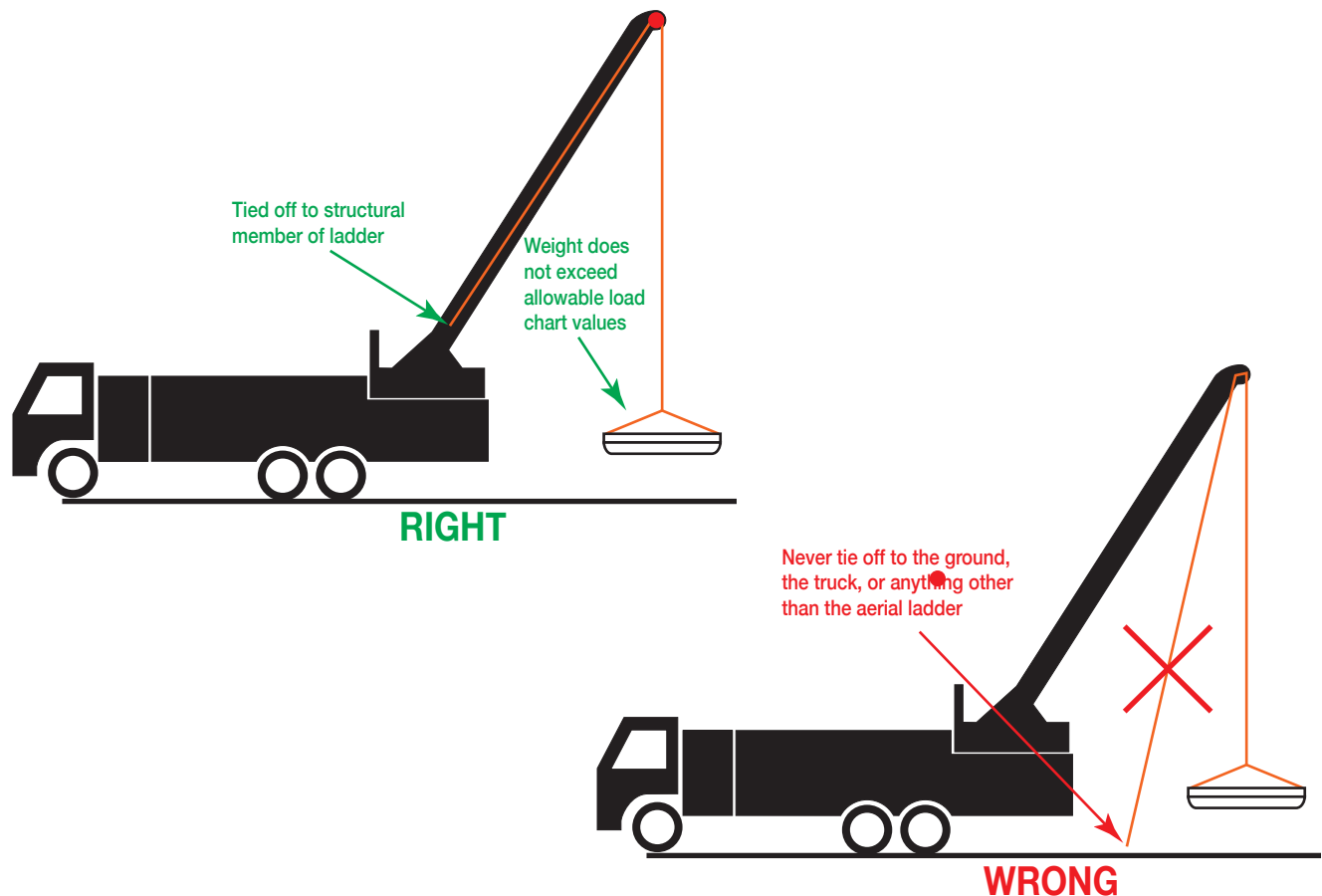

Proper rigging for rope rescue, attachment of ropes to rescue baskets, and all other operations involved in rope rescue other than those outlined in this manual are the responsibility of you and your department. Guidelines that you may find useful when determining how to safely perform rope rescue operations with your apparatus include:

- **NFPA 1983** *Standard on Life Safety Rope and Equipment for Emergency Services.*
- **NFPA 1670** *Standard on Operations and Training for Technical Search and Rescue Incidents.*
- **IFTSA** *Fire Service Technical Search and Rescue manual.*

Positionable Waterway Monitor

Your device may be equipped with a pre-piped waterway that allows the monitor to be positioned at the tip for fire suppression, or on a lower section for rescue. If your device includes this feature it is essential that you always be sure that the monitor is secured in its anchor. If water pressure is applied when the monitor is not securely anchored, the pressure will cause the waterway to extend rapidly on its own. The rapid movement of the pipe sections can damage equipment or harm people who may be on the ladder at the time. Study the waterway on your device, understand the monitor anchoring mechanism, and always be sure the monitor is secured prior to charging the waterway.

SAFETY

Aerial Ladder Pipe Operation

Your department may choose to use a ladder pipe nozzle supplied by a fire hose that you lay along the ladder rungs. Only use this method with extreme care and under the supervision of trained personnel who understand the extra loads created by the weight of the hose and the reaction forces of the nozzle. Use only ladder pipes designed for the application and follow all ladder pipe manufacturer operator instructions and fire industry best practices.

Lay the hose along the middle of the ladder so that it rests on the rungs only. Tie off the hose so that it stays in the middle of the ladder when charged. Never hang the hose off the side of the ladder. Never use more than one ladder pipe nozzle and hose on your aerial ladder. Do not use an aerial ladder pipe and fire hose on an apparatus that is equipped with a pre-piped waterway and water monitor.

TRACTOR DRAWN AERIAL OPERATIONS

Tiller Cab Safety

When operating from the tiller cab, follow the same safety procedures that you would follow if you are driving the tractor (see Riding Safety and Driving Safety in this manual) including the following:

- Seat Belts: Seat belts in good condition. Seated and belted prior to vehicle motion.
- Seat Adjustment: Seat adjusted to allow proper reach of operational controls.
- Doors: Doors fully closed and latched.
- Helmets: Helmet off and secured for travel.
- Equipment Secured: No loose equipment in the cab.
- Mirror Adjustment: Mirrors and/or cameras adjusted properly.
- Visibility Check: Glass clean and free of fog or ice, wipers operational, defroster operational.

Tiller Steering Lock

If your apparatus is a tractor-drawn aerial there are two ways in which the trailer can be towed, with the rear steering functional or with it locked. Always check the steering lock before placing the vehicle in motion unless you have a tiller operator at the wheel. Driving without a tiller operator while the steering is unlocked will cause the trailer to steer uncontrollably.

Never attempt to lock or unlock the steering with the apparatus in motion.

Tiller Steering

If you choose to operate your aerial tiller with the rear steering unlocked, you must have a tiller cab operator seated and belted prior to placing the apparatus in motion. The tiller operator must be alert at all times to keep the trailer tracking behind the tractor, or to avoid traffic and other road hazards.

Tractor Operator Training

Obtain a Class-A Commercial Driver's License or the equivalent fire department training and authorization prior to driving from the tractor position. This training must include the special aspects of driving a heavy combination vehicle.

Tiller Operator Training

The tiller operator must be trained, experienced, and authorized to occupy this role. Training should be conducted under supervision and in a controlled location.

Fifth Wheel Lock

Your tiller aerial apparatus may include a feature to lock the tiller trailer turntable connection (fifth wheel) from articulating up and down. It does not lock the connection from rotating. This locking feature is critical to providing stability while the ladder is being operated. This lock allows the weight of the tractor to contribute to stability. If you attempt to operate the ladder without the fifth wheel locked, the ladder could tip over.

The fifth wheel must be unlocked before moving your apparatus. Driving your apparatus with the fifth wheel locked would cause uneven loading on the axles. This could lead to serious driving hazards including reduced steering control, reduced braking control, and poor handling. Never place your apparatus in motion unless the fifth wheel is unlocked.

PERFORM MAINTENANCE SAFELY

Maintenance Records

The safety of your apparatus will depend on how well it is maintained, and good maintenance depends on keeping accurate maintenance and repair records. Maintenance and repair records should be maintained as permanent records and kept in a secure location. Acceptable records include itemized bills, dealer work orders, owner's vehicle log, and service facility receipts, stating the date service was performed.

Vehicle Identification Number (VIN), mileage (kilometers), engine hours, and service performed. Consult **NFPA® 1910 Standard for the Inspection, Maintenance, Refurbishment, Testing, and Retirement of In-Service Emergency Vehicles and Marine Firefighting Vessels** for apparatus inspection and maintenance recommendations.

Use OEM Parts for Repair

- Your apparatus is designed to operate as a system. Every part has been selected to ensure proper performance. While some common service parts such as fluids and filters may be available from heavy truck supply sources, purchasing repair parts from any place other than your authorized dealership may put the safety or performance of your apparatus at risk. All safety-critical components should always be sourced through your authorized dealer including:
 - Chassis structural components.
 - Chassis steering, suspension, and brake components.
 - Apparatus related electronics.
 - Aerial and stabilizer hydraulic cylinders including valves and manifolds.
 - Hydraulic rod-end pins, hardware, and locking devices.
 - Ladder or boom slide pads.
 - Aerial extension cables, sheaves, and anchors.
 - Turntable rotation bearings, rotation gears, drive gears, and motors.

SAFETY

- Rotation sensing components (proximity switches, encoders, limit switches, etc...).
- Extend or retract sensing components (proximity switches, limit switches, etc...).
- Stabilizer extension sensing components (proximity switches, limit switches, etc...).
- Jack plant sensing components (proximity switches, limit switches, etc...).
- Wire harnesses and connectors.
- Wire bulkhead connector or other pass-through component for wires entering rung rails or hand rails.
- Corrosion inhibitor material for the interior of aerial ladder structural tubes.
- Mounts for securing equipment on the device (pike poles, roof ladders, etc...).
- Safety signs, load charts, and other instructional material.
- Hydraulic tubes, hose assemblies, fittings etc...
- Hydraulic valves, velocity fuses, filters, manifolds, solenoids, etc...
- Rotation swivel and associated components.
- Waterway including mounting brackets and seals.
- Cable tracks, raceways, and associated components used to guide cables and hoses (igus or similar).
- Rung covers.
- Aerial control valves, switches, levers and joysticks.
- Aerial motion control computing devices (plc or similar).
- Aerial remote control receivers, transmitters, controls pads, tethers, and associated equipment.
- Optional equipment such stokes basket mounts, rope rescue pulleys and anchors, parapet ladders, etc...
- Fall protection anchors.
- Platform basket components including doors, gates, latches, handrails, etc...
- Stepping, standing, and walking surfaces.
- Access ladders and handrails.

Running the Engine

Unless a maintenance routine specifically states otherwise, turn off the engine and all other equipment prior to performing maintenance tasks.

Preparing for Maintenance

Remove all jewelry prior to working on your apparatus. Metal jewelry is a conductor and can cause burns if in contact with electrical power, and other injuries if worn while performing maintenance. Rings can get caught on projections leading to loss of fingers. Hanging jewelry can get caught in moving machinery.

Always use appropriate PPE including gloves, eye protection, hearing protection, safety shoes, and protective headwear when working on your apparatus.

Depressurize air, hydraulic and cooling system lines prior to removing or replacing components.

Ensure working areas are free from oil, grease, and foreign materials.

Compressed Air for Cleaning - DO NOT USE

The use of compressed air for cleaning is not recommended. Using compressed air for removing debris creates an environment of propelled foreign particles, which can cause injury to personnel.

Chemicals and Cleaners

Use only non-flammable solvents for cleaning component parts.

Keep chemicals and cleaners in approved safety containers and in minimum quantities.

Use approved protective equipment and clothing, such as gloves, apron, and eye protection, when handling chemicals and cleaners. Some chemicals have an adverse effect on skin and eyes.

Ensure adequate ventilation when using chemicals and cleaners. Some chemicals have an adverse effect on the respiratory tract.

Observe all manufacturers manuals, warning labels and current safety directives.

Use chemicals and cleaners in authorized areas only.

Dispose of all soiled clothes and materials in accordance with national and local directives for hazardous waste.

Decontamination Chemicals

Decontamination chemicals that contain hydrogen peroxide (such as Decon 7) should be used with caution and strictly following the manufacturer's instructions. Hydrogen peroxide is an oxidizing agent that will cause corrosion when applied to bare metal. It will also damage exposed electronics.

Follow these guidelines:

- Apply in the cab interior as a fine fogging mist only. Do not spray directly on bare or unfinished metal surfaces, or painted surfaces that have been scratched or marred.
- Do not spray or foam on switches, gauges, display screens, or other electrical or electronic devices.
- Remove accidental over-spray using water and a clean cloth.

Always follow the manufacturer's safety recommendations while working with decontamination chemicals including:

- Use only EPA registered products.
- Avoid breathing mist or vapors.
- Wear Gloves (resistant to chemical products [butyl rubber, nitrile and neoprene, polyethylene, polyvinyl chloride]).
- Wear protective clothing.

SAFETY

- Wear eye protection (face shield or safety glasses).
- Wear Respiratory protective equipment (air respirator or SCBA).

Tilting the Cab

Always ensure that the vehicle is on a flat and level surface before tilting the cab. Tilting the cab on an inclined or non-flat surface may produce interference between components as the cab is lowered.

Before tilting cab:

- Check the front bumper and bumper extension to ensure that covers are shut and plumbing swivels are rotated forward. Remove all loose items from the cab as contents may shift or drop.
- Close the crosslay cover and stow any other body related feature that hangs over the cab.
- Raise any aerial device if located over the top of the cab.
- Ensure that there is clearance above the cab and the area is clear of power lines.

Always check to make sure that people working on or around the cab are clear before raising or lowering the cab. Immediately after raising ensure that the stay-arm or mechanical support is secured in the support position. Hydraulic cylinders can leak or drift and should not be relied upon to support the cab on their own.

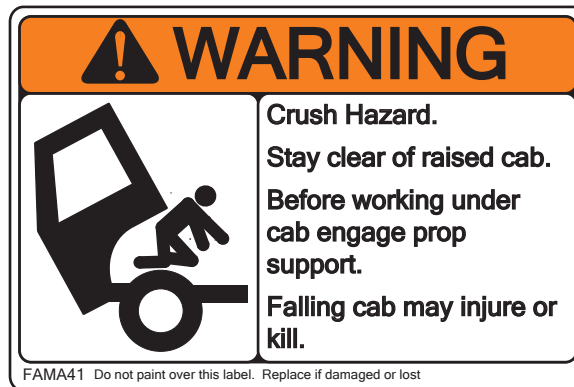

If the cab fails to lower after following the proper instructions, do not attempt to force it. Have the system checked by a qualified technician and refer to the cab tilt system instructions in the service manual.

Lock-Out Tag-Out

You may come across an apparatus in your facility with a sign that says Lock-Out Tag- Out (LOTO) on it, or you may need to perform work where LOTO procedures are required. LOTO is the procedure used for preventing the unexpected release of hazardous energy while servicing and maintenance activities are performed.

Never operate a vehicle or equipment that is marked with LOTO devices. Always use LOTO procedures as required; failing to do so may expose you to hazards associated with hazardous energy sources. Follow your department procedures, which should conform to **OSHA 1910.147** regulations.

Access Features Not Provided

Your apparatus may have methods to access equipment or machinery for service or periodic maintenance. These areas may or may not be equipped with a means of access that allows three points of contact at all times. If it is necessary to climb onto, into or around portions of your apparatus that are not equipped for three points of contact, special accommodations must be made for safe access in a controlled, service environment. Use overhead safety harnesses and tethers, step ladders, access platforms, scaffolding or other means to ensure that service and maintenance personnel are protected from stepping, standing and climbing hazards.

Confined Space

Your apparatus may contain spaces such as water tanks that are considered to be “confined” because their configuration hinders the activities of employees who must enter into, work in or exit from them. In certain instances, employees who work in confined spaces also face an increased risk of exposure to serious physical injury from hazards such as entrapment, engulfment and hazardous atmospheric conditions. Confinement itself may pose entrapment hazards, and work in confined spaces may keep employees closer to hazards such as machinery components. Limited access and restricted airflow can result in hazardous conditions that would not normally arise in an open workplace.

OSHA’s standard for confined spaces (29 CFR 1910.146) contains the requirements for practices and procedures to protect employees, in general industries, from the hazards of entering confined spaces. Evaluate your apparatus to determine if there are confined space hazards and take proper precautions before working in a confined space. Use lock-out /tag-out procedures where appropriate.

Welding

Your chassis has high-strength steel frame rails that should not be welded on unless you are following a specific factory authorized repair procedure. Welding on your chassis frame in any manner not prescribed by the factory may result in serious structure failure.

Your apparatus includes electronic components that can be damaged from the high voltage and current generated during the welding process leading to apparatus failure.

Disconnect electronic devices prior to welding on your apparatus including:

- Bosch or WABCO ABS ECU.
- Cummins Engine ECU.
- Allison Transmission Control Module (TCM).
- Foam Pro foam system ECU, pump, and gauge connections.
- Flasher modules.
- Side Roll and Frontal.
- Occupant Protection system ECUs.
- Multiplex system modules.

Do not weld on galvanized frame rails or other galvanized components as serious adverse health reactions may result.

SAFETY

Interlocks

Your apparatus may include protective interlocks that modify or prevent certain functions. These interlocks were designed into your vehicle for your safety and the safety of your operators. Never place an apparatus back in service unless all factory interlocks have been restored to their proper function. Never bypass a safety interlock device.

Batteries

Always wear safety goggles and protective clothing when working on or around batteries. Do not check battery condition by shorting across terminals. Inhaling hydrogen gas produced by the normal operation of the battery could result in partial or permanent damage to the respiratory system. Battery posts, terminals and related accessories contain lead and lead compounds — chemicals known to cause cancer and reproductive harm. Wash hands after handling.

Before servicing batteries on your apparatus, become familiar with safe handling techniques. Batteries give off hydrogen gas that is highly explosive. Keep all sources of ignition away when working around batteries, including matches, lighters, and cigarettes. Sparks caused by connection of battery terminals, jumper cables or charging systems can be a source of ignition. Whenever disconnecting battery terminals, always disconnect the ground terminal first. When reconnecting, always connect the ground terminal last. Do not attempt to jump-start a vehicle having a frozen battery because the battery may rupture or explode. If a frozen battery is suspected, examine all fill vents on the battery. If ice can be seen, do not attempt to start with jumper cables. Thaw out battery before jump-starting or recharging.

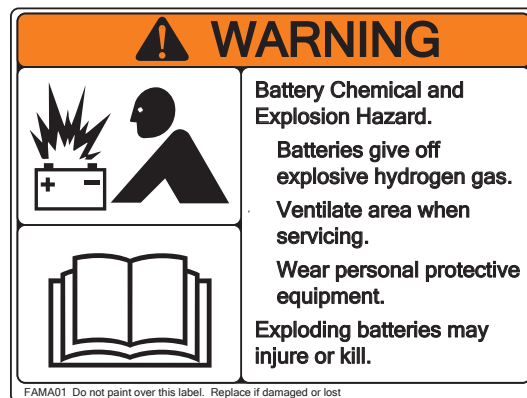

Battery Charging

Never disconnect a battery while charging; this could cause sparks.

Do not use battery charging equipment in the rain, in areas used for washing or in damp areas.

Gases generated during charging are explosive. Do not smoke in the vicinity of the batteries. Use battery chargers only in well ventilated areas.

Before starting to charge, make sure the voltage of the equipment suits the voltage of the battery, that the charging current suits the capacity of the battery and that the selected charging curve (for lead-acid batteries or airtight gel batteries) is correct for the type of battery to be charged. In addition, make sure the rated input voltage of the charger suits the available supply voltage and the system is equipped with grounding.

High Pressure Hydraulic Fluid

Your apparatus develops high pressure fluid in the fuel lines of your engine. You may also have features powered by high pressure hydraulic fluid. If you see or suspect a fluid leak, shut down the equipment and call a service technician trained in safe methods of troubleshooting and servicing high pressure equipment.

Never search for leaks with your hands or other body parts. High pressure fluid can penetrate skin. Use a piece of wood or cardboard to detect leaks, keeping hands and other body parts well away from the potential source of the leak.

If you suspect that you have been exposed to high pressure fluid through skin penetration, seek medical help immediately. The high-pressure injection of a fluid such as fuel, hydraulic oil, grease and paint constitutes a medical and surgical emergency, requiring access to appropriate, surgical specialists as soon as possible. Often, the injury appears minor; don't be fooled. Fluids injected under the skin are highly toxic. The injury will lead to gangrene, amputation or death if not treated promptly.

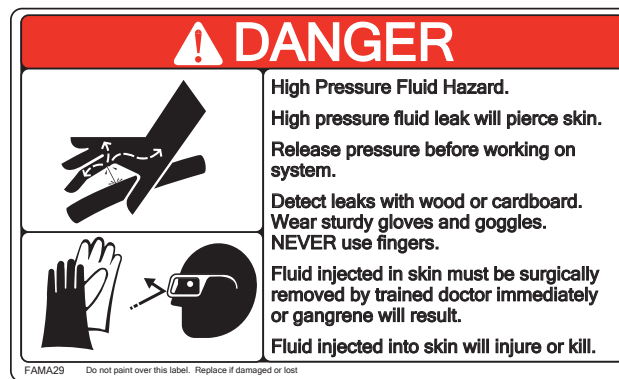

Aerial Device Equipment Mounting

Anything mounted on your aerial device subtracts from the load capacity. Your load chart assumes that you have not mounted any additional equipment or modified the device in any way. Never add any equipment or mounting provisions that add weight to the device without written permission from this manufacturer.

Aerial Device Inspection

Your aerial device is a complex machine that requires constant care and thorough inspection. Study your aerial device's manufacturer's operation and maintenance manuals, the *IFSTA Pumping and Aerial Apparatus Driver/Operator Handbook*, and the **NFPA® 1910 Standard for the Inspection, Maintenance, Refurbishment, Testing, and Retirement of In-Service Emergency Vehicles and Marine Firefighting Vessels** to determine the critical points on the device that should be regularly inspected. Inspect these points and look for signs of wear, corrosion or impending failure.

Critical points of inspection should include, but not be limited to:

- Pins.
- Cables (Wire Rope).
- Sheaves.
- Lighting.

SAFETY

- Cylinders.
- Wire Insulation.
- Wear Pads and Surfaces.
- Weld Joints.
- Electrical Cabling.
- Mounted Equipment.
- Slip Resistant Surfaces.
- Structural Members.

Follow the **NFPA 1910** recommendations for annual inspection.

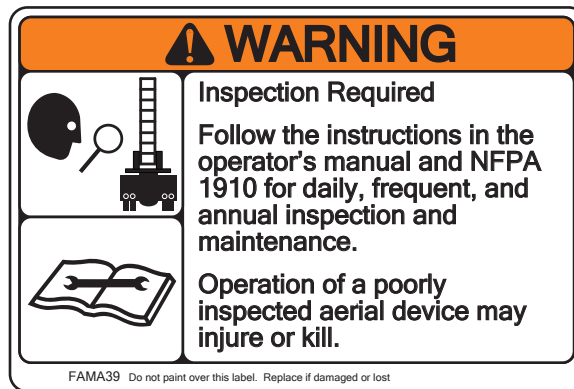

Radiator Cap

The radiator cap serves an important function. It holds the pressure of the cooling system so that coolant flows continuously through the radiator. You may need to remove the radiator cap on occasion to fill the radiator with coolant or to test the cooling system. Before attempting to remove the cap, allow the radiator to cool down completely. The cooling system is both hot and under pressure. At normal operating temperature, the coolant can reach several hundred degrees Fahrenheit, cause serious burns on your skin, or cause you to go blind if it gets into your eyes. To prevent splashing, cover the cap with a rag.

Seat Belt Inspection and Replacement

You should inspect the seat belt components of your apparatus regularly to ensure they will function properly in a crash. Webbing can be abraded, soiled, or torn more quickly in a fire apparatus than in your personal vehicle due to the heavy duty service they will experience. The entire seat belt assembly should be inspected for corrosion, wear, fraying, or weak spots. The retractor, latch and buckle should be checked for proper function, and all seat belt mounting bolts should be tight at all times.

Seat belt webbing should be considered for replacement at least every five years. Replace seat belts as a complete assembly. Replace any seat belt assembly that is exposed to a serious crash before the vehicle is placed back in service.

Do not bleach or dye seat belt webbing. Bleaching or dyeing may cause a severe loss of belt strength resulting in failure during a crash.

Inspect the seat belts as follows:

- Webbing should be free from frays, cuts, and excessive wear. Pay attention to the area near the buckle latch plate and in the D-loop guide area.
- Webbing should be clean, and not severely faded from exposure to the sunlight.
- Buckle receiver should slide together easily with a positive click when they latch.
- Sliding Komfort Latch® should operate properly.
- Seat belt retractor should retract the webbing completely with no or minimal assistance.
- All mounting bolts should be tight.

Side Roll or Frontal Crash Occupant Protection

Your apparatus may be equipped with inflatable occupant restraints (air bags), seat belt pretensioners, and suspension seat pull-down devices. These devices operate in a split second and are powered by pyrotechnic (explosive) charges. Never attempt to remove, modify, or repair any of these devices without the express permission and instructions from a factory representative. Tampering with or removing an inflatable occupant protection system sensor (the black box that controls the firing of the devices) can cause the devices to fire which may lead to injury or death. Consult the factory before attempting any removal, modification or repair of any air bag, air bag sensor, seat belt pretensioner, or suspension seat pull-down device.

Pyrotechnic devices can be dangerous if modified or removed. When activated in a crash or rollover they will exhaust harmless blue smoke. Never service, attempt to salvage, or reuse side roll or frontal protection components. Never weld or apply heat on or near side roll or frontal protection components. Never grind, puncture, or drill on side roll or frontal protection.

Information on all component caution and warning labels must be complied with. Labels are placed in visible locations on each component of the Side Roll Protection System. If labels have been removed or are not visible, please contact your customer service representative for the proper replacement labels.

After one of these systems has been deployed, the major components cannot be reused. The Suspension Seat Safety System (S4S), roll & slave sensor(s), Integrated Gas Pretensioners (IGP) / Integrated Belt Pretensioners (IBP), and Inflatable Head Curtains (IHC) / Supplemental Restraint Airbags (SRA) must be replaced. In addition, the wiring harnesses will require inspection and possible replacement. After all system components are inspected and/or replaced, the integrity of the system must be checked by an authorized technician. This service must be performed by a service facility authorized by customer service.

Suspension Seat Tethers

Your apparatus may include a suspension seat that uses a seat tether. Inspect each suspension seat and identify any web-type tether that connects the suspension seat to the cab floor structure. If the tether includes an adjustment feature, ensure that it is adjusted to allow full travel of the seat suspension only. The tether should be taut when the seat is adjusted to its full forward and upward excursion of travel.

Tire Inflation Pressure

Proper tire inflation is vital to the safety and performance of your apparatus and should be checked with an accurate tire pressure gauge only. Never reduce inflation pressure to attain a softer ride. Under-inflation causes excessive flexing within a tire, resulting in heat build-up which can cause a blowout. An under-inflated tire running at highway speeds and under heavy load can cause severe handling problems.

SAFETY

Tire Wear Inspection

Inspect tires for signs of abnormal or excessive wear. Sufficient tread depth is essential to proper handling and braking performance. Refer to the tire manufacturer's manual for minimum tread depth requirements. Replace tires before minimum tread depth is reached.

Tire tread life is dependent on many factors including the following:

- Tire load.
- Brake power.
- Engine horsepower.
- Suspension alignment.
- Proper inflation pressure.
- Frequency of tight cornering maneuvers.
- Driving habits of acceleration and braking.
- Tire footprint (area of rubber in contact with the road).
- Tandem scrub (inherent to all non-steering tandem suspensions).
- Frequency of dry-steer maneuvers (steering the vehicle in the absence of forward motion).

Tire Replacement

Tire rubber degrades over time, even if the tire is not used. Replace your tires after they have been on the apparatus for more than seven years, even if the tread is still satisfactory.

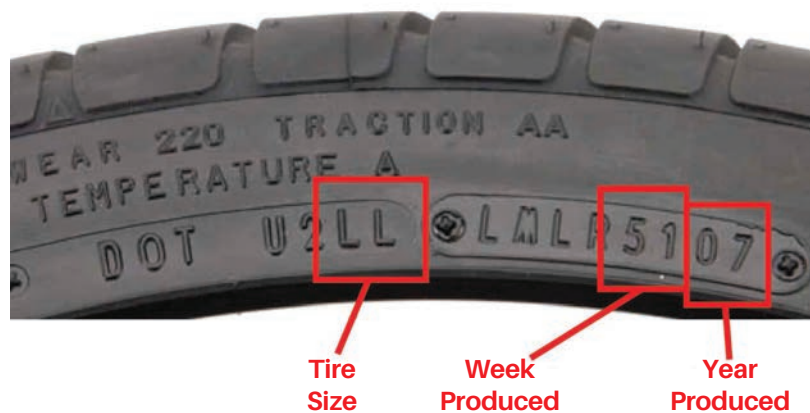

The tires installed on this vehicle at the factory as original equipment are certified for compliance with federal greenhouse gas and fuel efficiency performance regulations. In order to maintain the same level of tire performance, replacement tires must be of equal or lower rolling resistance level (TRRL or CRR). Consult with your tire supplier(s) for appropriate replacement tires.

Manual Parking Brake Release (Caging the Brakes)

If your apparatus must be towed and sufficient air brake pressure is not available, the spring brakes will need to be manually released or “caged.” Remember that caged brakes will not hold your apparatus from rolling. Never leave a vehicle with caged brakes unattended, park it on flat surface only, and chock the wheels in both directions before caging the brakes. Perform lock-out/tag-out to secure the vehicle and make sure no one drives it or removes the wheel chocks until repairs are complete.

Line-Voltage Components and Wiring

Your apparatus may be equipped with a line-voltage generator that produces high 120V, 240V, single or three-phase alternating current. Line voltage generators, components, wiring, and circuit protection should be maintained by qualified and authorized electricians trained in all aspects of the National Electrical Code (NEC) safety practices.

Disconnect power before removing any line voltage breaker box cover or junction box cover or working on line voltage wiring. Follow National Electrical Code safe practices. Electrical shock can injure or kill.

To avoid property damage, personal injury, or death, refer to the component manufacturer’s service information before working on any high voltage equipment. By definition, high voltage circuits and components contain voltage levels that may cause equipment damage, electrical shock and/or electrocution if handled incorrectly.

All electrical circuits associated with Auxiliary Power Units (APUs), shore power, and inverters should be considered high voltage.

Shoreline Electrical Connection

Your apparatus may include an electrical connection to keep the batteries charged while in the station (commonly referred to as a shoreline connection). A compatible power cable is required to make this connection. It is essential that the source of power is the correct electrical phase, polarity, voltage and current capacity. Refer to the placard near the shoreline connection. Only connect the vehicle to a trusted source that you are sure meets these criteria and NEC and local electrical codes.

Wire Rope Inspection or Maintenance

Your apparatus may use wire rope (cable) that needs to be inspected or serviced. Wire rope, through use, can develop “barbs” which can slice skin. It is extremely important to wear protective gloves while handling wire rope. Avoid loose fitting clothes or anything that could become entangled in the wire rope and other moving parts.

Air Conditioning Refrigerant

Use only refrigerants approved for use in air conditioning systems. Some unapproved refrigerants are flammable and can explode, causing injury to personnel. The air conditioning system contains refrigerant under high pressure. To avoid risk of personal injury or damage to the system, only a certified technician should add refrigerant or perform any repair requiring lines to be disconnected.

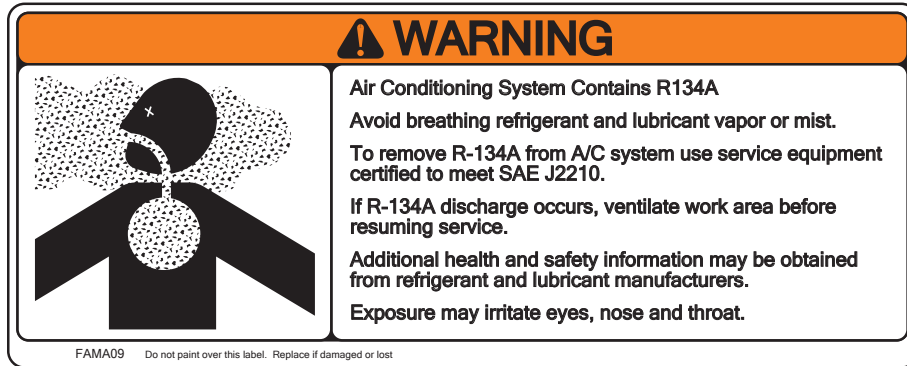

Towing Your Apparatus

Only allow your apparatus to be towed by a trained, authorized, and experienced tow operator. Tow only with a sufficiently capable heavy duty wrecker. To prevent damage, injury or death,

- Do not lift apparatus from front bumper or front bumper extensions.
- Only lift apparatus from front axle, front suspension, or chassis frame rail or frame rail crossmember that is bolted directly to the frame.
- Disconnect the driveline or remove the axle shafts from the drive wheels.
- The wrecker operator is responsible for following all warnings associated with equipment, controls, and operation.

No-Spin or Locking Differentials

If your apparatus is equipped with a No-Spin or Locking Differential be sure to distribute the load evenly side-to-side; do not exceed the vehicle's rated payload capacity; keep the diameter of the tires equal. Failure to observe these measures can create a difference in individual wheel speeds which can cause the No-Spin or locking differential to deliver power to only one side of the vehicle and thus cause steering problems.

Turn the engine off and raise all driving wheels of a No Spin or locking differential equipped axle when changing tires to prevent the vehicle from moving. Axles equipped with No-Spin or locking differentials deliver power to both wheels - even when only one wheel is on the ground.

CONTROLS & COMPONENTS DESCRIPTIONS

OVERVIEW

This section of the Operator's Manual describes the controls you will need to be familiar with to safely and properly operate and service your apparatus chassis. The Operating Procedures Section of this manual will go on to explain how to use these controls for safe and proper operations. As fire apparatus are by nature customized to the needs of particular departments, your apparatus controls may have certain variations from the descriptions in this section. If you need assistance or further explanation, contact your department safety or training officer.

CAB TILT CONTROLS

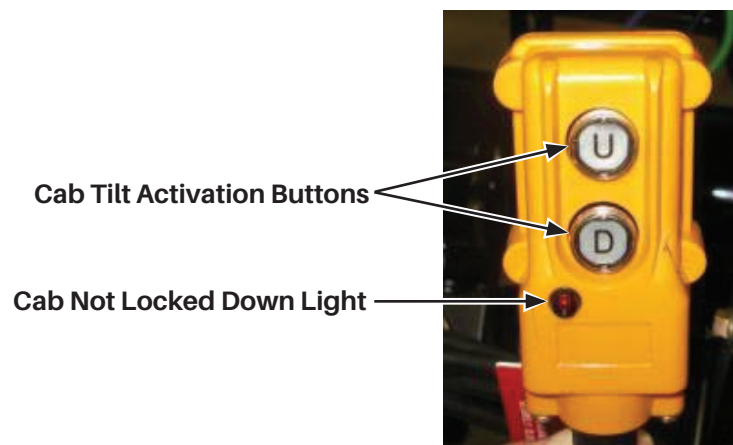

Figure 3-1. Cab Tilt Pendant Control

Cab Tilt Pendant Control - Wired remote control to operate the cab tilt system.

1. **Two momentary buttons** - U for Up, D for Down. Must be held while cab is in motion.
2. **Unlock Light** - The red light on the pendant will illuminate any time the tilt system is energized by the "D" button until the cab locks have fully engaged.



Figure 3-2. Lowering Cab - Safety Support Mechanism Release Cable

CONTROLS & COMPONENTS DESCRIPTIONS

Safety Support Mechanism Release Cable - Pulling the cable toward the rear of the apparatus releases the support channel on the cab tilt lift cylinder to allow the cab to lower.

POWER WINDOWS (IF EQUIPPED)

The power window switch is located on the interior door panel of each door. Power windows will only work when the master switch is in the "on" position.



Figure 3-3. Power Windows (If Equipped)

DOOR LOCKS

Manual Door Locks

Door lock switch is located near the door release handle. Turn the red switch clockwise to lock.



Figure 3-4. Manual Door Lock

Power Door Locks

Three position switch located with the window control switches. Push top of switch to unlock, push bottom of switch to lock.



Exterior Power Door Lock Key Pad



Interior Power Door Lock Switches

Figure 3-5. Power Door Locks

Door Lock Remote Control



Figure 3-6. Key Fob (If Equipped)

CAB DOME LAMPS

There is a clear light above each door, which activates when the door is opened. This same light may be used when the door is closed by pressing the switch on the light housing. The red dome light typically will be switched on manually by the switch.

SEAT CONTROLS

The controls for adjustable seats are located at the front of the seat frame below the cushion. Seat adjustments are activated by a mechanical lever, an air pressure switch, or an electronic switch depending upon the options selected. The available seat comfort adjustments for fore and aft, raise and lower, back angle adjustment, leg angle adjustment, and lumbar are determined by the ordered option.

CAUTION

Occupants must be seated and seat belts must be securely fastened when vehicle is in motion.

CONTROLS & COMPONENTS DESCRIPTIONS

DOOR AJAR SYSTEM (IF EQUIPPED)

Whenever a cab or compartment door is open and the parking brake is not engaged, a red light flashes to alert of the condition. The light is located overhead between the driver and passenger.



DO NOT MOVE VEHICLE WHEN LIGHT IS ON. If the red Door Ajar light illuminates while driving, the vehicle must be stopped to check for an open door.

STEERING SYSTEM AND COLUMN CONTROLS

Tilt & Telescoping Steering Column

To provide optimum steering wheel position, the steering column is fully adjustable. Also featured on the column are the horn button, directional switch, high beam switch, and four-way flasher switch.

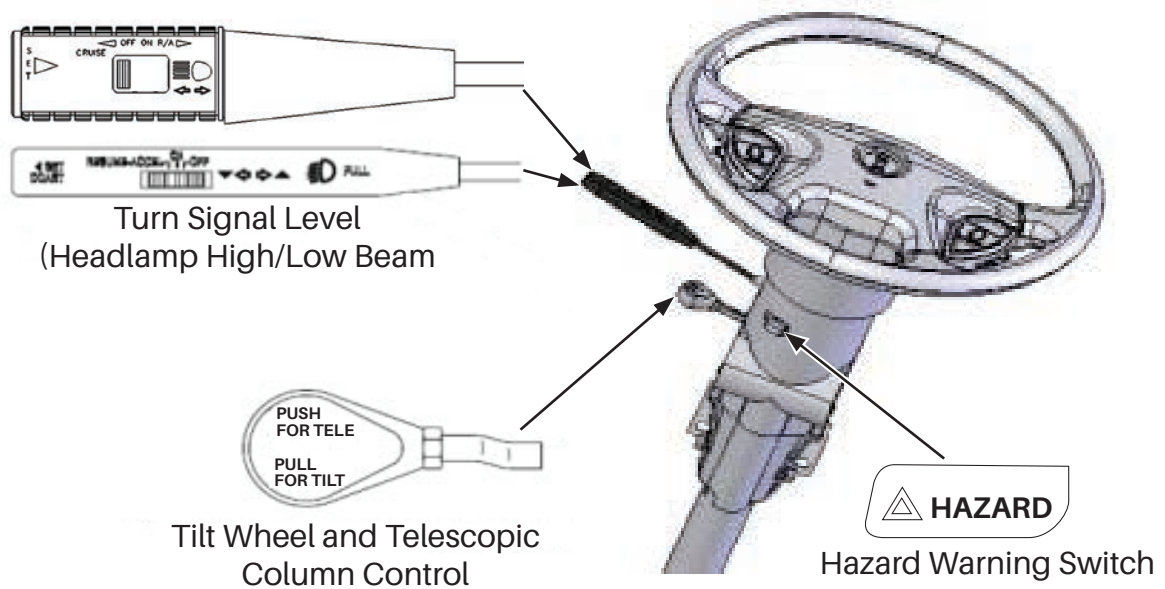

Figure 3-7. Tilt & Telescoping Steering Column

To Telescope Wheel

Push down on the lever located below the directional switch on the left side of the column while simultaneously raising or lowering the wheel to the desired position.

To Tilt Wheel

Pull up on the lever located below the directional switch on the left side of the column while simultaneously tilting the wheel to the desired position.

Horn Button

The horn button is in the hub of the steering wheel and activated by depressing the button.

Turn Signal Lever and High Beam Switch

This is located on the left side of the steering column below the wheel. It operates the turn signals and is self-canceling type. This lever also controls the headlight high beam function. To turn the high beams on or off, raise this lever until it clicks into position and release. An instrument panel indicator blue light will illuminate when you have selected high beam.

Hazard Four Way Flashers

This switch is located under the column towards the left side. Pull the slide switch out to turn on and push in to turn off.

Column Mounted Cruise Control (If Equipped)

Cruise control is integrated into the turn signal lever on the steering column. Refer to the illustration above to identify their location.



DO NOT use the cruise control function during inclement weather, adverse road conditions, or in heavy traffic.

The cruise functions are cancelled when the brake pedal is applied.

Cruise control functions operate as follows:

Table 3-1: Cruise Control Functions

Press and Release:	To:
'ON'	Activate the cruise system.
'OFF'	Deactivate the cruise system.
'SET/COAST'	Set: Sets cruise speed at the speed the vehicle is traveling when applied. Coast: Decreases the set cruise speed when control is pressed and held.
'RES/ACCEL'	Res: Resets to the previously set cruise speed if cruise has been cancelled and still 'on.' Accel: Increases set cruise speed when control is pressed and held.

Turn Signal Lever and High Beam Switch

This is located on the left side of the steering column below the wheel. It operates the turn signals and is self-canceling type. This lever also controls the headlight high beam function. To turn the high beams on or off, raise this lever until it clicks into position and release. An instrument panel indicator blue light will illuminate when you have selected high beam.

Hazard Four Way Flashers

This switch is located under the column towards the left side. Pull the slide switch out to turn on and push in to turn off.

CONTROLS & COMPONENTS DESCRIPTIONS

OPTIONAL STEERING WHEEL CONTROLS

Refer to [Figure 3-7](#).

NOTICE

Do not push buttons on the steering wheel while turning the ignition switch from the off to the on position. If button is pushed, recycle ignition without pressing buttons.

Fog Lights

When the fog lights are 'OFF' and this button is pressed, the fog lights will turn 'ON'. The opposite occurs if the button is pressed again.



Wiper Control Functions

The four buttons on the lower left side are the wiper control buttons.



Wiper Variable Display

If the button is pressed one time, and not pressed again within 30 seconds, the wipers will 'pulse' – completing only one cycle. If the button is pressed a second time within 30 seconds, an ongoing delay wipe function will occur. The delayed time interval between wipe cycles will equal the time interval between when the button was pressed the first and second time. Initiation of any other wiper function will override the variable setting.



Wiper Wash

Press to pump and squirt fluid onto the windshield. If pressed when the wipers are off, the wipers will complete approximately 3 cycles and then turn off again.



Wiper High/Low

Press to activate wipers. When initially turned on, the wipers will be at low speed. Pressing the button a second time shifts the wipers to high speed. Every time the button is pressed, the wipers alternate between low and high speed.



Air Horn

Press to activate air horn.



Auxiliary Engine Brake Control Functions

The four buttons on the lower right side are the auxiliary engine brake control buttons. They are as follows: Engine brake low, on/off switch, engine brake medium, and engine brake high.



CONTROLS & COMPONENTS DESCRIPTIONS

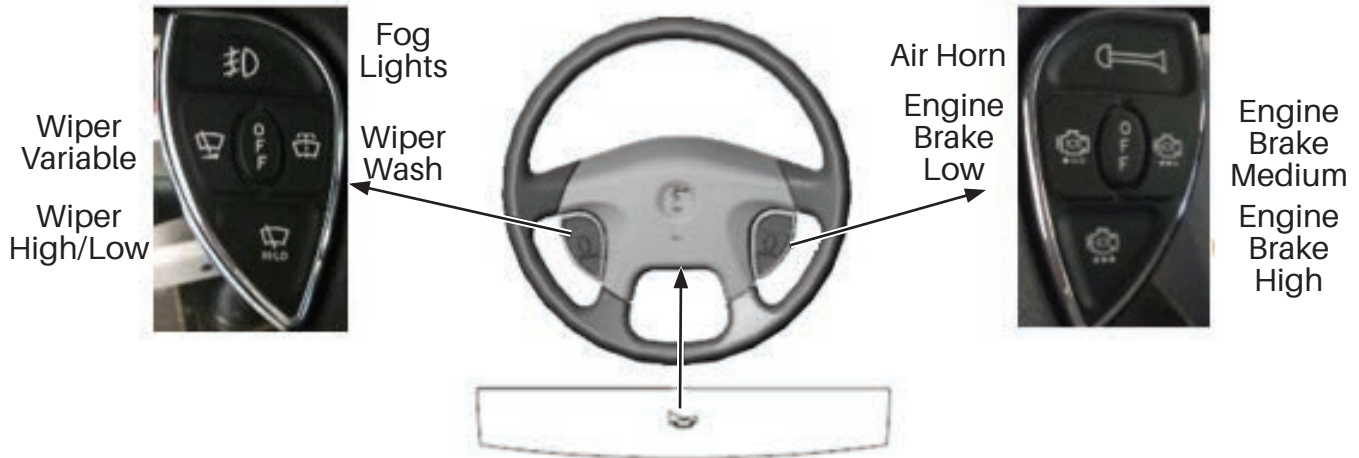

Figure 3-8. Steering Wheel and Center Controls

GRAPHICAL INSTRUMENT CLUSTER

Driving Screen



Figure 3-9. Driving Screen

1. Tachometer
2. Transmission Range Selection
3. Engine Hour Meter
4. Odometer

5. Warning Telltales
6. Speedometer
7. Numeric Speed Indicator
8. Air Pressure – System 2 (Front)
9. Air Pressure – System 1 (Rear)
10. Battery Voltage
11. Right Turn Signal Indicator
12. Diesel Exhaust Fluid Level
13. Menu Selection & Message Area
14. Fuel Level
15. Left Turn Signal Indicator
16. Engine Coolant Temperature
17. Transmission Temperature
18. Engine Oil Pressure

Joystick/Rotary Control

The Joystick/Rotary control is used to navigate the Menu Selection & Message Area and to switch screens.



Figure 3-10. Joystick/Rotary Control

- **Rotate Left/Rotate Right** - When activated, menu items move through the blue rectangle.
- **Joystick Press and Release** - When activated, the menu item in the blue rectangle is opened.
- **Joystick Press and Hold** - Activate to silence audible alarms.
- **Joystick Up** - When activated, scrolls through driving and other navigation screens.
- **Joystick Down** - When activated display changes to the Backup Camera screen (if equipped)/Menu Navigation
- **Joystick Left** - When activated with the Camera Screen on selects the Driver Side Camera (if equipped)/Menu Navigation.

CONTROLS & COMPONENTS DESCRIPTIONS

- **Joystick Right** – When activated with the Camera Screen on selects the Passenger Side Camera (if equipped)/Menu Navigation.

Menus

Menu Selection and Message Area

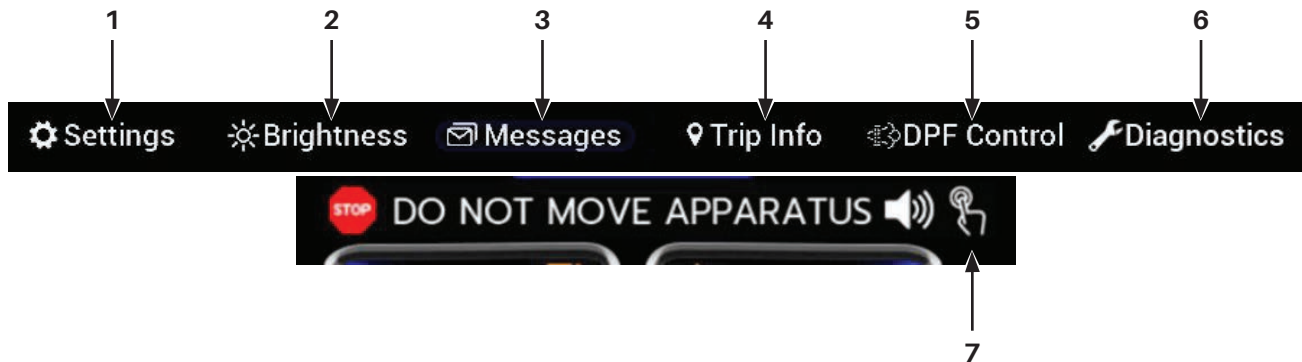

Figure 3-11. Menu Selection and Message Center

1. **Settings** – Press and release to go to the Settings Menu.
2. **Brightness** – Press and release to adjust the display brightness for the current mode (DAY or NIGHT).
3. **Messages** – Press and release to access message.
4. **Trip Info** – Press and release to access the odometer display: ODO, TRIP A, TRIP B.
5. **DPF Control** – Press and release to access the Diesel Particulate Filter Menu. Initiate manual DPF regeneration or inhibit DPF regeneration.
6. **Diagnostics** - Press and release to go to the Diagnostic Menus.
7. **Message Area** – Press and release to display all active warning messages. Indicates audio warning and silence.

Settings Menu

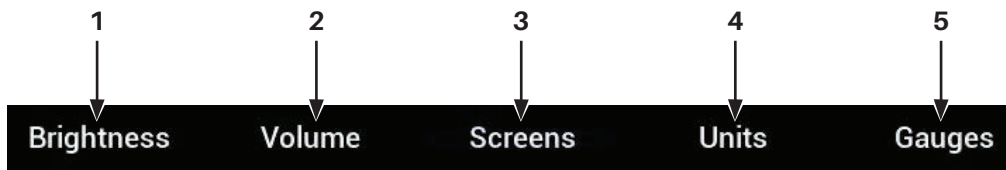

Figure 3-12. Settings Menu

1. **Brightness** – Adjust brightness settings for both DAY and NIGHT mode.
2. **Volume** – Adjust audio alarm volume.
3. **Screens** – Control auto-switching of camera screens and pump screen, if equipped.
4. **Units** – Switch between standard and metric units for distance, temperatures, and pressures.

5. **Gauges** – Adjust location of optional gauges, if equipped.

Diagnostics Menu

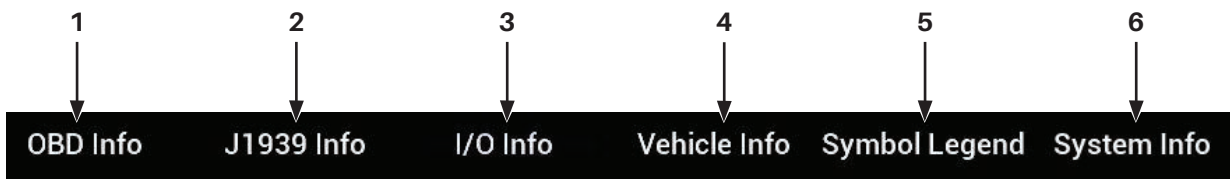

Figure 3-13. Diagnostics Menu

1. **OBD Info** - Displays all active On-Board Diagnostic faults, including the system reporting the fault, the suspect parameter number (SPN), and the failure mode identifier (FMI).
2. **J1939 Info** - Displays a list of all current message data on the J1939 databus.
3. **I/O INFO** - Displays the status of all wired inputs and outputs of the display, including joystick/rotary control diagnostics.
4. **Vehicle Info** - Displays broadcast chassis information, including the Vehicle Identification Number (VIN).
5. **Symbol Legend** - Displays a glossary of all symbols and icons used.
6. **System Info** - Displays hardware and software version information.

Diesel Particulate Filter (DPF) Menu

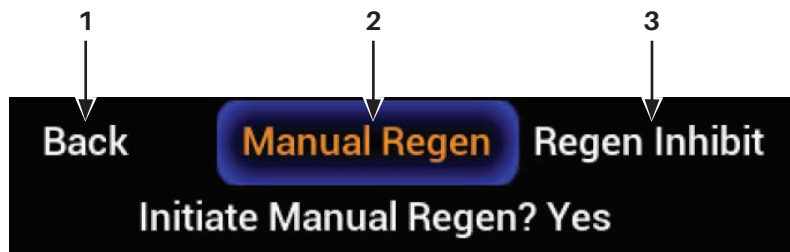

Figure 3-14. Diesel Particulate Filter (DPF) Menu

1. **Back** – Press and release to return to Menu Selection.
2. **Manual Regen** – Press and release to initiate diesel particulate filter regeneration.
3. **Regen Inhibit** – Press and release to postpone automatic regeneration of the diesel particulate filter regeneration. The Regen Inhibit will be active until cancelled by the operator or until the ignition switch is turned off and back on again.

CONTROLS & COMPONENTS DESCRIPTIONS

Camera Screen/Hour Meters (Optional)



Figure 3-15. Camera Screen

The Graphical Instrument Cluster may display video from on board cameras. This includes a backup camera, driver and passenger cameras, or from a 360° camera system. The Graphical Instrument Cluster will automatically switch to the Camera Screen and display the appropriate camera when -

- **The Transmission is in reverse** - Backup Camera.
- **The Turn Signal is activated** - Left Turn/Driver Side Camera, Right Turn/Passenger Side Camera.

Auxiliary Gauges (Optional)

The Graphical Instrument Cluster supports optional auxiliary gauges and hour meters.



Figure 3-16. Auxiliary Air Pressure



Figure 3-17. Brake Application Pressure

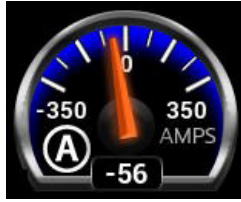

Figure 3-18. Amp Meter



Figure 3-19. Hour Meters

1. Pump Hour Meter
2. Aerial Hour Meter
3. PTO Hour Meter

TRADITIONAL INSTRUMENT CLUSTER

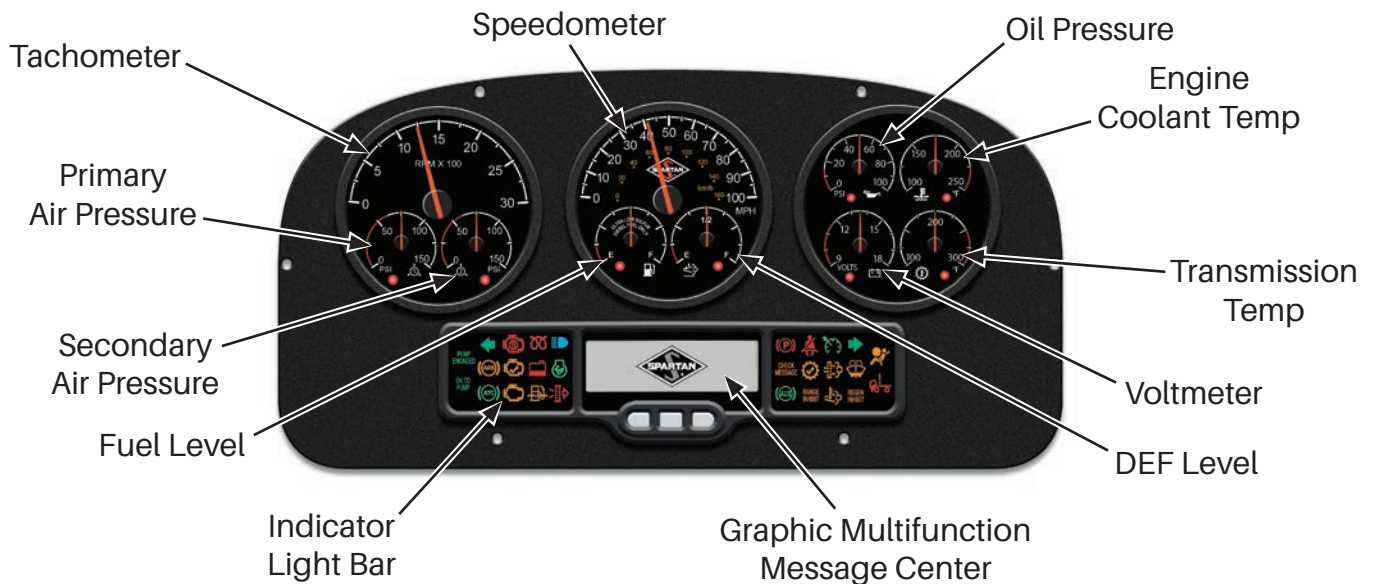

Figure 3-20. Traditional Instrument Cluster

CONTROLS & COMPONENTS DESCRIPTIONS

Diagnostics

Diagnostics screens can be accessed when the vehicle speed is equivalent to zero (0) mph, park brake engaged, transmission in neutral and the display in the normal operating screen. Available diagnostics are Instrument, Engine, Transmission, and ABS. Refer to the instrumentation user manual for more information.

For detailed information, refer to the E-One Instrumentation User's Guide located in the manufacturer's literature.

For detailed information regarding vehicle emission indicators, refer to the label located above the sun visor.

Diesel Exhaust Fluid (If Equipped)

The chart below explains each of the indicator levels you might see on the DEF indicator.

Table 3-2: Diesel Exhaust Fluid (DEF) (If Equipped)

Diesel Exhaust Fluid Level	LCD Message	DEF Lamp*	Check Engine Lamp	Audible Alarm	Operator Action Required
Above 15%	None	Off	Off	None	None
15%	Low Diesel Exhaust Fluid	Solid	Off	Chime (5 sec)	Fill DEF tank to a minimum of 2.5% above initial warning level
10%	Low Diesel Exhaust Fluid - Urgent	Flash-ing	Off	Steady tone, acknowledgeable	Fill DEF tank to a minimum of 2.5% above urgent warning level.
5%	Low Diesel Exhaust Fluid - Critical	Flash-ing	Solid	Steady tone, acknowledgeable	Fill DEF tank to a minimum of 2.5% above critical warning level.
0%	Low Diesel Exhaust Fluid - Critical	Flash-ing	Solid	Steady tone, acknowledgeable	Fill DEF tank to a minimum of 4.5% and allow DEF system to prime.

* DEF Lamp located in gauge near DEF needle

- Low Diesel Exhaust Fluid will not result in engine performance de-rate or vehicle speed restrictions in emergency vehicles.
- Filling the DEF tank with improper Diesel Exhaust Fluid will result in an engine fault and active check engine lamp. Improper DEF fluid, however, will not result in engine performance de-rate or vehicle speed restrictions in emergency vehicles.

NOTICE

Do not handle electrical components after having handled diesel exhaust fluid.

Electronic Fluid Checks

The Electronic Fluid Checks message display is located as a selectable option within the message center in the dash. When the master switch is "ON" and the ignition switch is initially turned "ON", fluid levels for the power steering, windshield wiper fluid, engine coolant, and engine oil are being monitored. The transmission fluid check requires the transmission fluid to reach a certain temperature, reference the transmission manual for more information. The engine oil and power steering fluid levels cannot be accurately read while the engine is running. The display will signal a check fluid message, all levels normal or "NA". If the signal indicates, "check", refer to the applicable manual fluid check procedure for fluid fill level.

ENGINE STARTING/STOPPING

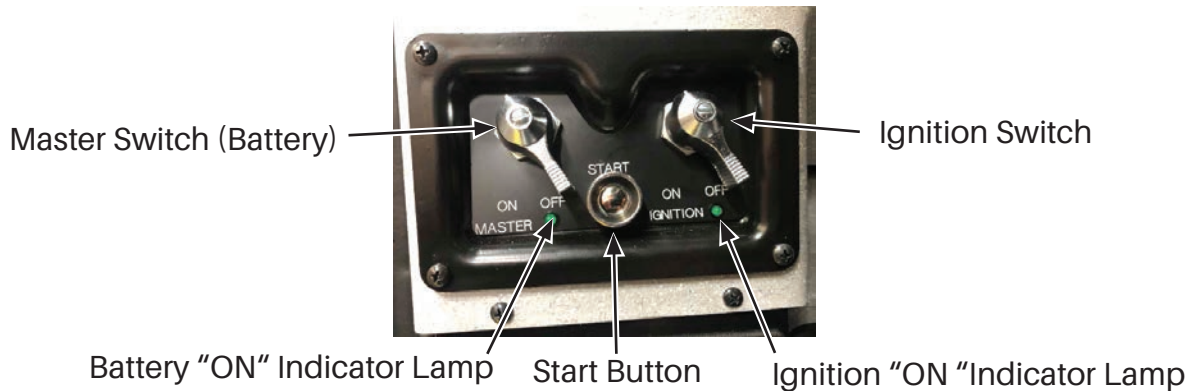

Figure 3-21. Starting/Stopping Panel

NOTICE

Start button should not be depressed until the instrumentation cluster completes its self test/ initialization process.

It is important to idle an engine for 3 to 5 minutes before shutting down. This allows the lubricating oil and coolant to carry heat away from the turbo charger bearings and cylinder walls, thus allowing gradual and uniform cooling.

Master Switch

This switch energizes the electrical system from the batteries. A green LED indicates switch is in the on position.

Ignition Switch

Switches power to the starter button and accessories; use to shut down the engine when turned to the off position. A green LED indicates switch is in the on position.

Engine Start Button

Depress button to engage the cranking motor that cranks the engine if the transmission is in neutral.

CONTROLS & COMPONENTS DESCRIPTIONS

NOTICE

Engine start button should not be depressed until the instrument cluster complete its self test/initialization pro

DRIVER'S CONSOLE

Switch positions and console layouts may vary based on console design and customer requested options. Not all controls described in this section are included with every product. Some controls are optional equipment. For supplemental operating information relative to the completed vehicle, refer to the respective final stage manufacturer's literature and component manufacturer's literature.



Figure 3-22. Driver's Console

Heating and Air Conditioning Controls

Refer to the Heating and Air Conditioning Controls section. These are present with a headliner-mounted evaporator only.

Instrument Illumination Dimmer

Push rocker to brighten/dim instrument illumination.

Wiper/Washer Control

Push lever down to turn on or shut off wipers. Move lever up for high speed or down for intermittent feature. Push lower button for wash cycle. The washer fluid tank fill is located in the driver's step or behind the grille.

Headlight Switch

Push rocker to first position for parking lights.

Push rocker to the second position for headlights.

Auxiliary Brake On/Off Switch (If Equipped)

The auxiliary brake **must** be turned off while driving in wet or slippery conditions. It **must** be used during normal driving conditions as stated in the manufacturer guidelines for the secondary braking device.

Electric Remote Mirror Switch (If Equipped)

The electric remote mirror switches adjust the mirror flat areas to the desired position by using the left or right switch.

MAIN CONSOLE

Master Warning Switch

The master warning provides power to the other warning light switches on the rocker switch console.

Light Bar (If Equipped)

Controls operation of the light bar located on the cab roof; zone "A" upper.

Warning Front (If Equipped)

Controls operation of the warning lights, generally located above or below the headlights; zone "A" lower.

Warning Side (If Equipped)

Controls operation of the warning lights located in the sides of the front bumper or the sides of the cab/body; zone "B" and zone "D".

Warning Rear (If Equipped)

Controls operation of the warning lights located at the rear of the body; zone "C" upper and lower.

Headlight Flasher (If Equipped)

When in response mode, controls the flashing of only the high beams. High beams will not flash when the high beam switch is in the on position.

Air Filter Restriction Indicator

A vacuum transducer attached to the clean airside of the air filter indicates restriction and the air filter requires servicing.

NOTICE

Replace the filter when lamp is illuminated.

CONTROLS & COMPONENTS DESCRIPTIONS

Fuel Priming Pump (If Equipped)

An optional electric fuel priming pump can be mounted in the frame or on a cross member over the rear fuel tank. The fuel primer is activated by a momentary switch and is for priming the fuel filters or the fuel system in the event the tank has been run out of fuel.

Many engines are self-priming and **do not** require the optional electric fuel pump. Reference Engine Manufacturer's Manual.

Wait-To-Start Lamp (If Equipped)

Your vehicle may be equipped with a wait-to-start lamp. The engine ECU checks the intake manifold temperature to determine how long to energize the air heater before extinguishing the pre-heat lamp. (This is for the pre-heat phase).

Water -In -Fuel Lamp (If Equipped)

A sensor located in the fuel filter housing, activates the Water-In-Fuel (WIF) lamp. A WIF lamp illuminates indicating that the filter needs to be drained from the fuel filter assembly.

AUXILIARY BRAKING

The purpose of an auxiliary brake system is to supply additional braking torque to avoid fading of the chassis brakes that result from frequent stopping. This will allow the chassis brakes to be more effective during a braking event and improve brake life. The retarder can be activated by switches fitted to the accelerator and the clutch and by a hand-operated lever mounted to the steering column or the dashboard.

Auxiliary braking systems may be turned on or off by the operator. Some have different braking levels which may be selected by the driver or programmed into the control system.

The auxiliary brake is a vehicle-slowng device only, not a vehicle-stopping device. It therefore is not a substitute for the service braking system. The service brakes must be used to bring the vehicle to a complete stop.



Vehicles equipped with an auxiliary braking device may lose control in wet or slippery road conditions if ABS system is in the failure mode and the braking device is activated. See auxiliary brake manufacturer's manual for safe operating practices.

Variable Geometry Turbocharger (VGT). Exhaust Brake, OR Compression Brake

This is a diesel engine retarder and is power absorbing by exhaust restriction similar to an air compressor or a vacuum pump.

Transmission Output Retarder

The transmission output retarder absorbs horsepower on the driveshaft and slows the vehicle. When using the transmission output retarder, the energy is transferred to heat to be dissipated by the cooling system.

Electric Driveline (Telma) Retarder

A TELMA Electro-magnetic Retarder is an assembly of electromagnetic coils, which when activated by an electrical current, creates eddy (Foucault) currents between two rotors and a stator and retards the movement of the rotor. Fitted into the driveline of a vehicle the Telma retarder acts directly on the driven wheels and reduces the speed of a vehicle. The energy created in the operation of a Telma retarder is converted into heat. Correctly applied, however, this temperature build up will be dissipated through efficient heat sinks on the retarder and no loss of efficiency will occur.

The toggle switch (on/off) located on the switch panel near the headlight switch will enable or disable the Retarder operation. This switch is used to disable the retarder in the event of slippery road surfaces. Indicator lights are provided to show the level a braking provided by the retarder.

CAUTION

The retarder will not work when vehicle speed is below (3) three m.p.h. You must apply the service brakes.

DRIVER ASSIST SYSTEMS

Automatic High Idle

If you have the Class 1 load manager - if the system voltage drops to 12.8 volts for one minute, the automatic high idle system will raise the engine RPMs to increase alternator output. If you have the V-MUX® - if the system voltage drops to 12.5 volts the automatic high idle system will raise the engine RPMs to increase alternator output. The system will only operate with the transmission in neutral, the park brake applied, and the fire pump disengaged. The automatic high idle will stay engaged for a minimum of 10 minutes and until the system, voltage has reached 13.0 volts. Application of the service brake will override the automatic high idle and reset timer.

Anti-lock Braking System (ABS)

This system continuously monitors individual wheel speed. If a wheel lockup condition is sensed, the brake pressure to that wheel will automatically be modulated when brakes are applied to prevent slippage. This allows for better stability of the vehicle during stops by avoiding skidding. The ABS system will enable reduced stopping distances on a variety of road surfaces while maintaining vehicle stability. When the engine is started, the ABS amber warning light illuminates and goes out after system is checked.

If a system failure occurs, only the affected wheel returns to normal braking function while the remaining wheels operate with ABS. Should total failure develop, the vehicle returns to standard braking without losing any of its normal efficiency.

NOTICE

The ABS system is interfaced with the auxiliary braking device circuit. In the event of a wheel slip, the auxiliary braking device is disabled.

With air brake equipped vehicles, it is not advisable to pump the brake pedal. Keep steady pressure on the pedal and modulate intensity as required for safe deceleration.

CONTROLS & COMPONENTS DESCRIPTIONS

Automatic Traction Control System (ATC)

The ATC function is similar to that of a limited slip differential. When wheel spin occurs, braking automatically applies to the spinning drive wheel. Engine speed is also decreased as needed until traction is achieved to move the chassis.

The green low traction indicator light illuminates when wheel slip is detected.

If it is desired to rock the vehicle and ATC has cut the throttle back, depress the mud and snow switch. Once depressed the ATC lamp will flash continuously until the switch is depressed again.

NOTICE

Use reasonable care when depressing the mud and snow switch. When wheel /tire suddenly regains traction, component damage can occur.

Electronic Stability Control (ESC)

The electronic stability control unit is a functional extension of the electronic braking system. It is able to detect any skidding of the vehicle about its vertical axis as well as any rollover tendency. The control unit comprises an angular-speed sensor that measures the vehicle's motion about the vertical axis, caused, for instance, by cornering or by skidding on a slippery road surface. An acceleration sensor measures the vehicle's lateral acceleration. The steering angle sensor, located on the column, measures the steering angle of the wheel. On the basis of lateral acceleration and steering angle, an integrated microcontroller calculates a theoretical angular speed for the stable vehicle condition. The ESC module, which is mounted on the first cross member rear of the transmission, is located in a specific location to get accurate sensor readings; this module must not be moved.

Items below would require recalibration:

- Steering wheel replacement.
- Any maintenance, which involves removing the Steering Angle Sensor (SAS).
- Any maintenance or repair work to the steering gear, linkage, or related component.
- Wheel alignment or wheel track adjustment.

If the tire size is changed then the customer needs to contact E-One to determine if the ESC ECU needs to be changed also, and if the tire size changes and/or the ECU component changes then the ESC needs to be recalibrated.

ENGINE COOLING FAN CLUTCH CONTROL (IF EQUIPPED)

For vehicles equipped with a fan clutch, the fan will engage automatically when engine temperatures demand additional cooling. There are two types of fan clutches:

- **On/Off** - The fan will engage at full speed when additional cooling is required. The fan will remain engaged for a minimum period of time (30 seconds typical) to prevent rapid cycling of the fan.
- **Variable Speed** - The fan will operate at a percentage of full speed up to 100% based on the cooling demands of the engine.

For both types of clutches, the engagement is automatic and requires no user interaction.

Manual Fan Override Control (If Equipped)

Some vehicles are equipped with a manual fan override feature. This function may be activated by a switch on the main control console or by a button on the Vista Multiplex Control Display (if equipped). Activating this function will engage the fan at full speed and override the automatic control of the fan clutch. Turning this feature off will return the fan control to automatic mode.

Fan in Pump Mode (If Equipped)

Some vehicles are configured to engage the fan at full speed whenever the apparatus is in pump mode. For vehicles equipped with the feature, the fan will engage when the "OK to PUMP" or "THROTTLE READY" lamps are active. When placed back in "ROAD" mode, the fan control will return to automatic mode.

Engine Cooling Fan Clutch Diagnostics (Variable Speed Fan Only)

For vehicles equipped with a variable speed fan control system, the following information may be monitored in the LCD Message Center on the main instrument panel. Please refer to the E-One Motors Instrumentation System manual for information on how to monitor available data parameters in the message center.

Actual Fan Speed

Fan Clutch Input Speed

Requested % Fan Speed

Estimated % Fan Speed

In addition, any faults detected with the fan system will result in the LCD message center displaying a "FAN FAULT" message. Please refer to the Fan Clutch Technical Reference manual for further diagnostic and troubleshooting information.

CLASS 1 TOTAL SYSTEM MANGER (IF EQUIPPED)

SEQUENCING: To reduce strain on the chassis' charging system, any loads controlled by the load manager can be programmed to turn on in sequence when the activating switch (either ignition or master warning light switch) is closed. Each load can be assigned to one of eight sequence stages. The loads will sequence off in reverse order.

SHEDDING: To reduce the demand on the chassis' charging system, nonessential loads controlled by the load manager can be programmed to turn off under conditions of extreme electrical load. Eight of the twelve outputs controlled by the load manager can be assigned to shed at one of eight priority levels. The lowest priority loads will begin to shed when the system voltage drops to 12.7 volts, and all loads programmed to shed will turn off after the system voltage drops to 11.0 volts. In order for a load to shed, the system voltage must drop below the shed point voltage for a minimum of one minute. Shed loads will remain off for a minimum of 5 minutes and will not turn on again until the system voltage rises above the unshed point for one minute.

Load shedding is only active with the park brake set (scene mode). Each load controlled by the load manager can be given a shed priority independent of its sequence.

CONTROLS & COMPONENTS DESCRIPTIONS

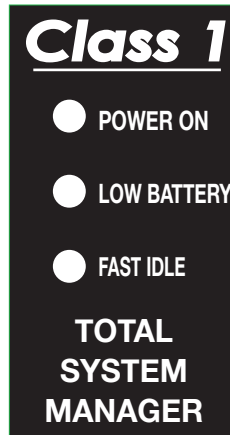

Figure 3-23. System Manager (If Equipped)

Automatic High Idle (If Equipped)

To increase alternator output under conditions of extreme electrical load, the load manager will boost the engine idle speed after the system voltage drops below 12.8 volts for at least one minute. The high idle will remain active for at least 10 minutes and until the system voltage has stabilized above 13.0 volts. Automatic high idle will only be available with the park brake set, transmission in neutral, and when fire pump is disengaged. The automatic high idle function can be deactivated by depressing the brake pedal. Automatic high idle mode is indicated by the "FAST IDLE" light in the load manager display.

Low Voltage Light

The load manager provides a "LOW BATTERY" light in the load manager display and activates the alarm when the system voltage falls below 11.9 volts.

Load Manager Display

The load manager comes standard with a status display that fits conveniently in a standard rocker switch cutout. The display has LED tell tales for "POWER ON", "LOW BATTERY", and "FAST IDLE".

Table 3-3: Operational Data

* SHED POINTS		*UNSHED POINTS	
Level 0	Never Shed	Level 1	11.4
Level 1	11.0 Volts	Level 2	11.6
Level 2	11.4 Volts	Level 3	12.0
Level 3	11.8 Volts	Level 4	12.2
Level 4	12.0 Volts	Level 5	12.4
Level 5	12.2 Volts	Level 6	12.6
Level 6	12.4 Volts	Level 7	12.8
Level 7	12.6 Volts	Level 8	13.0
Level 8	12.7 Volts		

Sequencing

Electrical loads will turn on sequentially in priority order from 1 to 8 when their respective switch is activated (either ignition or warning master) and the vehicle is operated in the mode selected for that output (response and/or scene). Loads will sequence off in reverse order. Priority zero loads will be sequenced on and off, but will not shed.

Shedding

Electrical loads will be turned off (shed) when the system voltage drops to the shed point for a minimum of one minute (this prevents load shedding due to momentary system power loading such as high current start-up devices). Once shed, loads will remain off for a minimum of five minutes and until the unshed voltage is achieved for a minimum of one minute. Loads will only shed if the Parking Brake is set and the Load Manage Enable input is "grounded".

NOTICE

SHED POINT is the voltage that will cause a load to be turned off if the system voltage drops to this point.

UNSHED POINT is the voltage that must be achieved before a load is turned back on once it has been shed.

High (Fast) Idle

A High Idle output is activated whenever the system voltage is reduced to 12.8 VDC for at least one minute. The high idle output will remain ON for a minimum of 10 minutes and until 13.0 VDC is achieved. The high idle output is dependent on the Parking Brake and Load Manage Enable inputs.

NOTICE

1: This output should only be used as part of a fast idle control system when the proper safety interlocks are present.

2: The FAST IDLE output will turn off immediately when the Load Manage Enable input is removed from ground potential.

Low Voltage Alarm

Whenever the system voltage drops below 11.9 VDC, a low voltage alarm output (ground) is activated. This complies with the **National Fire Protection Association NFPA® 1900** requirements.

Switch Sources

IGNITION: Loads will sequence on when the vehicle ignition switch is turned ON.

MASTER WARNING: Loads will sequence on when the master warning switch is turned ON.

EACH LOAD CAN BE PROGRAMMED FOR ACTIVATION BY EITHER SOURCE.

CONTROLS & COMPONENTS DESCRIPTIONS

User Set Point/Variable Trip

This is the user definable output. The user has the option of selecting a "trip" voltage between 10.5 and 15.0 VDC. If the trip point is set to 13.8V or above, the output acts as an over voltage indicator and will "energize" when the voltage drops to the set point.

Auxiliary Battery Monitoring

Terminal #23 can be used to monitor an auxiliary battery. There should be no connection to this terminal if a remote battery is not monitored. If the auxiliary battery voltage drops below 11.9 volts, it will activate the auxiliary battery low output.

Output Modes

RESPONSE MODE: Output is ON only when the Park Brake is NOT set.

SCENE MODE: Output is ON only when the Park Brake IS set.

BOTH: Output is ON in both Response and Scene Mode.

EACH LOAD CAN BE PROGRAMMED FOR RESPONSE MODE, SCENE MODE OR BOTH.

Operating Voltage

7.5 TO 20 Volts D.C.

Outputs

High Side Drivers: Vmain at 0.5 amp. (source).

Low Side Drivers: Ground at 0.5 amp. (sink).

Transient Suppression

Outputs are protected against thermal overload, direct shorts and transient spikes from -50 to +60 volts D.C.

Override

Located on the PC Board of the load manager. Outputs 1 through 12 are forced on when the override switch is active.

NOTICE

Twelve (12) outputs can be programmed by the user to be activated by the ignition or Master Switch tied to Scene Mode, Response Mode or Both, and assigned a Specific Priority Level. More than one output load can be set to the same Priority Level.

MULTIPLEX CONTROL VISTA DISPLAY (IF EQUIPPED)

Certain chassis cabs may be equipped with a Weldon Multiplex System, or V-Mux®, in conjunction with conventional wiring controls. The driver and/or operator interface for this system consists of one or more visual displays known as "Vista(s)" located in or near the frontal switch panel area.

Vista IV Standard Controls



Figure 3-24. Vista IV Standard Controls

Vista IV Control Interface Features

Clock

Time is displayed in the upper right corner of the screen.

Message Bar

Important messages that need acknowledgement by the user are displayed at the top of the screen in the order that they are received. Refer to Message Acknowledge button section.

Graphics Area

The center area of the display may be programmed to show general information such as high idle status, body builder info, or illustrative view of the chassis to indicate when a door is ajar.

Seat Belt Indicator

The seat belt indicator will be displayed if the Vehicle Data Recorder (VDR) identifies a seat belt error. This will indicate that a seat is occupied but the occupant is unbuckled or a buckled seat is unoccupied.

Climate Control Indicator

If HVAC is controlled by the V-Mux® system, then the climate control indicator displays the state of HVAC system.

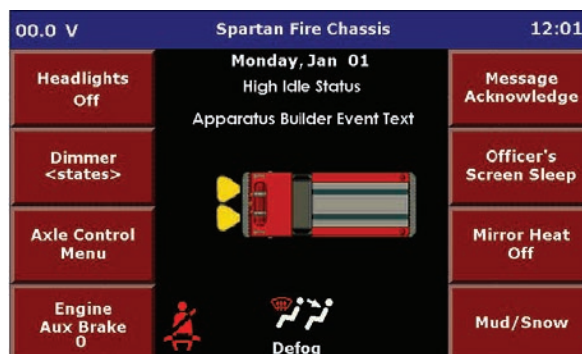

Figure 3-25. Vista IV Interface Features

CONTROLS & COMPONENTS DESCRIPTIONS

Vista IV Display Control Buttons With Heat A/C (Items 1-7)

There are seven “soft touch” menu option buttons on the lower panel of the Vista display housing. An indicator light above each button illuminates when the function is activated by depressing the corresponding button. The red “E-Master” (1) button and the green “High Idle” (7) button are toggle controls that activate/deactivate the function when depressed. Buttons 2 - 5 allow instant access to all other Main Menus. Button 6 is for HVAC.



Figure 3-26. Vista IV Display Control Buttons with Heat A/C

1. **E-Master Button** - The red ON/OFF Control for the Master Warning Lights. It toggles all warning lights on and off.
2. **Warning Light Menu Button** - Accesses the Warning Light Menu where individual warning light installations can be turned on and off.
3. **Home Menu Button** - When the chassis is first powered up, the Vista displays the Home Menu. Typically, functions that are most important to the driver will be located here. The home button allows return from other selected menus.
4. **Secondary Menu Button** - The Secondary Menu is where additional lower priority operator controls may be located.
5. **System Info Menu Button** - Pressing the System Info button accesses the main System Info Menu. Refer to System Info section.
6. **Heat A/C Menu Button** - If equipped with a single overhead HVAC system, the HVAC button accesses the main HVAC menu. If equipped with a dual overhead HVAC system, the HVAC button toggles through the Climate Control Modes.
7. **High Idle Menu Button** - The green high idle button is for manual activation/deactivation of the high idle control.

To activate high idle, the transmission **must** be shifted into neutral range, the parking brake set and the fire pump disengaged.

To deactivate the manual high idle the operator may press the manual high idle button or release the parking brake.

Main display will indicate when high idle is Disabled, Enabled, or Active.

NOTICE

Auto high idle (a standard feature) will become enabled when system voltage drops below 12.5 volts. It will automatically disable when system voltage obtains 13.0 volts. Auto high idle can be manually circumvented by depressing and holding the service brake pedal or by release of the park brake.

Vista IV Display Control Buttons Without Heat A/C (Items 1-7)

There are seven “soft touch” menu option buttons on the lower panel of the Vista display housing. An indicator light above each button illuminates when the function is activated by depressing the corresponding button. The red “E-Master” (1) button and the green “High Idle” (7) button are toggle controls that activate/deactivate the function when depressed. Buttons 2 - 6 allow instant access to all other Main Menus.



Figure 3-27. Vista IV Display Control Buttons without Heat A/C

1. **E-Master Button** - The red ON/OFF Control for the Master Warning Lights. It toggles all warning lights on and off.
2. **Warning Light Menu Button** - Accesses the Warning Light Menu where individual warning light installations can be turned on and off.
3. **Home Menu Button** - When the chassis is first powered up, the Vista displays the Home Menu. Typically, functions that are most important to the driver will be located here. The home button allows return from other selected menus.
4. **Secondary Menu Button** - The Secondary Menu is where additional lower priority operator controls may be located.
5. **System Info Menu Button** - Pressing the System Info button accesses the main System Info Menu. - Refer to System Info section.
6. **System Info. 2 Menu Button** - Pressing the System Info 2 button accesses the diagnostic menu.
7. **High Idle Menu Button** - The green high idle button is for manual activation/deactivation of the high idle control.

To activate high idle, the transmission **must** be shifted into neutral range, the parking brake set and the fire pump disengaged.

To deactivate the manual high idle the operator may press the manual high idle button or release the parking brake.

Main display will indicate when high idle is Disabled, Enabled, or Active.

NOTICE

Auto high idle (a standard feature) will become enabled when system voltage drops below 12.5 volts. It will automatically disable when system voltage obtains 13.0 volts. Auto high idle can be manually circumvented by depressing and holding the service brake pedal or by release of the park brake.

Multi-Function Buttons (Items 8)

There are four multi-function buttons (Items 8) on each side of the Vista display. The active menu determines the function of each button.



Figure 3-28. Multi-Function Buttons

Headlights

Toggles through and displays states of Marker lights, Low Beam, and High Beam headlights.

Dimmer

Controls Vista and soft touch button backlighting. Toggles through MAX, NORMAL, DIM, and NIGHT modes with 25% approximate difference in brightness between levels. Also provides control over gauge and dash backlighting when marker lights are active.

Secondary (Aux) Braking Devices - (If Equipped)

Provides control over and indicates status of Secondary Braking Devices.

Message Acknowledge

When depressed this button clears the current message in the Message Bar and displays the next message, if any.

Additional Driver Functions - (If Equipped)

Items such as Tire Chains, Automotive Traction Control (ATC, Mud/Snow), and PTO On/Off controls are commonly located in remaining positions.

Secondary Menu

Additional functions (If equipped) requiring operator interface.



Figure 3-29. Secondary Menu

Warning Light Menu

Allows individual control over specific Warning Light installations.

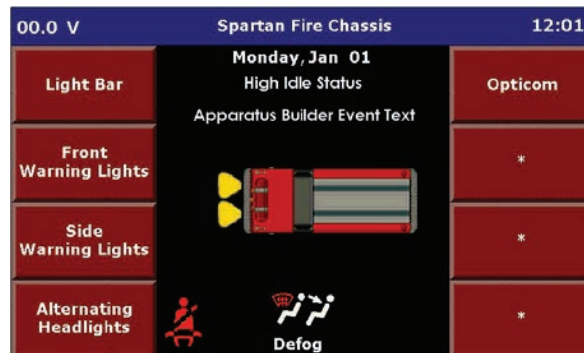

Figure 3-30. Warning Light Menu

System Info Menu

Provides access to sub-menus containing Chassis, Engine and Transmission information, Maintenance Schedule, Date/Time adjustment, and diagnostic menus.

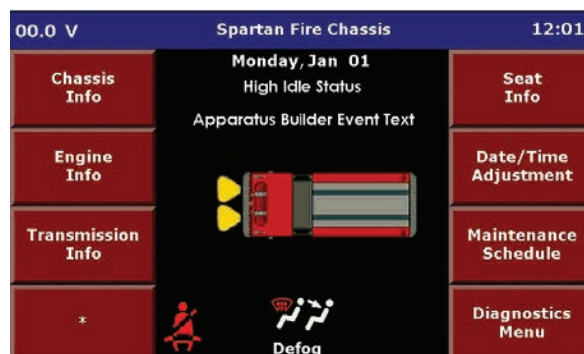

Figure 3-31. System Info Menu

CONTROLS & COMPONENTS DESCRIPTIONS

Chassis Info

Chassis Info displays the Sales Order information, Vehicle Identification Number (VIN), paint numbers, and programming template revision level.

Engine Info

Engine Info displays the engine type, serial number, fluid fill information, and replacement engine filter part numbers.

Transmission Info

Transmission Info displays the transmission type; serial number, fluid fill information, and replacement transmission filter part number.

Seat Info

Provides a link to the Seat Info screen. The Seat Info screen displays all seats and indicates if the seat is occupied and properly buckled.

Date/Time Adjustment

Access to Date/Time adjustment sub-menu.

Maintenance Schedule

Provides important increments for scheduled maintenance.

Diagnostics Menu

Provides a link to the Diagnostics Menu.

Diagnostics Menu

Provides access to Diagnostics sub-menus. Further links to operational and diagnostic menus are provided here. Gauge Diagnostics (a text only screen) details dash mounted Gauge settings and diagnostic procedures.



Figure 3-32. Diagnostics Menu

Pump Mode Info - (If Equipped)

Provides operational information governing pump status. This screen will automatically display when the operator shifts into Pump Mode. If desired, screen can be disabled via "Auto" override button in bottom right corner.

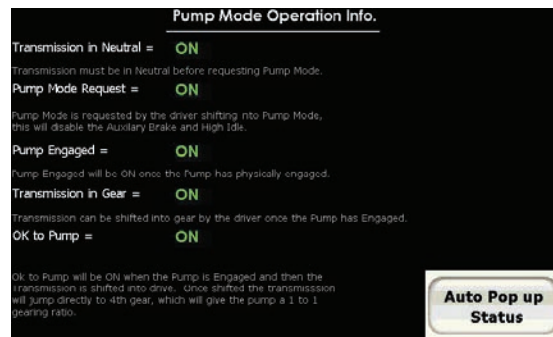

Figure 3-33. Pump Mode Info - (If Equipped)

HVAC Diagnostics For Dual Overhead System

Provides detailed operational status of HVAC system inputs and outputs to aide in troubleshoot and diagnostics. Refer to Climate Control Menu section.

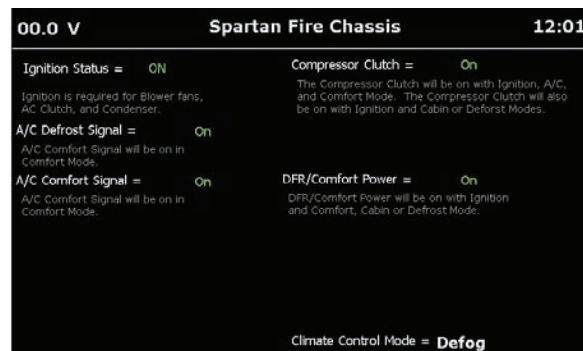

Figure 3-34. HVAC Diagnostics for Dual Overhead System

HVAC Diagnostics For Single Overhead System

Provides detailed operational status of HVAC system. A secondary means of Climate Mode selection is available to aid in trouble-shooting and diagnosis. Refer to Climate Control Menu section.



Figure 3-35. HVAC Diagnostics for Single Overhead System

Engine (Secondary) Aux Brake Diagnostics

Provides detailed operational status of auxiliary braking devices. A secondary means of Brake Mode selection is available to aid in trouble-shooting and diagnosis.

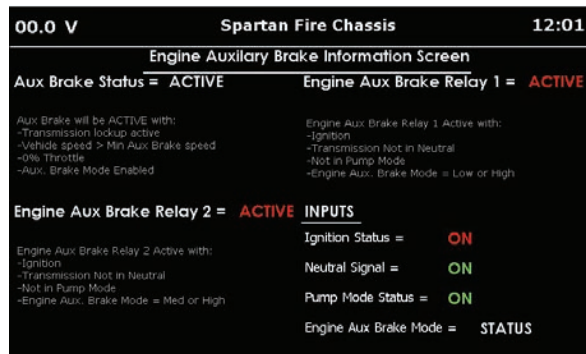

Figure 3-36. Rocker Switch

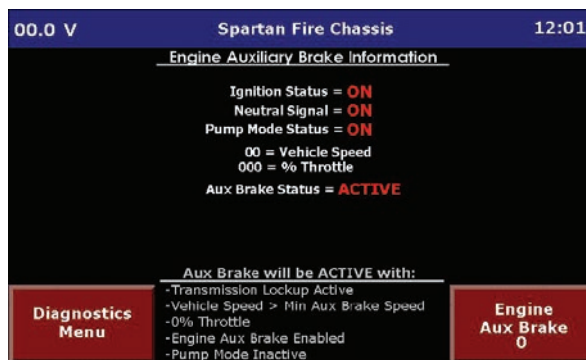

Figure 3-37. Vista Screen

High Idle Diagnostics

Provides detailed operational information on High Idle and Auto High Idle status. This screen automatically displays when either high idle state is active. If desired, screen can be disabled via "Auto" override button in bottom right corner.

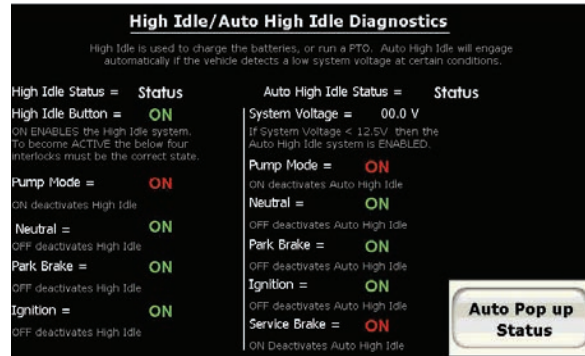

Figure 3-38. High Idle Diagnostics

Occupant Restraint Status

Provides occupant restraint status. This screen will automatically display when a seat is occupied and the seatbelt is not buckled while the park break is inactive. If desired, the screen can be disabled via the "Auto Pop-Up" button on the Vista. The setting will be saved if the truck is turned off after 15 seconds from when the setting was changed.



Figure 3-39. Occupant Restraint Status

V-MUX® Diagnostics Menu

Provides access to V-Mux® Diagnostics sub-menus.

Node Info

Verifies the Vista display operating system and version of System Designer programming software used during last download.

CONTROLS & COMPONENTS DESCRIPTIONS

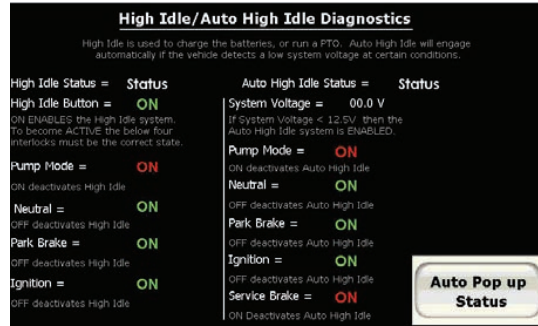

Figure 3-40. V-MUX Diagnostics Menu (Node Info)

Node Voltages

Monitors voltage and Node load shedding levels.

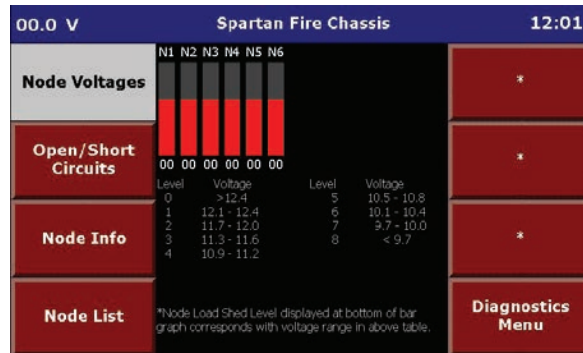

Figure 3-41. V-MUX Diagnostics Menu (Node Voltages)

Open/Short Circuits

Monitors the circuit (open/short) status of Node Outputs.



Figure 3-42. V-MUX Diagnostics Menu (Open/Short Circuits)

Node List

Displays Node types, locations, and operational status. “Ping” button allows status updates as desired.



Figure 3-43. V-MUX Diagnostics Menu (Node List)

HVAC Menu For Dual Overhead System



Figure 3-44. HVAC Menu for Dual Overhead System

The HVAC Menu provides direct access to Climate Control settings using the function buttons. Vehicle master and ignitions switches must be in the “ON” position to operate the HVAC system.

Climate Mode button

Allows selection between four specific “Modes”: OFF, CABIN, COMFORT, and DEFROST.

- **OFF** - Deactivates the climate control system.
- **COMFORT** - This mode directs air primarily on the occupants.
- **DEFROST** - This mode directs air primarily on the windshield.
- **CABIN** - This mode splits the air between the occupants and the windshield.

A/C On/Off Button

The A/C ON/OFF button located in the lower right of the display allows the operator to activate or deactivate the air conditioning compressor. When the A/C ON/OFF button is pressed to turn the compressor on, the A/C ON/OFF icon turns from grey to blue.

CONTROLS & COMPONENTS DESCRIPTIONS

Temp SetUp/ Temp Set Down Buttons

The TEMP SET buttons allow the user to adjust temperature between hot and cold. Press the TEMP SET UP button to increment the temperature setting up and press the TEMP SET DOWN button to increment the temperature setting down.

Fan Speed Control Buttons

The FRONT FANS UP/DOWN buttons allow the operator to increase or decrease the front fan speed. The REAR FANS UP/DOWN buttons allow the operator to increase or decrease the rear fan speed.

NOTICE

When in defrost or cabin air modes, air is directed toward the windshield to prevent fogging; A/C is also commanded active to dry the air inside the cabin.

The Climate Control Menu provides direct access to HVAC settings using the function buttons.

Climate Mode (HVAC Status) Button

Allows selection between four specific "Modes": OFF, CABIN, COMFORT, and DEFROST.

Fan Speed Control Buttons

Set the "mode control switch" to "comfort" mode for cab heating and cooling.

Set the "mode control switch" to "defrost" mode for windshield defrosting/defogging need. Even in this mode, 2 (two) vents will remain on for cab heating and cooling.

Cab master and ignitions switches **must** be in the "ON" position to operate the fans.

Set the "mode control switch" to "cabin" mode and this will split the airflow evenly between "comfort" mode and "defrost" mode.

The temperature control switch allows user to adjust temperature between hot and cold.

The "rear" blower speed control switch allows operator to control blower speed.

The "front" blower speed control switch allows operators to control blower speed.

The A/C switch located in the lower right of the display allows operator to activate or deactivate the A/C compressor. When the A/C on/off button is pressed to turn the compressor on, the A/C on/off icon turns from grey to blue.

Set Temperature Control Buttons

When in CABIN, COMFORT, or DEFROST mode the Set Temp Control Buttons are used to adjust the inside cabin temperature to the desired level.

HVAC Menu For Single Overhead HVAC System

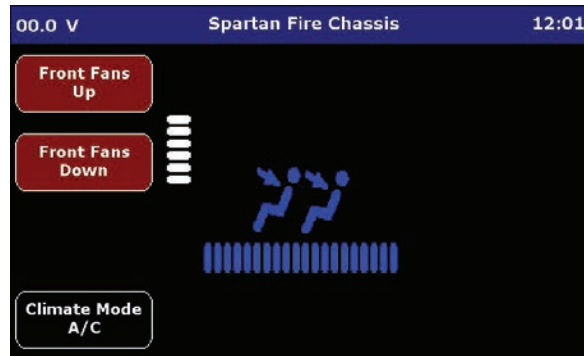

Figure 3-45. HVAC Menu for Single Overhead System

The Climate Control Menu provides direct access to HVAC settings using the multi-function (type 8) buttons.

Climate Mode (HVAC Status) Button

Allows selection between six specific "Modes": OFF, AUTO, MAX HEAT, MAX A/C, DEFOG, and DEFROST.

Fan Speed Control Buttons

Fan speed is adjustable in MAX HEAT, MAX A/C and DEFOG modes with only front fans being available in DEFROST. Fans will not be operational unless both cab Master and Ignition switches are in the "ON" position. Initial start-up defaults are at 100% to maximize operational response.

Set Temp Control Buttons

When in AUTO or DEFOG mode the Set Temp control buttons (up/down) are used to adjust the inside cabin temperature to the desired level.

NOTICE

When in DEFROST full available heat output (Max) is directed to the front windshield for optimum efficiency. As implied, MAX HEAT and MAX A/C also operate at full heating or cooling power. Temperature settings are not "User" adjustable in these modes although output can be tailored with the use of the Fan Speed control buttons.

Auto Mode

This setting regulates cabin temperature with the use of the heater control valve, fans, and A/C system. The temperature set point in comparison to the inside temperature is used to decide the system heating/cooling response and will automatically adjust the front and rear fan speeds accordingly. Output is via the side comfort and rear HVAC louvers.

Max Heat Mode

Heater valve is fully open directing maximum flow of engine coolant through the heater coils. Output is via the side comfort and rear HVAC louvers.

CONTROLS & COMPONENTS DESCRIPTIONS

Max A/C Mode

Heater valve is fully closed allowing A/C system to provide maximum cooling power. Output is via the side comfort and rear HVAC louvers.

Defog Mode

Output is via the front (defrost) and rear HVAC louvers. Heat/cool temperature provided is dependent on the user set point.

Defrost/Defog Mode

Heater valve is fully open directing maximum flow of engine coolant through the heater coils. Output is via the front HVAC louvers being directed at the windshield only. Since temperature is not user adjustable, once defrost or defogging has been achieved, it is recommended that user switch to either Auto or Defog Mode To Maintain Air Comfort At Desired Level.

Heat A/C-Climate Control Menu-Tunnel Mounted Auxiliary HVAC And Upper Heater/Defroster Unit

Climate Mode (HVAC Status) Button

Allows selection between four basic "Modes": OFF, MAX HEAT, and MAX A/C of the tunnel mounted HVAC unit. The upper heating and defrosting capabilities are provided by an independent manually operated heater/defroster unit mounted overhead just rear of the windshield.

Fan Speed Control Buttons

Fan speed is fully adjustable in both MAX HEAT and MAX A/C. Initial start-up defaults are at 100% to maximize operational response. If both front and rear fans are adjusted to OFF (0%) the current climate mode selection will automatically default to OFF Mode.

Set Temp Control Buttons

Used to adjust the inside cabin temperature (up/down) to the desired level, only operational in AUTO Mode.

Max Heat Mode

Heater valve is fully open directing maximum flow of engine coolant through the heater coils. Air output is via all louvers.

Max A/C Mode

Heater valve is fully closed allowing A/C system to provide maximum cooling power. Air output is via all louvers.

Climate Mode Button

Allows selection between three specific modes of the tunnel mounted unit: OFF, HEAT, A/C:

- **OFF** - Deactivates the climate control system.
- **HEAT** - This mode directs air primarily on the occupants.
- **A/C** - This mode directs air primarily on the windshield.

CONTROLS & COMPONENTS DESCRIPTIONS

The upper heating and defrosting capabilities are provided by an independent, manually operated heater/ defroster unit mounted overhead just rear of the windshield.

Fan Speed Control Buttons

Fan speed is adjustable in both HEAT and A/C modes. Initial fan speed defaults to 100% to maximize operational response. If both front and rear fans are adjusted to OFF (0%) the current climate mode selection will automatically default to OFF Mode.

Vista Touch Screen (If Equipped)

As an alternative to the Vista IV, an enhanced interface “Touch Screen” version of the Vista display may be installed. All user functions are located within the graphics area of the display therefore no buttons are located around the perimeter.



Figure 3-46. Vista Touch Screen (If Equipped Home Menu)

As configured, three Menus and three Control buttons are provided along the bottom row.

“E-Master”, “HVAC Control”, and “High Idle” perform the same function as on the Vista IV with an added visual color shift when toggled into the ON position.

Successive menus and screen layouts are similar to the Vista III. In addition to the Main (start-up) Home menu, sub-menu “Secondary Menu” buttons are also provided. The “Warning Menu” button (same as Vista IV) links to the Warning menu screen.

Message Acknowledge (Fire Truck Icon)

To acknowledge a message, touch the fire truck image in the center of the screen. When the truck icon is depressed, the current message is cleared in the Message Bar and the next message is displayed, if any.

VDR Screen Link (Seat Belt Icon)

When a seat belt violation occurs, the Seat Belt Icon appears on the screen to indicate the violation. To determine which seat is in violation, touch the seat icon to view the Seat Information Screen.

HVAC Screen Link (HVAC Icon)

The HVAC Control button on the bottom row is used to set the mode of the HVAC system. The mode is displayed via the HVAC Icon just above the button. To view the HVAC Climate Control Menu, touch the HVAC Icon.

CONTROLS & COMPONENTS DESCRIPTIONS

HVAC Menu For Dual Overhead HVAC System

Using the climate control menu, front and rear fans, temperature up and down adjustments can be accomplished by their respective virtual button.

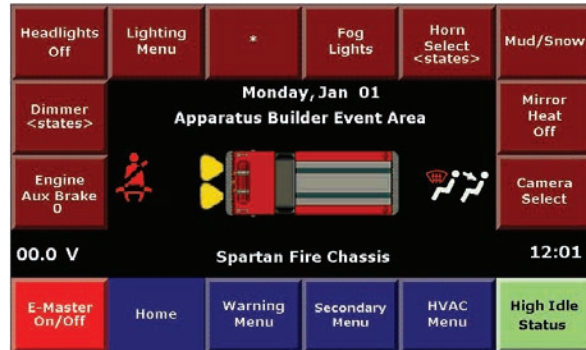

Figure 3-47. HVAC Menu for Dual Overhead HVAC System

HVAC Control Button determines the Mode of HVAC. Once Mode is determined, the front and rear fan speeds and temperature can be set using virtual buttons on HVAC menu screen.

HVAC Menu For Single Overhead HVAC System

Using the climate control menu, front and rear fans, temperature up and down adjustments can be accomplished by their respective virtual button.

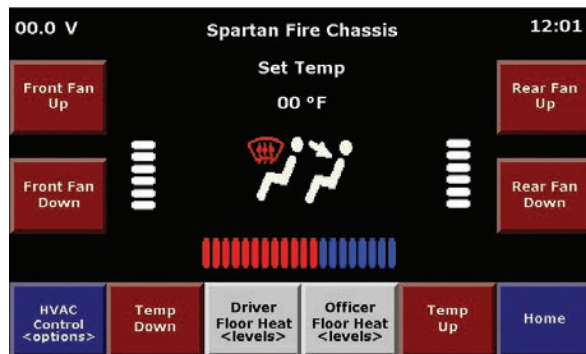

Figure 3-48. HVAC Menu for Single Overhead HVAC System

HVAC Control Button determines the Mode of HVAC. Once Mode is determined, the front and rear fan speeds and temperature can be set using virtual buttons on HVAC menu screen.

Remaining menus and screen organizations are patterned after the Vista IV detailed in the preceding section.

Final Notes:

By nature, the Weldon V-Mux® system lends itself to a high level of customization.

The behavioral characteristics or operations “Programming” of the V-Mux® system is achieved through the use of specialized software at the factory level. E-One produces and programs support consistent with the needs of the mechanical and electrical content of each particular chassis at time of chassis build. Descriptions, menus, and screens depicted within this document reflect the programming and user interface provided at the time chassis leaves our facility.

Upon completion of the chassis, the base or “Initial” programming design file passes on to and becomes the property of the Final Stage Manufacturer Contractor. Additions to the V-Mux® installation and Vista interface (sometimes extensively) are performed in order to support their requirements and specific brand recognition. As required, for information or instruction on portions of the interface not covered in this document please contact your appropriate Dealer or Apparatus Manufacturer point of purchase.

CLIMATE CONTROL

CAUTION

Always check operation and adjust louvers prior to driving the truck.

Your truck may be equipped with one of the following types of HVAC system:

1. A dual overhead HVAC system.
2. A single overhead HVAC system.
3. A single overhead heater/defroster system.
4. A tunnel mounted HVAC system.

In addition to the systems listed above your vehicle may also be equipped with a variety of auxiliary heating units typically located on the floor or under seats.

Under normal A/C system operation it is common for the A/C compressor to cycle up to two times per minute.

CONTROLS & COMPONENTS DESCRIPTIONS

Dual Overhead HVAC System

Control Head

A NON-Multiplexed system includes a control head, typically mounted in the “switch console center” in reach of the driver and officer. Refer to [Figure 3-49](#).

A multiplexed system can be accessed and controlled through the Vista display instead of using the control head. Refer to section 3 V-Mux [page 3.33](#).

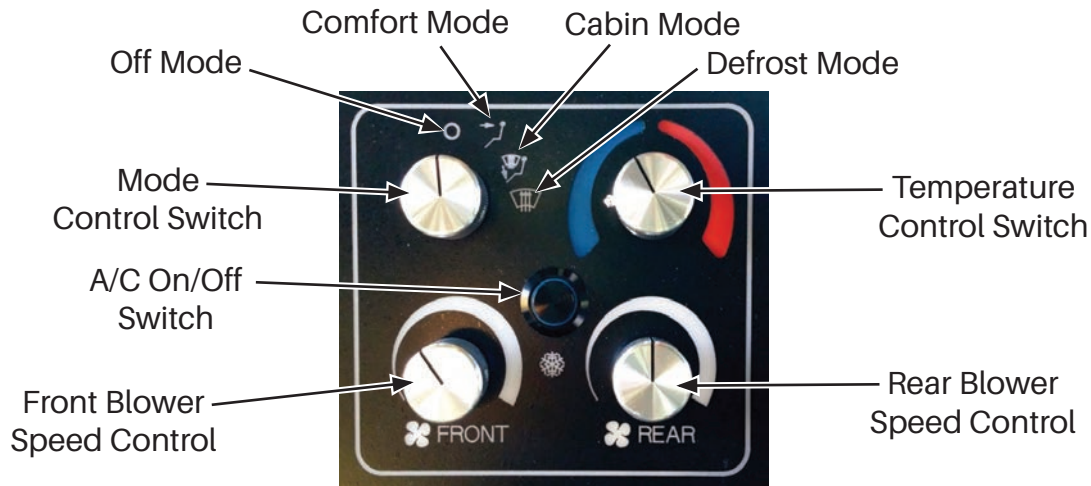

Figure 3-49. Dual Overhead HVAC System

Set the “mode control switch” to “comfort” mode for cab heating and cooling.

Set the “mode control switch” to “defrost” mode for windshield defrosting/defogging need. Even in this mode, 2 (two) vents will remain on for cab heating and cooling.

Set the “mode control switch” to “cabin” mode and this will split the airflow evenly between “comfort” mode and “defrost” mode.

The temperature control switch allows user to adjust temperature between hot and cold.

The “rear” blower speed control switch allows operator to control blower speed independent of front blower.

The “front” blower speed control switch allows operators to control blower speed independent of rear blower.

The A/C switch located in center of switch cluster allows operator to activate or deactivate the A/C compressor. When the blue light around switch is lit this indicates compressor is on.

NOTICE

When in defrost or cabin air modes, air is directed toward the windshield to prevent fogging; A/C is also commanded active to dry the air inside the cabin.

CONTROLS & COMPONENTS DESCRIPTIONS

Single Overhead HVAC System

To adjust air speed, rotate the blower control switch(s) to low, medium, or high fan speed. Louvers can be adjusted as necessary to direct the airflow. Refer to [Figure 3-49](#).

Control Head



Figure 3-50. Single Overhead HVAC System

Choose “Defrost” Mode for windshield Defrosting/Defogging need. For best performance for Defrost/Defog set temperature setting at maximum and front fan speed at maximum. Rear fan speed can be selected as desired. Defrost mode will deliver air via Defrost louvers however comfort louvers will be inactive. Refer to [Figure 3-49](#).

“Comfort” mode delivers air via comfort louvers however defrost louvers will be inactive.

Defrost louvers are fixed to position so the guide vanes are delivering air to the windshield. Refer to [Figure 3-49](#).

Filter Access



Figure 3-51. Headliner Center Section Shown

CONTROLS & COMPONENTS DESCRIPTIONS

Single Overhead Heating/Defroster System

Optional defroster fans are not shown. Refer to Figure 3-52.

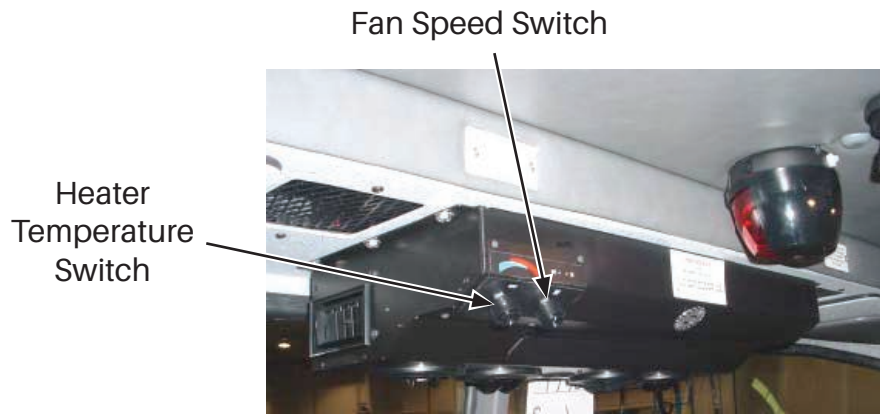

Figure 3-52. Single Overhead Heating/Defroster System

For best performance for Defrost/Defog set temperature setting at maximum and fan speed at maximum on the overhead front controls and heater.

Tunnel Mounted HVAC System



Figure 3-53. Tunnel Mounted HVAC System

Additional Auxiliary Heater Systems have Shut-off Valve (If Equipped)

NOTICE

A seasonal hot water shut-off valve (located under the cab, behind the passenger step, above the air cleaner) must be turned off by rotating the lever 90° during warm weather when air conditioning is required.



Heater Shut-Off Valve
under the Cab shown
in the "On" position

Figure 3-54. Heater Shut-off Valve Under Cab

CONTROLS & COMPONENTS DESCRIPTIONS

For future use

OPERATIONS

OVERVIEW



Read and follow the instructions found in the Safety Section of this manual before operating. Before Getting In Cab

The procedures contained this section of the Operator's Manual explain how to safely and properly operate your apparatus. Any deviation from these procedures increases the risk of an accident occurring. Accidents may result in damage to the apparatus, as well as injury or death to firefighters and other people.

PRE-OPERATION

Before Getting in the Cab

- Ensure Driver's Daily Inspection is complete and approved for service. A Sample Driver's Daily Inspection Form is available in the service section of this manual (Refer to [page 5.69](#)). It may be copied and/or altered to accommodate custom usage by the owner / operator. The appropriate fluid must be added per the engine and transmission manufacturer recommendations, with additional information available on the data tag inside the cab.
- If optional auto ejects are not used, unplug electric and airlines connected to apparatus.
- Ensure that all personnel understand the **3 points** of contact for entering and exiting the cab safely while facing the steps.

Before Driving Away

- Place master switch in the "on" position; the "battery on" indicator lamp will light.
- Place the ignition switch in the "on" position; the "ignition on" indicator lamp will light.

The instrument gauges and warning buzzers are activated, including accessory items such as the heater.

The telltales in the instrument panel briefly illuminate when the ignition is turned on to check lamp function.

- If equipped with an Electronic Fluid Level Checks (EFLC), wait 20-30 seconds before starting the engine. If the oil level "pop-up" comes on, the oil level may be low. Verify oil level by checking level with engine dipstick and fill accordingly.
- Depress engine starter button to crank engine. Release button when engine starts. (See "To Start/ Stop Engine".)
- Ensure that all personnel have seat belts fastened.
- Observe door ajar lamp for any open doors or cab tilt lock down (warning indicator is optional) not secured.
- Allow oil and air pressure to build to normal operating range.

OPERATIONS

- Battery voltage appears on the voltmeter. As a quick check to ensure the charging system is functioning, compare the voltage reading before the engine is started to the reading after it is started. The reading while the truck is running should be higher.
- Adjust driver's seat for pedal position comfort.
- Check mirrors for adjustment.
- Adjust steering wheel telescopic and tilt to a comfortable position.
- Turn head light switch on and lift turn lever for high/low beam to accommodate night driving.
- Ensure headlights are aimed, in accordance with FMVSS 108.
- If conditions require, turn on wipers by depressing lever, toggle lever up for fast and down for intermittent.
- Adjust air conditioner or heater to desired temperature setting.

NOTICE

A heater shut-off valve (on non-VMux[®] trucks only) is located on the right outside rail near the cab pivot point.

- If emergency warning lamps are required, switch on.
- Release park brake.
- Put shift selector into drive and proceed forward.
- Disengage (declutching) the four-wheel drive and tandem interaxle differentials on dry or hard surfaces **only**.
- Fire helmets **shall** not be worn by persons riding in enclosed driving and crew areas. Fire helmets are not designed for crash protection and they will interfere with the protection provided by headrests. The reduction in head clearance creates a greater hazard to personal safety than the helmets will protect.

Bumper Carrying Capacity

The total carrying capacity of the bumper, the bumper extensions, and the bumper apron is 850 lbs. All temporarily or permanently attached items to the bumper system should not exceed 850 lbs. in total weight. Any exceptions must be approved by E-One Chassis Engineering.

ELECTRIC DOOR LOCK OPERATION (IF EQUIPPED)

Unlocking and Locking of Entry Door

The entry doors must be closed for the locking actuator to function. The lock function will not operate on an open door. There are three methods to lock and unlock the cab entry doors.

1. Key Fob - press the entry unlock/lock button.

2. Keypad - enter the code and press the 1/2 button to unlock, press, and hold the 1/2 button for 3-4 seconds to lock.
3. Rocker Switch - press the momentary rocker switch in the up or down position. Some items may have a different specification due to customer requirements.

Unlocking and Locking of Compartment Doors

There are three methods to lock and unlock the compartment doors. These could be on the cab or body.

1. Key Fob - press the compartment unlock/lock button.
2. Key Pad - enter the code and press the 1/2 button to unlock, this also unlocks the entry doors. Press and hold the 1/2 button for 3-4 seconds to lock, this also locks the entry doors.
3. Rocker Switch - press the momentary rocker switch in the up or down position. This switch may be located on the vista screen if the truck is multiplexed and no rocker switch option was chosen.

Unlocking and Locking of Compartment Doors

The authority code is a code that is used to change the access code. The access code is the code that is used frequently to lock and unlock the doors. Typically, the authority code is not shared with others. Only the system integrator (owner or manager) of the vehicle would know the authority code.

Change Authority Code

This also changes the access code.

The following procedure resets all user codes to undefined values and then allows the system integrator to enter a new authority code, which is also stored as the user 1 access code. This needs to be done for each of the Key Pads.

1. Momentarily ground the learn mode input brown or tan wire located in the cab behind the rocker switches. The buzzer will sound for 3 seconds. Double beeps are provided upon any button press while in learn mode.
2. Enter the desired new authority code. Double "beeps" are provided for each key press. On the fifth key entered, an extra "beep" is played to indicate this step is complete.

Re-enter the 5-digit authority code. The Key Pad will "beep" 4 times after successful confirmation. This assigns the authority code and the user access code.

Change Access Code

1. Activate learn mode by pressing and holding the 5/6 key for 5 seconds until the Key Pad "beeps".
2. Enter the authority code, double beeps are provided after each button press.
3. To indicate successful entry of the authority code an additional beep is played.
4. A continuous beep begins playing to indicate that the user should enter which code to change. Select the code to change 1/2 user 1 access, 3/4 user 2 access code. The continuous beep stops playing. An additional beep indicates successful entry.
5. Enter the new code all five buttons can be used to enter the access code.
6. To indicate successful entry of the new access code, the Key Pad will play and additional beep.

OPERATIONS

7. Enter the new code again for confirmation. To indicate the code has been programmed successfully the Key Pad will play four continuous beeps.

TO START/STOP THE ENGINE

Normal Engine Start

NOTICE

Start the engine with the Gear Selector in Neutral and Parking Brake Set. Pad shifters always return to the neutral position when the engine is shutdown.

1. Disconnect Electric and Air Lines from Shore Source.
2. Turn Master Switch On then wait for the VMUX to display the home screen OR, if you do not have a VMUX, for the compartment open light to stop flashing.
3. Turn Ignition Switch On and observe the gauges on the instrument cluster. Wait for the gauges to stop cycling and the fuel gauge to indicate the actual fuel level.
4. Press Start Button.

Normal Engine Shut Down

With the Gear Selector in Neutral and Parking Brake Set

1. Allow engine to idle for 3 to 5 minutes.
2. Turn Ignition Off and wait for the engine to completely shut off.
3. Turn Master Off.
4. Connect Electric and Air Lines to Shore Source (If Equipped).

Emergency Engine Shut Down (If Equipped)

To activate, lift the guard and throw the switch or press lock "up" on locking rocker switch.

Before resuming operation, valve must be reset and all charge air hoses, tubes, and clamps should be inspected and repositioned if needed. To reset, rotate the lever on the valve body. If no reset lever is present on the valve body, reset by holding in the dash mounted test switch for 5 seconds.

TRANSMISSION

All operators and owners should read the transmission operation manual before operating the vehicle. For complete transmission information, refer to the applicable manual.

Shift Selector

The transmission shift selector is either pushbutton or t-handle (lever). A full description and function for each type of selector is included in the transmission operation manual supplied with your vehicle.

4 X 4 Shift Control Logic (If Equipped)

NOTICE

Operation of the front axle should occur only on off-road or poor traction conditions. Engaging the front axle on paved roads may result in; driveline wind-up, inefficient operation, and excessive tire wear.

To place the vehicle in 4-wheel drive, perform the following steps.

1. Ensure vehicle is stationary.
2. Place transmission in Neutral.
3. Move toggle switch to 4x4 position.
4. Verify the "4x4" indicator lamp is illuminated. If the lamp does not illuminate, place vehicle in gear ("D") and slowly accelerate.

NOTICE

A "clunk" sound during engagement is normal.

To disengage 4-wheel drive, perform the following steps.

1. Ensure vehicle is stationary.
2. Place transmission in Neutral.
3. Move toggle switch to 4x2 position.
4. Verify the "4x4" indicator lamp is no longer illuminated.

NOTICE

If 4-wheel drive does not disengage immediately, it may be due to wind-up in the drivelines. A short operation in reverse will usually allow disconnect to disengage.

AUXILIARY BRAKING

WARNING

Vehicles equipped with an auxiliary braking device may lose control in wet or slippery road conditions if ABS system is in the failure mode and the braking device is activated. See auxiliary brake manufacturer's manual for safe operating practices.

OPERATIONS

CAUTION

The retarder will not work when vehicle speed is below (3) three m.p.h. You must apply the chassis brake to bring the vehicle to a full stop.

VGT (Variable Geometry Turbocharger, Exhaust Brake, OR Compression Brake)

Activating the auxiliary brake switch will create automatic braking when there is no throttle application.

Some auxiliary brake designs have a switch for selection of high, low, and/or medium absorbing capacity. It is important for drivers to operate the apparatus using the various braking levels and with the auxiliary brake system off.

The auxiliary brake operates with or without service brake application.

All auxiliary brakes are most effective at governed engine speeds. Lower gear selection will give maximum retarding power. Transmission pre-select can be set for gear ranges 2-5 or 2-6 and will ensure maximum braking when brake is turned on. Pre-select keeps engine RPM speed at governor shift points for maximum braking and cooling.

In the case of an ABS event, or active faults, the auxiliary brake is automatically deactivated.

Transmission Output Retarder

Activating the Transmission Retarder switch will create automatic braking. Completely removing your foot from the accelerator applies the first one third of the retarder.

Applying pressure to the brake pedal applies the remaining two-thirds of the retarder capacity. The transmission temperature must be monitored. TURN OFF if it reaches the 300°F level.

Transmission pre-select can be set for gear ranges 2-5 or 2-6 and will ensure maximum braking when retarder is turned on. Pre-select keeps engine RPM speed at governor shift points for maximum braking and cooling to retarder and fan speed.

An optional Manual Retarder Control is available. See transmission manual for details and proper operation.

Electric Driveline Retarder

The Electric Driveline Retarder is activated by brake pedal application. The level of effectiveness is increased as the pedal is further depressed. The levels of progression are displayed by the four amber indicator lights on the instrument panel. When the retarder is activated, the brake lights illuminate.

The toggle switch (on/off) located on the switch panel near the headlight switch will enable or disable the Retarder operation. This switch is used to disable the retarder in the event of slippery road surfaces. Indicator lights are provided to show the level a braking provided by the retarder.

TANDEM INTER AXLE DIFFERENTIAL LOCK

NOTICE

This is independent of the side-to-side differential in each axle that has optional differential locks.

See your axle manufacturers operator's manual for complete details for the operation of your specific axles.

DIFFERENTIAL LOCK

See your axle manufacturers operator's manual for complete details for the operation of your specific axles.

PARK BRAKE

To apply

- Bring apparatus to a complete stop using the service brakes.
- Pull park brake valve out.
- Place the transmission selector in neutral.
- Release the service brake pedal and verify that the apparatus does not roll.

To release

- Apply the service brakes using the foot pedal.
- Push the park brake valve in. The valve must stay in and the park brake indicator turns off.



Figure 4-1. Park Brake

NOTICE

The valve will not release until the air system maintains a minimum of 35 psi.

FRONT AXLE WHEEL LOCK

Your apparatus may be equipped with an auxiliary front wheel lock option. This feature allows you to engage the service brakes on the front axle to gain additional grade holding capability, or to improve stability with the stabilizers of and aerial device deployed.

Engage the parking brake control, and then engage the auxiliary front wheel lock control. The parking brake must be engaged before the auxiliary front wheel lock will function.

OPERATIONS

WARNING

The auxiliary front wheel lock feature uses air brake system pressure to keep the front brakes applied. It should be used only with the engine running and a qualified attendant present at all times. It is a supplemental brake only, which does not meet the FMVSS parking brake criteria and must be used in conjunction with the yellow parking brake valve when parking the vehicle.

CAB TILT PROCEDURE

WARNING

Before raising or lowering the cab, safety precautions must be taken to avoid personal injury or equipment damage. Ensure frontal and overhead clearance is sufficient to fully raise cab without hitting electrical wires or dangerous overhead objects that could result in serious injury or death.

NOTICE

Ensure headlamps, compartment doors, and the grille, are secured before raising or lowering the cab.

Before Raising Cab

1. Vehicle **must** be parked on level surface with park brake on.
2. No personnel or loose equipment should remain in cab during tilt system operations. The cab tilt system is designed to tilt the cab structure only! Additional loads may cause system failure.
3. Cab doors **must** be securely closed prior to tilt operations.
4. Ensure front and overhead clearance is sufficient to fully raise cab.
5. All items in the tilt arch (suction swivels, hoses, etc.) **must** be removed from bumper apron.
6. Master switch **must** be in the "ON" position.
7. Ignition switch **must** be in the "OFF" position.
8. All personnel **must** remain clear from front and under cab at all times, the tilt system is in operation.

Raising the Cab

1. Plug in cab pendant control, if not already connected, and verify the cab has sufficient clearance to be raised.
2. Energize the electric/hydraulic pump by depressing and holding the "U" button on the remote pendant.
3. Raise cab until safety support mechanism clears the right side of the tilt cylinder housing and automatically engages on top of cylinder housing against the piston rod. Visually confirm that the safety support mechanism is fully engaged before personnel go under the raised cab.

! WARNING

Failure to ensure that the safety support mechanism is in place may result in personal injury or death.

NOTICE

It is not recommended that you lower the cab with the safety support resting up against the cylinder piston; putting the weight of the cab on the tilt cylinder housing.

4. Deactivate the electric/hydraulic pump by releasing the "U" button.

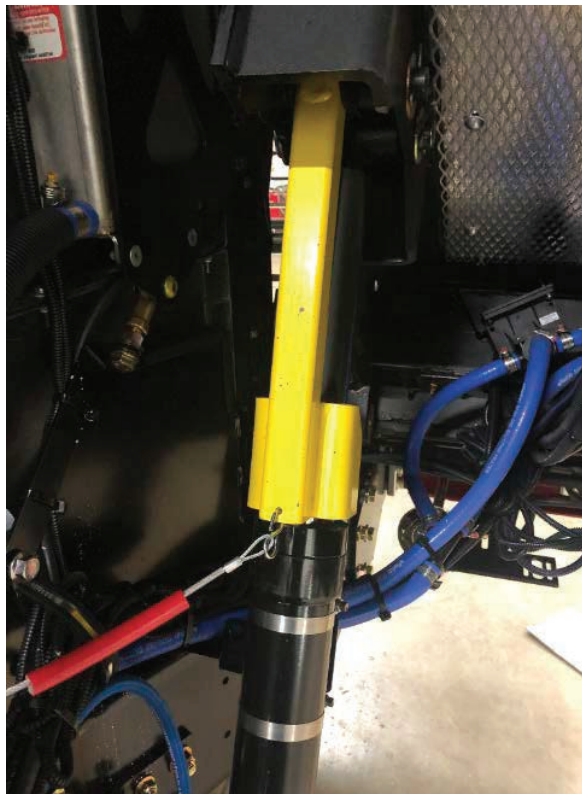

Figure 4-2. Raising the Cab - Lock Mechanism

Lowering the Cab

! WARNING

All personnel must stay clear from under cab when lowering cab or serious personal injury or death may occur.

OPERATIONS

1. Release safety support mechanism by pulling the safety support mechanism release cable. Cab may need to first be raised approximately one inch in order to remove the load from the safety support mechanism.
2. While pulling on the safety support mechanism release cable, activate the electric/hydraulic circuit by depressing and holding the "D" button. Cab slowly lowers and the red indicator on the remote pendant is illuminated.
3. The red light on the pendant illuminates any time the tilt system is activated by the "D" button, until the cab locks fully engage. The speed at which the cab lowers is pre-set and cannot be adjusted.
4. The safety support mechanism release cable **must** be released once the support channel is clear of top of cylinder housing.
5. When red indicator light turns off, both cab locks will be fully engaged. De-energize the electric/hydraulic circuit by releasing the "D" button

Manual Tilt Pump Devices (If Equipped)

If equipped, the tilt pump may be operated manually. To lower the cab manually, release the safety support cable and turn the T-handle counter-clockwise using an appropriate device. Ensure cab locks are engaged and turn T-handle clockwise to fully seat. (Cab drifts down if not seated).

If equipped, the jacking rod is mounted on the side of the pump. To raise the cab manually, insert the jacking rod into the jacking device and jack the cab up until the safety support channel clears the right side tilt cylinder housing and automatically engages on top of the cylinder housing against the piston rod. Visually confirm safety engagement.

Optional Manual Release T-handle

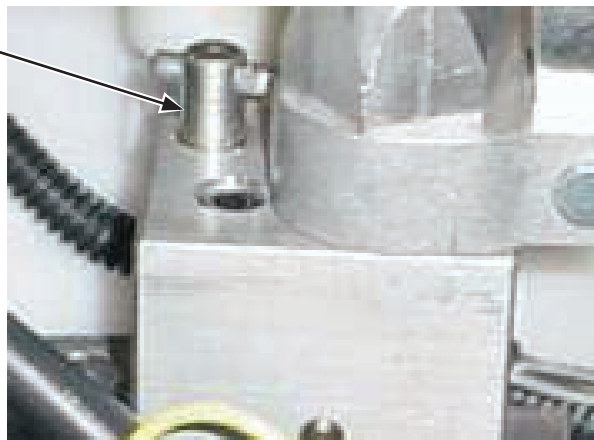

Figure 4-3. Manual Tilt Pump Devices (If Equipped)

SERVICE PROCEDURES

OVERVIEW

This section of the operator's manual provides guidelines for service checks, inspections and preventive maintenance that need to be conducted on your aerial device. The items to check and the frequency of the inspections are provided. It is paramount that required inspections and preventive maintenance be properly performed to ensure that the aerial device operates safely and properly.

Some of the inspections are simple visual checks of the aerial device. Other inspections require hands-on operation of the stabilizers and aerial ladder. It is recommended that the inspection, maintenance and testing procedures in this manual and the procedures from the latest edition of the **NFPA® 1910 Standard for the Inspection, Maintenance, Refurbishment, Testing, and Retirement of In-Service Emergency Vehicles and Marine Firefighting Vessels** be followed to ensure safe, efficient and dependable aerial operation.

It is highly recommended by E-One Motors that the department create a record for each E-One apparatus in its possession and that this record be used to track and document all work and maintenance performed on the apparatus. These records should be kept for the life of the apparatus.

CAB FINISH CARE RECOMMENDATIONS

E-One recommends that the following precautions be followed to ensure proper care of the finish on your new vehicle. If these recommendations are not followed, your paint warranty may be null and void.

The first 30 days

Avoid parking under trees - sap and bird dropping may damage the new finish. (Rinse them off as soon as possible).

Avoid driving on gravel roads - rock chips may occur on the fresh new finish.

Do not let gasoline, diesel fuel, antifreeze, transmission fluid, diesel exhaust fluid, or windshield washer fluid stand on painted surface. Rinse them off as soon as possible. **Do not wipe.**

The first 90 days

Do not wax or polish the vehicle - this will allow the finish to dry and harden completely. Do not use any silicone-containing waxes or polishes.

After 90 days, the vehicle should be polished with a premium quality product.

Consult the following manufactures for their recommendations.

3M™

Meguiars®

Do not use chalk or crayon on glass or painted cab surfaces.

Long Term Care

Never use ice scraper to remove ice or snow - this will cause scratches to the finish.

Never use abrasive cleaner, chemicals, steel wool or scuff pads directly on the finish - this will cause damage to the finish.

SERVICE PROCEDURES

Remove road salt immediately by washing and rinsing vehicle with clean water.

Rinse entire unit, including undercarriage.

Remove road tar by washing followed by a quality wax and grease remover or tar remover and a clean cotton cloth. Wipe off excess cleaner ASAP.

NOTICE

If your finish is PPG - PPG recommends finger nail polish remover or lighter fluid to remove road tar.

Proper Washing Recommendations

Do not use commercial car wash. Stiff brushes could mar the finish and damage the surface. Wash vehicle by hand with cold water and a very mild dish wash soap. Be sure to use a soft cloth or sponge.

Wash the vehicle in shade - never in direct sun.

Allow to air dry or wipe dry using clean cotton rags.

Do not "dry wipe" the vehicle - Always use clean cool water. Dry wiping could scratch the finish.

NOTICE

If your finish is PPG - PPG recommends if vehicle is washed indoors, vehicle MUST BE thoroughly air-dried.

If your finish is PPG - PPG recommends applying a compound (ECK® Electrolysis Corrosion control or Dolphin) to all screws.

Proper Add - Ons Recommendations

If any mounting of additional equipment (light, handles, etc.) are needed use the following steps.

Mount equipment with adhesive compounds or two-sided tape (consult your local 3M™ distributor) when at all possible - this will keep the finish intact and not damage it.

If drilling is required, mark holes to be drilled using a marker. Drill holes using a sharp drill bit. After drilling, remove ALL metal shavings. Prior to mounting equipment, apply LOCTITE® C5-A® compound or an equivalent product to all screws. This will prevent corrosion of any metal and helps keep paint from blistering from metal electrolysis.

ADVANCED PROTECTION SYSTEM (APS) (IF EQUIPPED)

To determine if the vehicle is equipped with APS, look for the Advanced Protection System badge on the steering wheel. When the vehicle is started, a prove out sequence will last for approximately eight seconds. After this "prove out" period, the LCD message and telltale should no longer be illuminated. If this prove out sequence does not occur, the SRS telltale remains illuminated (continues to flash), or the LCD message remains active, the APS may not be fully functioning and the APS should be serviced as soon as possible.



! WARNING

Operating the vehicle when the APS system is not fully functioning, may result in personal injury.

The APS contains inflatable air bags located throughout the cab, belt pretension devices (used to tighten seatbelt systems), and outboard sensors at the perimeter of the cab. Restraint Control Modules for the system are located under the dash on the officer side. Accessory installation on, or near, the area of the officer side dash must be done in such a way that the RCM remains accessible using basic hand tool by one person within approximately thirty minutes. **This area must be kept free from fluids.**

Once vehicle electrical power has been removed, wait five seconds prior to beginning service. If the SRS light is on (refer to control panel layout for location of SRS light) then contact E-One Customer & Product Support Group.

! WARNING

All occupants, including the driver, must wear their seat belts whether or not an air bag is provided at their seating position to minimize the risk of severe injury or death in the event of a crash.

DO NOT install additional wiring or loosen this grounding terminal. (See [Figure 5-1](#).) Compromising this connection could disrupt the E-One Advanced Protection System resulting in personal injury or equipment damage.

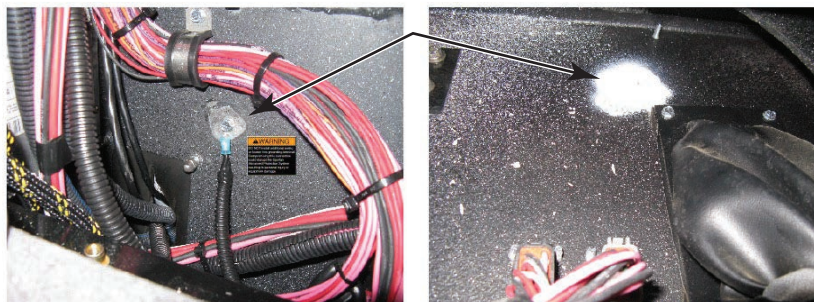

Officer Side Interior Picture

Officer Side Exterior Picture

Figure 5-1. Officer Side Interior/Exterior Photos



Figure 5-2. APS Components

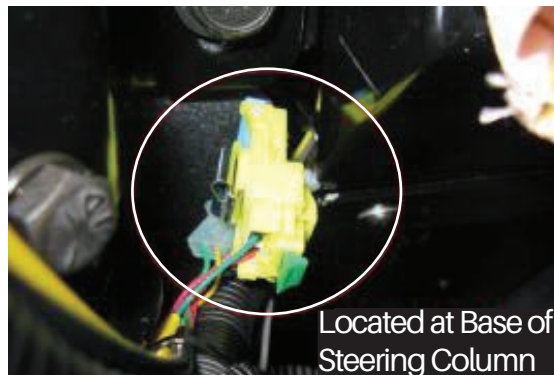

Figure 5-3. APS Components Located at Base of Steering Column

Air Bag Modules

Your vehicle may be equipped with Spartans APS (Advanced Protection System). This system includes multiple air bag modules. In order to ensure correct and uninhibited deployment, air bag modules have been identified and referenced below.

Refer to [Figure 5-4](#), [Figure 5-5](#), and [Figure 5-6](#) for Air Bag Module Locations.



Do not modify or alter the air bag modules. Serious personal injury or death may occur.

Do not modify or alter any components or areas of the vehicle in the vicinity of the air bag modules. Serious personal injury or death may occur.

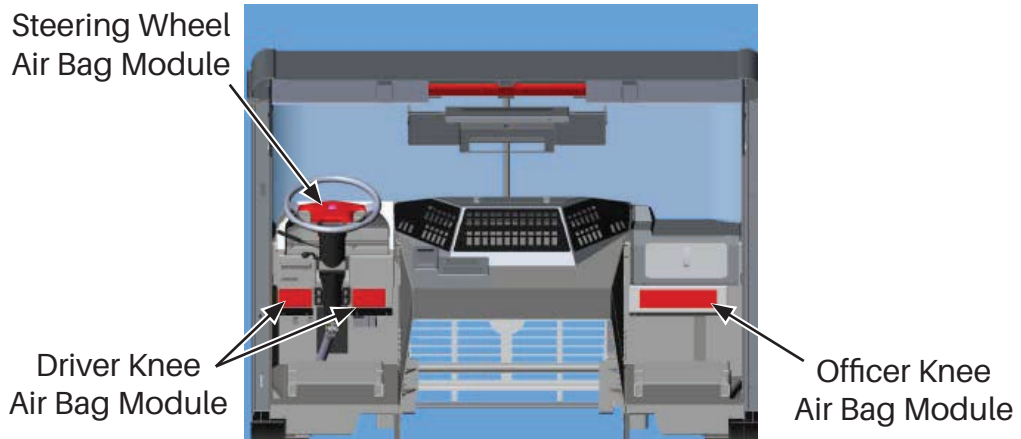

Figure 5-4. Air Bag Module Locations

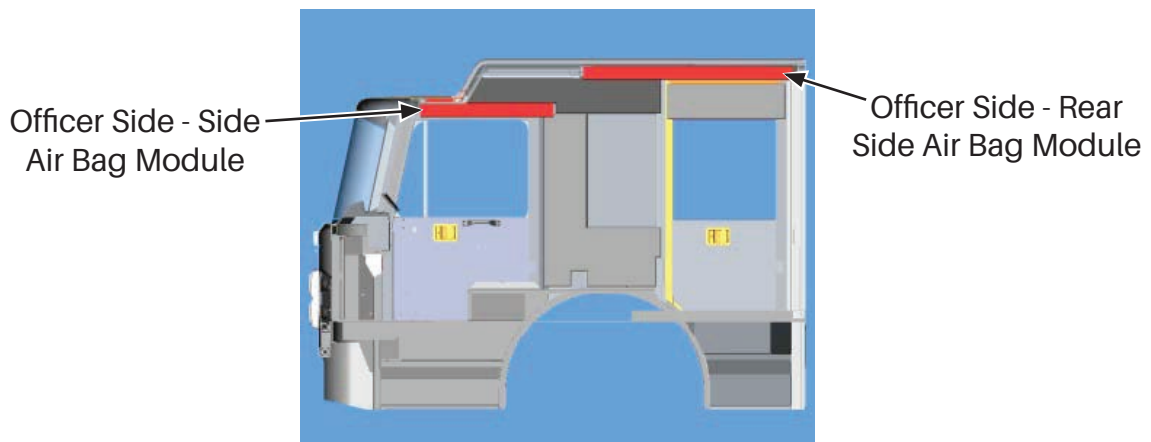

Figure 5-5. Officer Side - Air Bag Module Locations

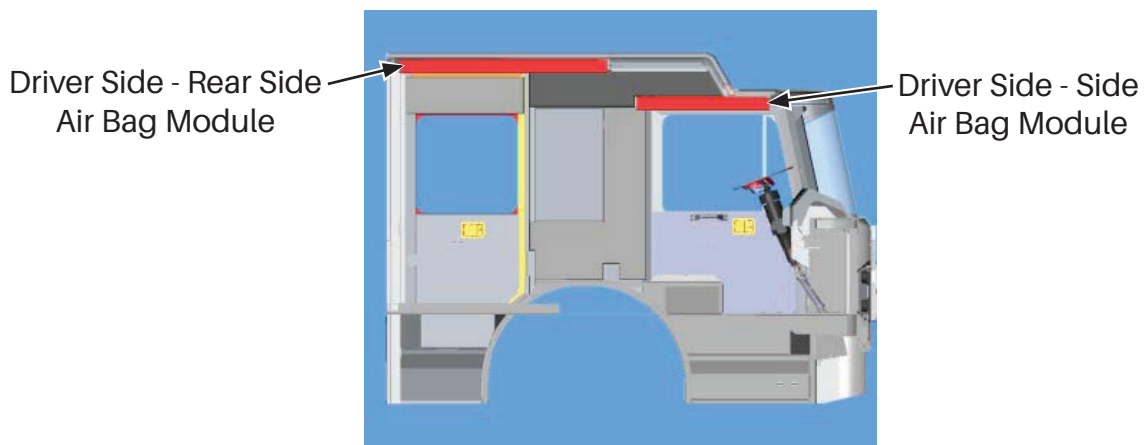

Figure 5-6. Drivers Side - Air Bag Module Locations

SERVICE PROCEDURES

Air Bag Deployment Keep Out Zones

Your vehicle may be equipped with E-One's APS (Advanced Protection System). This system includes multiple air bags. In order to ensure correct and uninhibited deployment, air bag deployment zones have been identified and referenced below.

Table 5-1: Air Bag Deployment Zones

Zones	Figures
Steering Wheel Air Bag Deployment Zone	Figure 5-7 and Figure 5-8
Driver Knee Air Bag Deployment Zone	Figure 5-9 and Figure 5-10
Officer Knee Air Bag Deployment Zone	Figure 5-11 and Figure 5-12
Driver Side - Side Air Bag Deployment Zone	Figure 5-13 and Figure 5-14
Driver Side - Rear / Side Air Bag Deployment Zone	Figure 5-15 and Figure 5-16
Officer Side - Side Air Bag Deployment Zone	Figure 5-17 and Figure 5-18
Officer Side - Rear / Side Air Bag Deployment Zone	Figure 5-19 and Figure 5-20



Do not install additional components in the areas indicated as air bag deployments zones. Serious personal injury or death may occur.

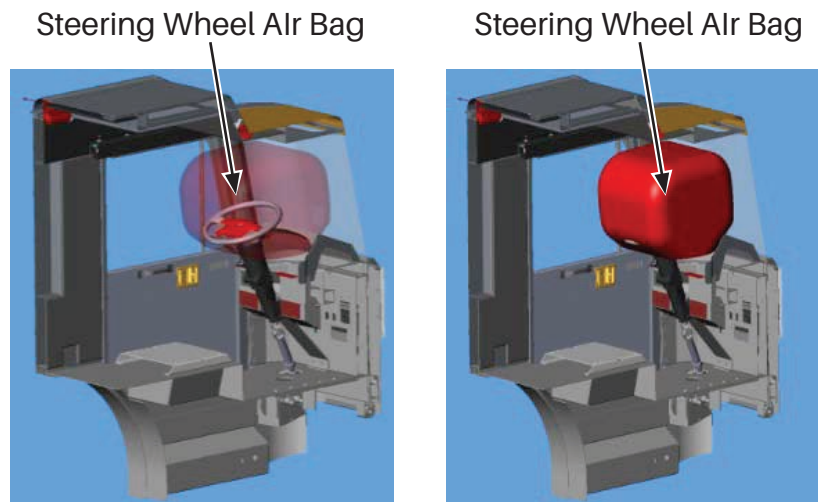

Figure 5-7. Steering Wheel Air Bag Deployment

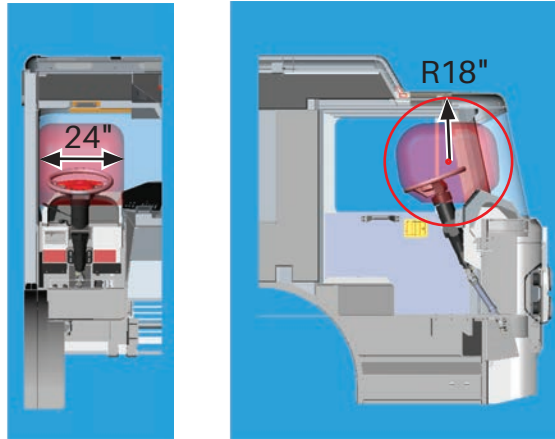

Figure 5-8. Steering Wheel Air Bag Deployment Zone

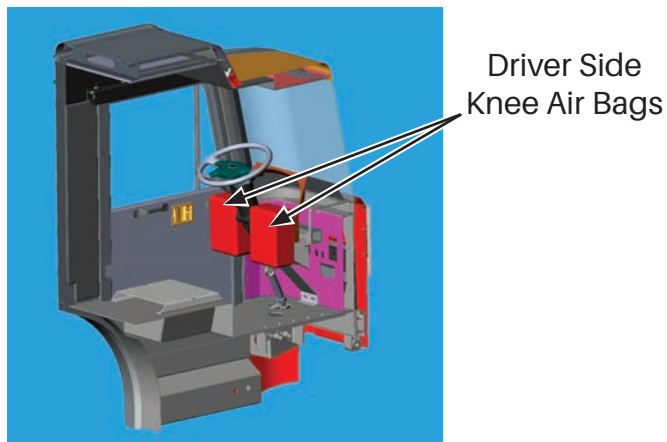

Figure 5-9. Driver Side Knee Air Bag Deployment Zone

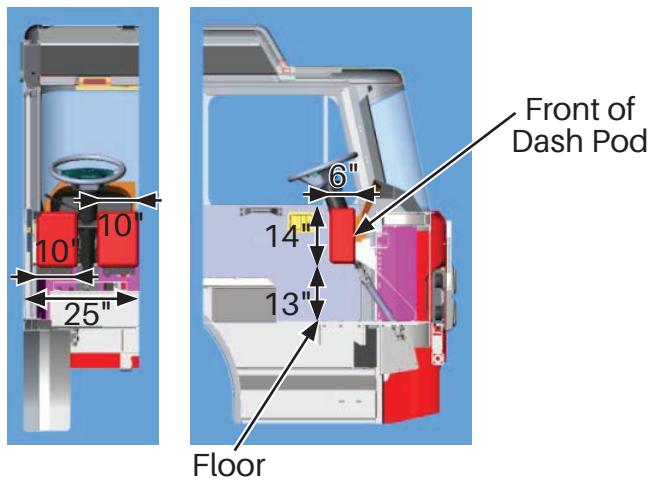

Figure 5-10. Driver Side Knee Air Bag Deployment Zone

Officer Side Knee Air Bag

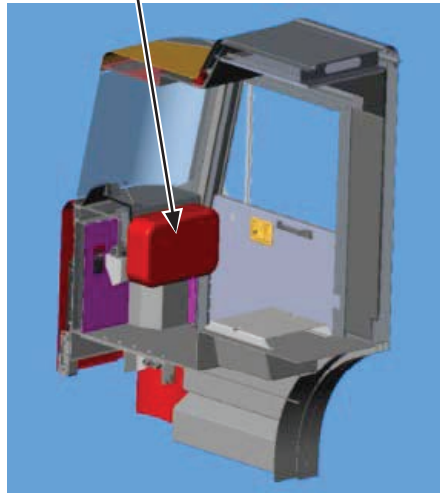

Figure 5-11. Officer Side Knee Air Bag Deployment Zone

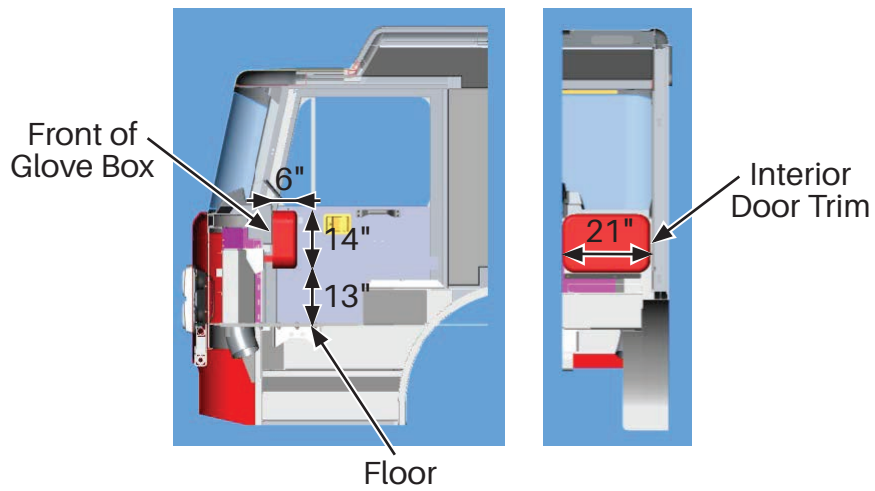

Figure 5-12. Officer Side Knee Air Bag Deployment Zone

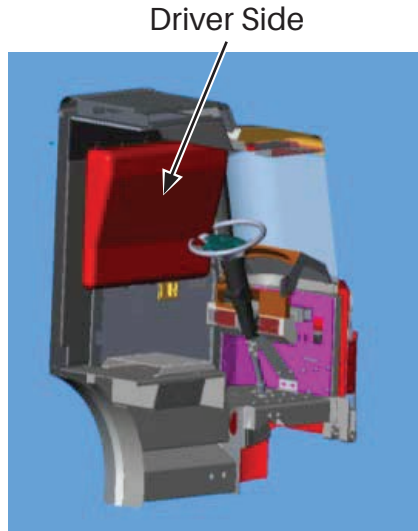

Figure 5-13. Driver Side - Side Air Bag Deployment Zone

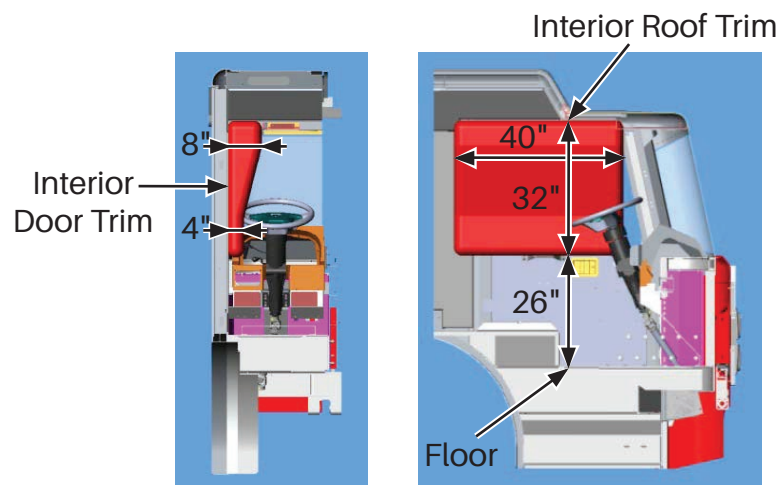

Figure 5-14. Driver Side - Side Air Bag Deployment Zone

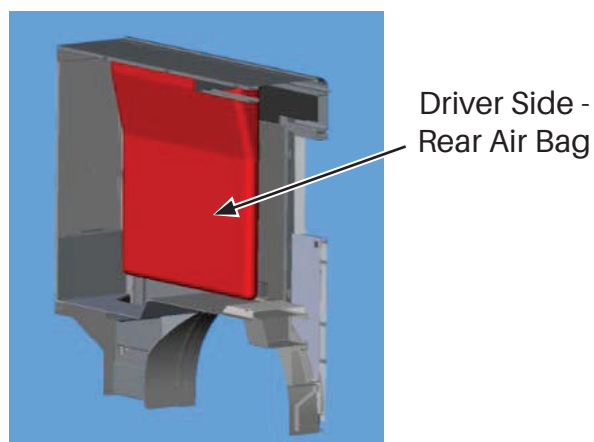

Figure 5-15. Driver Side - Rear-Side Air Bag Deployment Zone

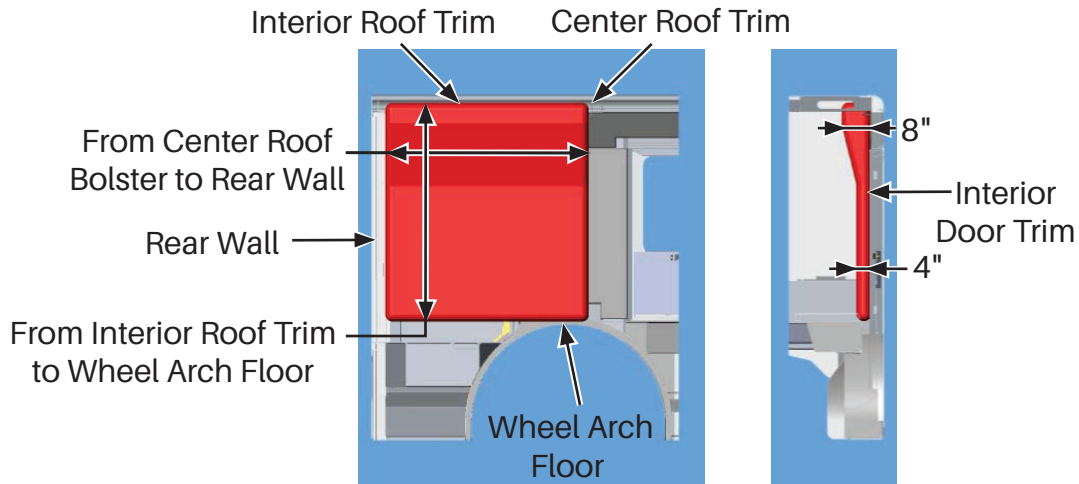

Figure 5-16. Driver Side - Rear-Side Air Bag Deployment Zone



Figure 5-17. Officer Side - Side Air Bag Deployment Zone

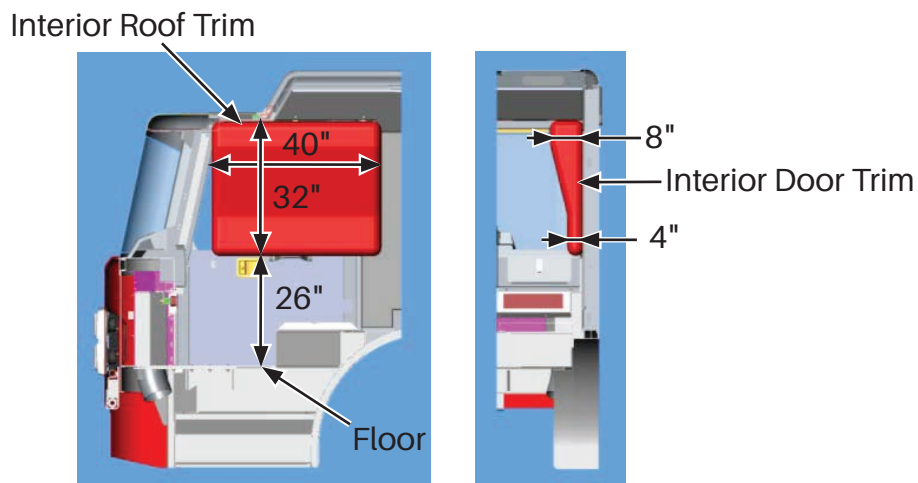

Figure 5-18. Officer Side - Side Air Bag Deployment Zone

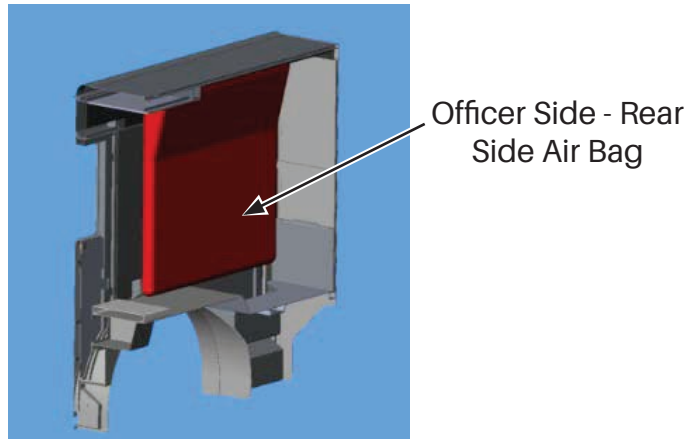

Figure 5-19. Officer Side Rear - Side Air Bag Deployment Zone

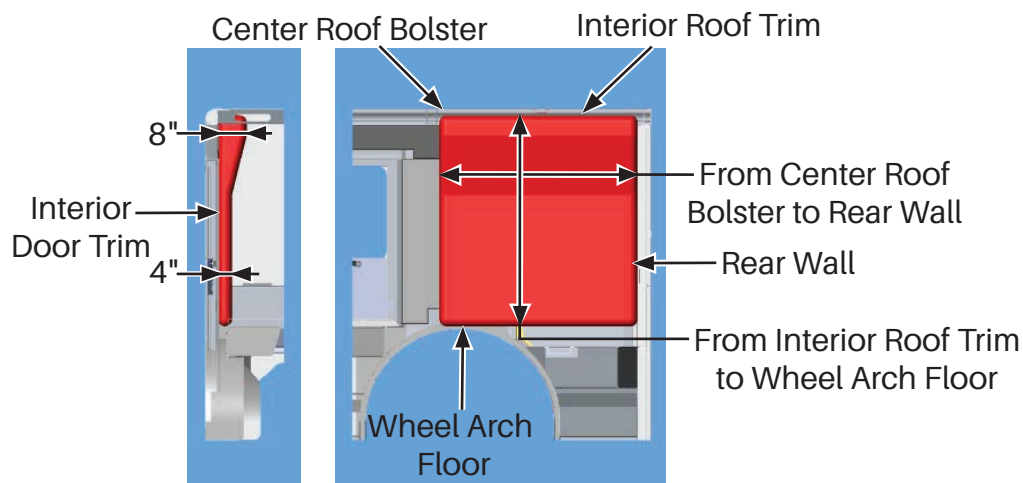

Figure 5-20. Officer Side - Rear-Side Air Bag Deployment Zone

OCCUPANCY ROLLOVER PROTECTION (ROLLTEK® SRS) (IF EQUIPPED)

Your vehicle may be equipped with an Occupancy Rollover Protection System. To determine whether your vehicle has this system, there is a Supplemental Restraint System (SRS) (label located above the sun visor). The system contains inflatable air bag's located along the side of the cab, belt pretension devices (used to tighten belt systems) and devices used to pull air seats down (if vehicle is equipped with SRS system).

Control modules for the system are located under the dash on both the officer and driver's side. This area must be kept free from fluids.

If the SRS light is on (refer to control panel layout for location of SRS light) then you are to contact E-One Customer & Product Support Group.

NOTICE

The head cushion air bag module, buckle pretensioners, and seat and occupant pretensioning system need to be replaced at 20 years.

SERVICE PROCEDURES

Supplemental Restraint System (SRS)



Figure 5-21. Supplemental Restraint System (SRS)

CAB TILT SYSTEM

The cab tilt system is comprised of a hydraulic pump that supplies high pressure hydraulic fluid to each of the cab lift cylinders in order to tilt the cab and the mechanical components that allow the cab to pivot and lock down during vehicle operation.



Modifications to the cab tilt system and its components are strictly prohibited. Modifications may result in damage to the chassis or cab, personal injury or death, or void warranty.

Use only E-One approved replacement hardware and components when servicing the cab tilt system. Failure to do so could result in damage to the chassis or cab, personal injury or death, or void warranty.

When performing maintenance on the cab tilt lift cylinders or attachment brackets and hardware, ensure that the cab is in the full down position and locked. Failure to do so could result in damage to the chassis or cab, personal injury or death. Note: that hydraulic fluid in the system may still be under pressure - use caution when working on fittings or lines.

A cab tilt limit switch option is available which limits the cab travel when tilted. Final adjustment of the limit switch **shall** prevent damage to the cab or any bumper mounted options mounted within the cab travel range.



Limit switch adjustment should NOT prevent the engagement of the safety support bar when the cab is in the raised position. Failure to do so could result in damage to the chassis or cab, personal injury or death.

Due to regular wear and tear of cab tilt components, ensure that regular inspection cycles are performed of the cab tilt cylinder pins and cotter pins. Removal of the pins are required for proper inspection; check for wear and replace worn or damaged parts.

SERVICING ADVANCE PROTECTION SYSTEM COMPONENTS

Servicing of the APS components must be performed by authorized personnel only.

! WARNING

When servicing components of the APS (including pyrotechnic devices, and sensing devices); vehicle electrical power must be disconnected prior to removal of connections or probing of pins. During service, if probing of pins is required, to reduce the probability of Electrostatic Shock Damage (ESD), ensure correct grounding of service personnel before probing pins, with either a tether or ground mat. Otherwise, if pins are not to be serviced/touched, place caps over the disconnected connectors until the harness can be reconnected. Failure to do so may cause inadvertent air bag deployments which could result in personal injury or death.

Refer to [Figure 5-22](#) and [Figure 5-23](#), which show a seat pretensioner interface connection and driver air bag interface connection, before beginning work on any components of the APS. Disconnect vehicle power then, disconnect at each location. Vehicle power **must** remain disconnected prior to connecting the interfaces points, once all connections have been made vehicle power may be restored.

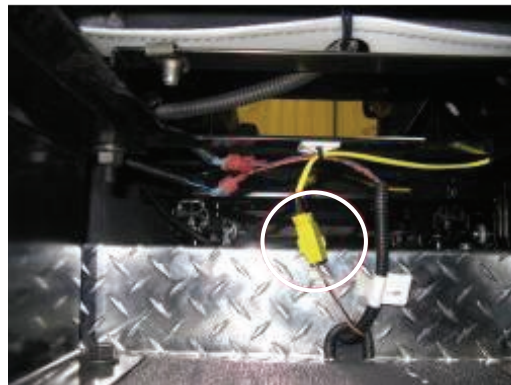

Figure 5-22. APS Components

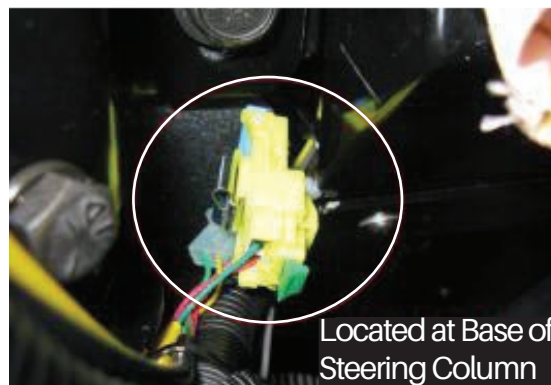

Figure 5-23. APS Components Located at Base of Steering Column

SERVICE PROCEDURES

APS Handling Do's And Don't

DO'S

- Always consider the device to be live and dangerous.
- If not certain the device is live or spent, it **must** be treated as if it is live.
- Always refer to the applicable supplier information about live devices.
- Wear the proper personal protective equipment.
- **Must** read any and all caution and warning labels on the device and abide by the instructions.
- When carrying a live air bag module, hold it with the cover pointed away from the body.
- When placing a live air bag module on any surface always place it with the cover pointed up.
- When handling a pre-tensioning seatbelt buckle assembly, hold it by the round piston tube with the end of the tube farthest from the buckle pointed away from yourself and any other person.
- When handling a pre-tensioning seatbelt retractor assembly, hold it by the protruding piston tube on the side of the retractor, or by gripping the two sides together and point the end of the tube away from yourself and any other person.

DON'TS

- **Do not** tamper with any live device.
- **Do not** attempt to take apart or diagnose any problems.
- **Do not** hammer, drill, cut, or weld on any live device.
- **Do not** apply electrical current to the device on any manner.
- **Do not** use a Volt-Ohm Meter on any live device. This must only be done by trained personnel.
- **Do not** subject a live module to extreme heat or open flame.
- **Do not** carry a live device by the electrical wires.
- **Do not** drop or throw a live device.
- **Do not** immerse in water.
- **Do not** place any objects on top of the air bag module cover.
- **Do not** set an air bag module down on its cover; the cover must be pointed up.
- **Do not** point the exit of the piston tube of a pre-tensioning seatbelt assembly towards anyone.
- **Do not** put any objects into the piston tube of a pre-tensioning seatbelt assembly.

Storage of APS Components

Storage must always be done in accordance with any federal, state, and local regulations. Local regulations **must** include local building and fire codes.

Always store a live air bag module in its approved shipping container when available. Store in a cool, dry, secure area away from all corrosives, oxidizers, ignition sources, or high heat sources. Curtain type air bags shall be stored lying as flat as possible and unfolded. Air bag modules **must** be stored with the cover facing up not down.

Shipping

Pyrotechnic devices are considered hazardous materials for shipping by the U.S. Department of Transportation. Approved packaging with correct hazardous material identification and documents **must** be completed when shipping.

TOWING (IF EQUIPPED)



DO NOT lift, raise, or support the chassis using the tow hooks or eyehooks on the frame. Follow industry safety measures when preparing and towing a vehicle. Failure to do so may lead to personal injury or death.

If a unit **must** be **towed** for any reason, subject to the options available for the vehicle, tow hooks and eyes are not to be used for this purpose. Positioning of the lifting and towing device is the sole responsibility of the towing-vehicle operator. A towing device **must** be attached to the frame assembly or axle if allowed by the axle manufacturer.

CAUTION

DO NOT release the parking brakes unless wheels are properly chocked/blocked or vehicle is securely attached to the towing vehicle.

Refer to the appropriate transmission, axle, and suspension manufacturer's literature for specific towing instructions.

Depending on the reason for towing, the vehicle **must** be properly prepared. Wheels **must** be chocked/blocked, ensure that water is emptied from water tanks (if equipped), and unload any equipment that may cause abnormal load exertion on cab and chassis components.

For towing from the front, refer to the axle manufacturer's recommended practices. To prevent damage to components, removal of front bumper and other equipment may be necessary.

For towing from the rear, front tires **must** be positioned straight ahead and the steering wheel secured in that position.

ON BOARD DIAGNOSTIC (OBD) (IF EQUIPPED)

Under Dash Console

Switch positions and layouts may vary based on console design and customer options. Not all components described in this section are included with every product. Some components are optional equipment.

SERVICE PROCEDURES

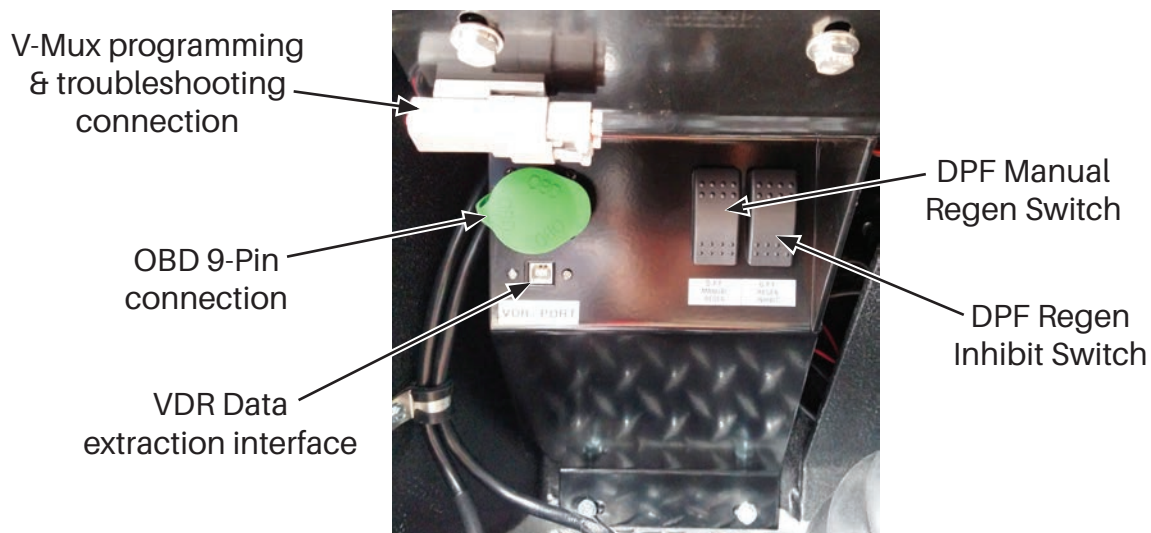

Figure 5-24. Under Dash Console

(Optional) V-Mux Programming and Troubleshooting Connection

Used with specialized software and transceiver interface to your computer for communication with the V-Mux nodes. Used for troubleshooting or programming the multiplexed vehicle system.

OBD 9-Pin Connection

Used with specialized software and RP1210 type transceiver interface between the vehicle and your computer. This connection mainly supports drive train communications and includes but is not limited to engine, transmission, and ABS braking. The green interface connector designates a 500 kilobytes per second (kbps) Data bus Speed, according to ***SAE J1939-14 - Physical Layer, 500 Kbps***. Previous 9-pin OBD interface connections are black in color and designate a 250 kilobytes per second (kbps) Data bus Speed, according to ***SAE J1939-11 - Physical Layer, 250k bit/s, Twisted Shielded Pair or J1939-15 - Reduced Physical Layer, 250k bits/s, Un-Shielded Twisted Pair (UTP)***.

NOTICE

Previous 9-pin interface connectors with the black 250 kbps connector will not work with the newer 500 kbps OBD interface.

Newer 9-pin interface connectors designed to work with the green 500 kbps system should be backwards compatible with the black 250 kbps OBD interface. Consult your diagnostic device manufacturer for more information.

VDR Data Extraction Interface

Used with specialized software and a USB A to B cable. This connection supports extraction of information from the Vehicle Data Recorder. See "**Vehicle Data Recorder (VDR) Systems**".

DPF Switches

Diesel Particulate Filter (DPF) switches are used to interface the operation of the exhaust system. Please refer to the After treatment section for application and proper operation of the switches in conjunction with the indicator lights on the dash.

OBD Requirements

The following components or systems must not be modified due to OBD/emission certification:

- Vehicle Speed Sensor.
- Coolant Level Sensor.
- Ambient Air Temperature Sensor.
- Vehicle Accelerator Pedal.
- Malfunction Indicator Lamp (MIL).
- 9-pin Diagnostic Interface connector.
- OBD designated connector by black/green cap marked, "OBD" or an uncapped 9 pin diagnostic connector.



Figure 5-25. OBD Connectors

- Any component/system of the after treatment.

Owners/Operators:

- **SHALL NOT** install object(s) that will result in abnormal temperature to occur on the emissions control system.
- **SHALL NOT** restrict access to fill tube or label for the DEF tank.
- **SHALL NOT** install anything that will cause the designated OBD, 9-pin Diagnostic Interface, connector to be covered or obstructed.
- **SHALL** maintain proper clearance of their add-on devices to the high temperature components of the emissions control systems. Refer to applicable section in engine manufacturer's manual.
- **SHALL** take their unit to an authorized service center once incorrect Diesel Exhaust Fluid has been detected.

SERVICE PROCEDURES

Malfunction Indicator Lamp (MIL) (If Equipped)

The MIL may illuminate when the ECM detects any failure that could affect tail pipe emissions. Certain failures which may occur will result in an illuminated MIL, contact an authorized service facility or E-One Customer & Support Group at 1-800-627-5050.

For additional information please refer to the applicable manufacturer's manual.

ELECTRICAL SYSTEM

Fuses

The fuses comply with the following: mini (**SAE J2077**) & Maxi (**SAE J1888**), and ATO Blade Fuse rated.

Relays

The relays are automotive relays with **ISO 280 footprint, Ultra Micro ISO Automotive relay**, or high power automotive relay.

Circuit Breakers

The circuit breakers are **SAE J553**, type 1, 2, or 3.

Battery

The Battery manufacturer's manual, included with the unit, contains information about the proper care of the batteries equipped on your chassis. Batteries must be maintained in accordance with the recommendations in the battery manufacturer's manual to ensure full battery life. Your vehicle may be equipped with an onboard battery charger for maintaining the battery's charge level during periods of inactivity. If your chassis is not equipped with such a battery charger, you must provide a means of keeping the batteries properly charged during periods of inactivity.

Battery Removal and Terminal Maintenance

When replacing batteries or disconnecting batteries for service, first turn the vehicle ignition and master switches off. Wait a minimum of 2 minutes before disconnecting battery cables. When disconnecting the batteries ensure the **positive cables are disconnected first**. The negative cables should be disconnected only after the positive cables. This will ensure proper shutdown of the engine controls and prevent possible damage to the engine control module.

Exercise caution while disconnecting battery cables, especially while the negative terminal is still connected to the vehicle frame. Inadvertent connection between the battery positive terminal and the vehicle frame, such as from an uninsulated tool, will cause arcing while the battery negative is still connected to the vehicle frame.

Replace the battery cables in reverse order, connecting the negative cables first, followed by the positive cables.

Battery terminals should be cleaned and installed with a dielectric compound or coated with battery terminal spray or clear polyurethane spray.

Battery jumper studs are provided, for ease of jump-starting.



Figure 5-26. Battery Jumper Terminals

CAUTION

Make sure the vehicle ignition and master switches are off for a least two minutes before disconnecting battery cables. Make sure to disconnect the positive battery cables first, followed by the negative cables. When reconnecting the batteries, connect the negative cables first, followed by the positive cables.

Exercise caution when disconnecting battery cables. Beware of inadvertent connection between the battery positive terminal and the vehicle frame, such as from an uninsulated tool. This may cause arcing while the battery negative terminal is still connected to the vehicle frame. Also, take care not to create an inadvertent connection between the positive and negative battery terminals. Contact of a wrench between posts, can result in a spark that could explode the battery. Disconnect the positive cable first, then the negative cable, and ECU connectors when performing electrical service, or welding on apparatus, to protect the microprocessors on chassis. Proper eye and apparel protection is required.

Interface Points

There **shall** be no case grounding of components to the cab structure, and **must** be made through the designated electrical interface points. Refer to the appropriate Final Stage Manufacturer's literature for additional information. Guidelines for Body interface requirements are provided to our Final Stage Manufacturer's as published in the Emergency Response Apparatus Builders Manual.

Communication Equipment Requirements: (Radio, Amplifier, Headset And/Or Microphone Stations, And Audio Video Equipment)

Electronic modules having audible transmission and receiving capabilities cannot achieve absolute ground therefore the following requirements/recommendations **must** be reviewed and specified, where applicable:

The OEM of the module may supply mounting and grounding specifications. Such specifications **shall** supersede the requirements listed below. However when superseded or deviated a full systems check **must** occur to assure zero transmission interference and unwanted noise for all audio systems within the vehicle.

SERVICE PROCEDURES

Radios, intercoms or other electronic communication devices **shall** be grounded to the batteries. Proper grounding techniques will aid in the reduction of noise or other sources of electromagnetic interference from degrading the performance of the device. Modules requiring chassis ground to the module envelope or case **must** have packaging specifications requiring isolated mounting assuring no electrical ground path between the module envelope or case and cab/frame.

Shielded cable **shall** be jacketed to prevent potential ground differential.

Communication cabling for audio and voice **must** be jacketed, twisted conductor and shielded.

All Communication Equipment Modules should share a single ground point.

All Communication Equipment Modules having a designated return ground should be connected to common ground connection.

All Communication Equipment Module Ground and Communication Equipment Module Chassis Ground (envelope or case) must never be connected to clean ground connection.

Antenna cable shield should be designed to drain at one end of the shield while the other shield end remains open.

Antenna base mount grounding requires ground draining. Assure Radio Module isolation from all chassis grounds.

All communication cabling **shall** be packaged 200mm +/-25mm away from all inductive loads (ignition circuits, motors, actuators, solenoids, relays, nodes, etc.)

Remote communication stations when affixed to the cab or frame **shall** not rely on attachment hardware to provide chassis ground.

The requirements of Communication Equipment Requirements are to be shared with downstream customers not limited to Intermediate manufacturers, final stage manufacturers, Dealer/Distributor, and retail customers for the prevention unwanted noise and video distraction through ground looping caused by improperly installed communication equipment to the ground system of the electrical distribution system.

E-ONE MOBILE GATEWAY (IF EQUIPPED)

The E-One Mobile Gateway is an internet connectivity solution to provide access to data regardless of location. The system provides a Wi-Fi hotspot to users in the area. Additionally, the system will automatically switch from 4G to 3G, or between providers if multiple cell cards are used when the signal gets too weak. After initial installation of the cellular card, the device requires no further user interaction. The device will typically be located behind the officer seat or above the side headliner



Figure 5-27. Typical E-One Mobile Gateway (If Equipped)

The E-One Mobile Gateway does not come with a cell modem; one must be supplied and connected by the end user. Please refer to the connectivity device documentation located in the manufacturer's literature on correctly installing the cell modem. Once installed, please consult with the manufacturer to activate the system. Contact information is in the same documentation described above.

CLIMATE CONTROL

Dual Overhead HVAC Filter Access

Intake filters may be removed for cleaning and are located behind removable panels in both front and rear covers. Refer to [Figure 5-28](#).

These filters can be removed and cleaned with soapy water.

Filters may be removed for cleaning when necessary. For optimal performance, clean the filters regularly with warm soapy water and dry before reinstalling.

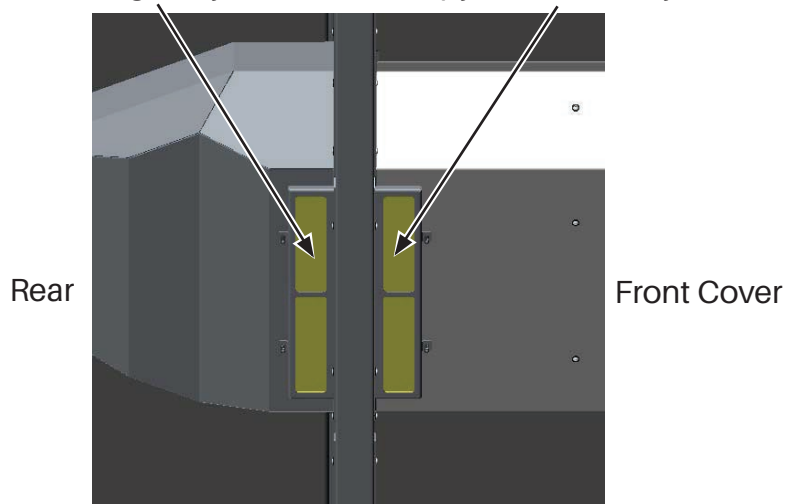

Figure 5-28. HVAC System Filter Access

SERVICE PROCEDURES

Condensate Drain Lines

Raised roof vehicles equipped with dual overhead HVAC units have two condensate drain lines. The LH drain line runs from ceiling mounted evaporators along the LH upper cross member to the LH B-Pillar, then down through B-Pillar (refer to [Figure 5-30](#) and [Figure 5-31](#)) and out bottom of vehicle, just inboard of the LH front wheel (refer to [Figure 5-29](#)). The RH drain line is symmetrically opposite and exits inboard of RH front wheel. It is very important that both drain lines remain clean, open, and free from debris buildup. This document describes recommended procedure for cleaning drain lines. It is also recommended that this cleaning procedure **shall** be utilized every 12 months (customers in hot and humid environments may need to clean the condensate drain lines more frequently than every 12 months).

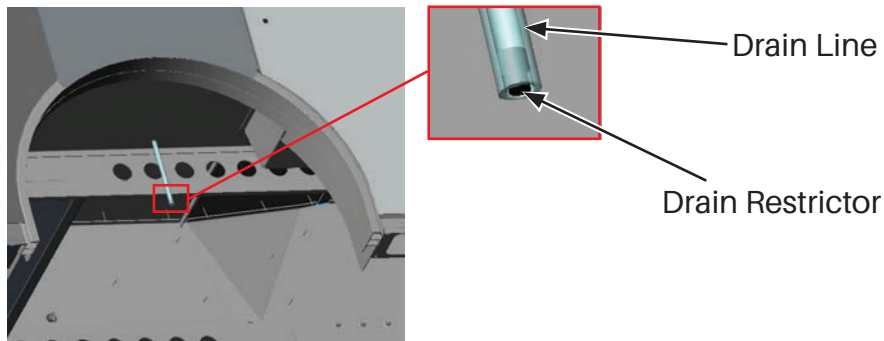

Figure 5-29. HVAC System Condensate Drain Lines

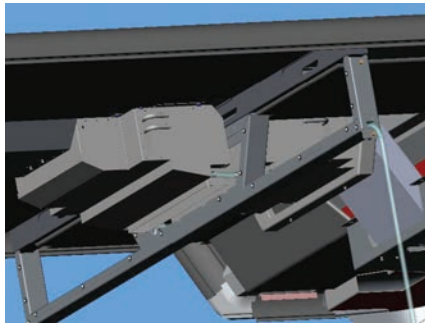

Figure 5-30. Access to Evaporators and Top of Drain Lines

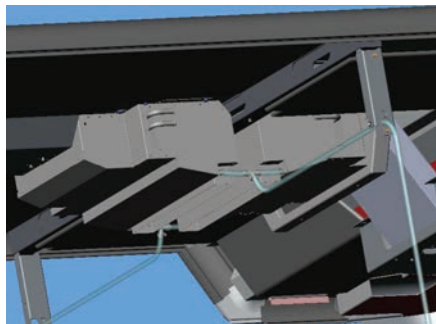

Figure 5-31. Evaporators and Top of Drain Lines



Figure 5-32. Airflow Direction

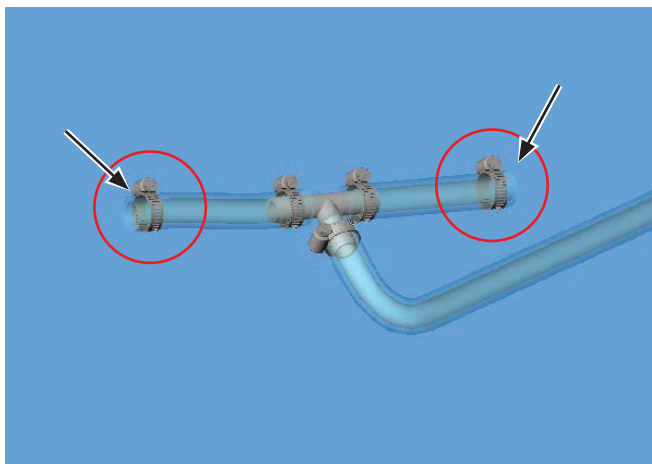

Figure 5-33. Evaporators Hose Clamps

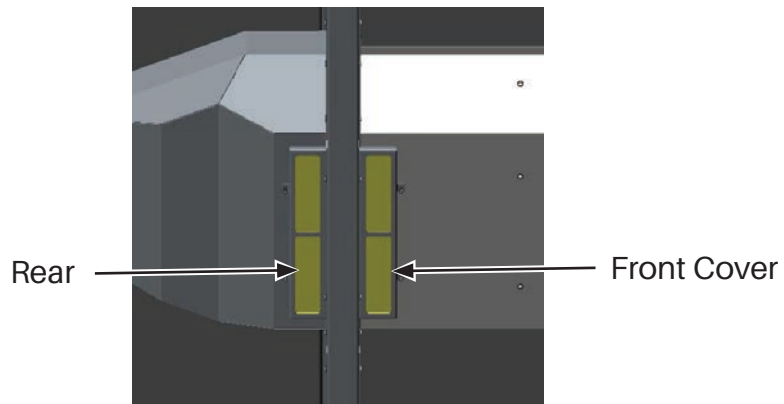

Figure 5-34. Re-install Front and Rear HVAC Covers

SERVICE PROCEDURES

1. Locate LH drain line and restrictor. This is located just inboard of the LH front wheel. Refer to [Figure 5-29](#).
2. Remove restrictor from drain line and retain for reuse.
3. Remove both front and rear HVAC covers. Refer to [Figure 5-34](#). This will allow access to evaporators and top of drain lines. Refer to [Figure 5-30](#) and [Figure 5-31](#). Some structure has been removed from Figure 5-10 for clarity.
4. Loosen the two hose clamps indicated in [Figure 5-33](#) and carefully pull the drain lines off the evaporator drain pans.
5. Apply 40-60 PSI/275.8-413.7 kPa shop air to one of the open ends of the drain line while plugging other end (refer to [Figure 5-33](#)) this will clear out drain line. Then apply same 40-60 PSI/275.8-413.7 kPa shop air previously plugged end while plugging the opposite end. Refer to [Figure 5-32](#) for airflow direction.

NOTICE

Placing a bucket under vehicle at drain line exit location will catch any and all debris.

6. Once drain line is clean, reassemble drain line onto the evaporator drain pan and tighten hose clamps using an appropriate clamp force.
7. Locate the LH drain line described in steps 1 & 2 and re-install drain line restrictor. Refer to [Figure 5-29](#).
8. Follow steps 1 thru 7 on the RH drain line.
9. It is recommended that the A/C unit be run for several minutes prior to reinstalling the HVAC covers to ensure that condensate passes thru drain line and exits vehicle without connection points leaking.
10. Re-install front and rear HVAC covers. Refer to [Figure 5-34](#).

CAUTION

Always check operation and adjust louvers prior to driving the truck.

HVAC Venturi Drain Maintenance (If Equipped)

Vehicles equipped with an overhead HVAC unit have two methods of condensate management. One method utilizes a "venturi pump" as depicted in [Figure 5-37](#). It is very important that the drain lines remain clean, open, and free from any debris buildup. This document describes the recommended procedure for cleaning the venturi drain style only. It is also recommended that this cleaning procedure **shall** be utilized every 12 months (customers in hot and humid environments may need to clean the condensate drain more frequently than once every 12 months).

1. Remove the air intake filter from the overhead HVAC cover. This will allow access to the drain line, white plastic fitting, and drain pan. For clarity, [Figure 5-35](#) shows the entire cover removed.
2. Carefully loosen the white plastic fitting.

- Gently pull the drain line out of the white plastic fitting.

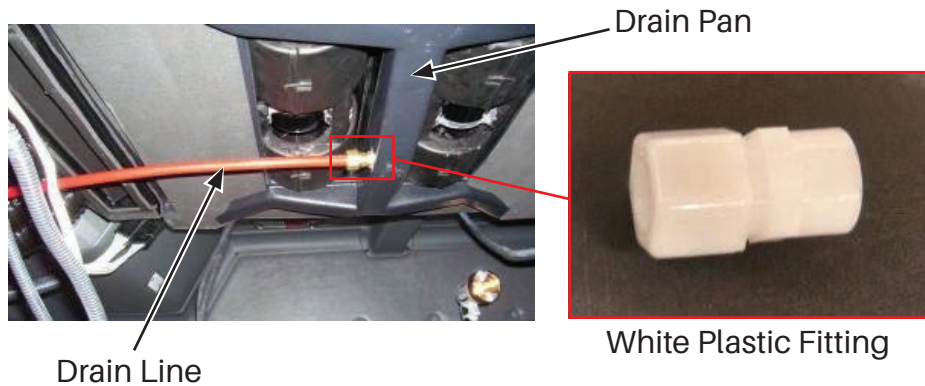

Figure 5-35. HVAC Venturi Drain Maintenance (If Equipped)

- Carefully loosen the brass fitting located on the venturi pump. The venturi pump is located behind the cab grille as depicted in [Figure 5-36](#). The grille may be removed or the cab may be tilted (refer to [Figure 5-37](#) for pump viewed with cab tilted) for ease of access. This fitting should be a "1/4-1/2 turn" over hand tight. If you are unable to loosen by hand, two wrenches may be used. Take great care when using wrenches so you **do not** damage the venturi pump.

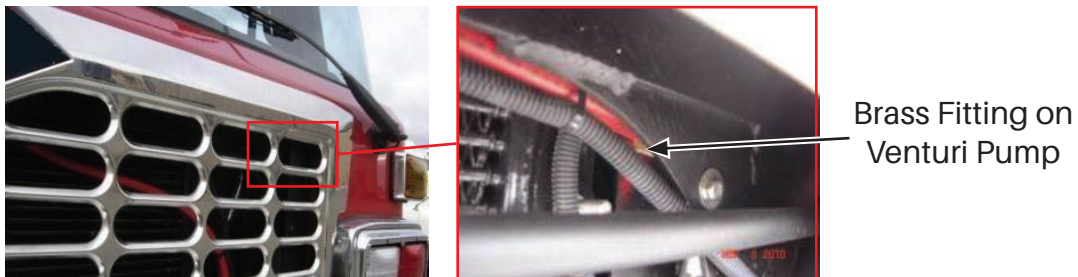

Figure 5-36. Venturi Pump Location

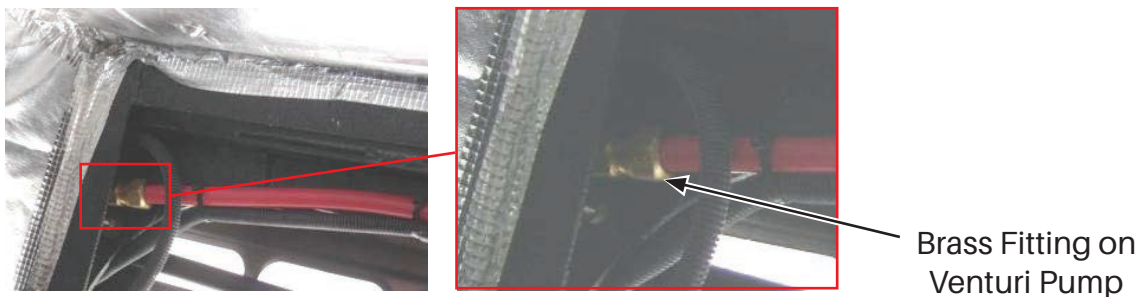

Figure 5-37. Venturi Pump Location Cab Tilted

SERVICE PROCEDURES

5. Gently pull the drain line out of the brass fitting on the venturi pump, and then push thru the grille refer to [Figure 5-35](#) and [Figure 5-36](#).
6. Apply 40-60 PSI shop air to the end of the drain line located in the cab described in sections 1 thru 3. This will clear out the drain line.

NOTICE

Placing a bucket under the drain line located in the grille area will catch any and all debris.

7. Once the drain line is clean, reassemble the drain line into the white plastic fitting in the cab Figure 6-11 and tighten 1/4-1/2 turn past hand tight. If using wrenches to tighten, take great care not to damage the drain pan.
8. Reassemble the drain line into the brass fitting on the venturi pump and tighten 1/4-1/2 turn past hand tight. If using wrenches to tighten, take great care not to damage the venturi pump. Refer to [Figure 5-35](#) and [Figure 5-36](#).
9. **If the cab has been tilted for access, you must lower the cab at this point.**
10. It is recommended that the A/C unit is run for several minutes prior to installing the HVAC cover or intake filter to ensure that condensate passes thru both fittings and exits the vehicle without the fittings leaking.
11. Re-assemble the air intake filter and/or HVAC cover.

HVAC Gravity Drain Maintenance (If Equipped)

Vehicles equipped with an overhead HVAC unit have two methods of condensate management. The second method utilizes a "gravity drain" as depicted in [Figure 5-35](#) above. It is very important that the drain lines remain clean, open, and free from any debris buildup. This document describes the recommended procedure for cleaning the gravity drain style only. It is also recommended that this cleaning procedure **shall** be utilized every 12 months (customers in hot and humid environments may need to clean the condensate drain more frequently than once every 12 months).

1. Remove the air intake filter from the overhead HVAC cover. This will allow access to the drain line, white plastic fitting, and drain pan. For clarity, [Figure 5-35](#) above shows the entire cover removed.
2. Carefully loosen the white plastic fitting. This fitting should be a "1/4-1/2 turn" over hand tight. If you are unable to loosen by hand, two wrenches may be used. Take great care when using wrenches so you do not damage the drain pan.
3. Gently pull the drain line out of the white plastic fitting.
4. Apply 40-60 PSI shop air to the end of the drain line. This will clear out the drain line.

NOTICE

Placing a bucket under the vehicle at the drain line exit location will catch any and all debris.

5. Once the drain line is clean, reassemble the drain line into the white plastic fitting and tighten 1/4-1/2 turn past hand tight. If using wrenches to tighten, take great care not to damage the drain pan.

6. It is recommended that the A/C unit is run for several minutes prior to installing the HVAC cover or intake filter to ensure that condensate passes thru the fitting and exits the vehicle without the fitting leaking.
7. Re-assemble the air intake filter and/or HVAC cover.

ENGINE

The power train of this vehicle is equipped with certain components that may be warrantable against defects or mis-builds for a period of five years, 100,000 miles, or 3,000 engine hours, whichever occurs first. If a defect or mis-build is identified in components in the power train, contact E-One Customer & Product Support at 800-543-5008.

NOTICE

Throughout the manual the term “routinely”, used in regards to maintenance, refers to intervals based on use/location of the individual emergency response cab and chassis.

General Information

This E-One cab and chassis was provided with engine and aftertreatment technology that are required to meet emissions from mobile sources Environmental Protection Agency (EPA) / California Air Resources Board (CARB) requirements. It was engineered, tested, and certified in accordance with strict installation, performance, and regulatory requirements imposed by the Federal government as well as component manufacturers. Modifications to the power train, or its associated systems, may directly affect safety, reliability, or performance. Certain modifications may lead to noncompliance to governmental regulations and are prohibited without prior approval from E-One Engineering and the engine manufacturer. Additionally, any custom bodywork or equipment mounted to the cab and chassis in the vicinity of the power train or related components may provide similar detrimental effects and are also prohibited without prior approval from E-One Engineering. Failure to comply may result in the voiding of warranties and the occurrence of an emissions noncompliance event that may be considered tampering and punishable by the assessment of penalties by the EPA and CARB, as well as the need for remedial measures.

Engine/Emissions

The primary function of the engine is to work in conjunction with the transmission and other drive train components to produce and transmit power to the wheels for vehicle movement. Secondary functions include providing power to auxiliary components and systems such as hydraulic pumps, water pumps, etc.

This E-One cab and chassis utilizes an engine that meets current emissions regulations.

The engine installation is certified with the engine manufacturer to meet all performance requirements and government regulations. Modifications to the engine and related system are strictly prohibited without approval from E-One Engineering and the engine manufacturer.

SERVICE PROCEDURES

Exhaust/Aftertreatment

The primary function of the aftertreatment system is to filter exhaust gases from the engine before it is dispersed into the atmosphere.

This E-One cab and chassis utilizes various exhaust/aftertreatment configurations that meet the current emissions regulations. Please contact E-One Engineering for questions regarding all possible exhaust/aftertreatment configurations.

The exhaust installation is certified with the engine manufacturer to meet all performance requirements and government regulations. Modifications to the exhaust system are strictly prohibited without approval from E-One Engineering and the engine manufacturer.

Cooling System

Primary function of the cooling system is to dissipate the heat generated by the engine, transmission, and other auxiliary components. SCR emissions engines also utilize the cooling system as a heat source in cold weather climates for proper emissions functions.

This E-One cab and chassis utilizes a charge air cooler (CAC) and a radiator cooler configuration to meet the cooling requirements of the engine. Additionally, a transmission cooler is oriented in the coolant loop to meet the cooling requirements of the transmission.

The cooling system installation is certified with the engine manufacturer to meet all engine performance and associated emissions requirements. Cooling system performance can be effected by changes in bodywork and/or equipment mounted to the chassis cab unit. Modifications to the chassis cab, which may impact air flow or otherwise hinder cooling system performance are strictly prohibited without prior approval from E-One Engineering and the engine manufacturer.

NOTICE

Modifications to the engine, engine systems or related components, engine fuel system, fuel tank plumbing or surrounding areas, engine lubrication system, engine/accessory drive system, and or engine air intake system are strictly prohibited without approval from E-One Engineering and the engine manufacturer. Modifications may result in loss of performance, emissions compliance violations and/or void warranty.

The engine manufacturer's Owners Manual must be referred to for all general engine operations and maintenance requirements. The engine manufacturer's service and/or operations and maintenance documentation must be referred to for all service procedures to be performed. In addition to engine manufacturer's documentation, the following information is provided for common engine system operation and maintenance.

Fuel System

Dependable operation of the engine requires a properly designed fuel system and a source of clean fuel meeting engine manufacturer requirements.

Fuel Type

Fuel is the fluid used in diesel engines to promote combustion and produce power. Proper fuel type is critical to the operation of the engine. Refer to the engine manufacturer's documentation for proper selection, cautions, and warnings regarding fuel type.

Fuel Maintenance

Fuel cleanliness is critical to the performance and longevity of the engine. Refer to the engine manufacturer's documentation for intervals required to drain water in fuel, intervals to maintain fuel filters, and procedures for safely servicing the overall fuel system.

NOTICE

Running an engine without fuel or with restricted fuel flow may result in loss of performance and engine damage.

Do not overfill fuel tank.

Fuel Priming

Fuel priming may be necessary after filter changes, running out of fuel, maintenance, etc. Fuel priming options may include engine pump, non-engine manual pump, non-engine electric pump, etc.

NOTICE

Starting the engine without a properly primed fuel system may result in engine damage.

Fuel Tank

The fuel tank mounting and location was designed to accommodate removal from the vehicle.

Fuel Cooler

Fuel coolers may be present in a fuel system to maintain proper fuel temperatures to the engine. The typical mounting location for the fuel cooler is at the rear of the vehicle near the fuel tank.

NOTICE

Fuel temperatures may elevate if obstructions are added near the fuel cooler, contaminants are allowed to collect on the fuel cooler or damaged cooling fins exist. Fuel temperatures beyond the maximum operating temperatures may result in loss of performance and engine damage.

Regular inspection of the fuel cooler is necessary for overall performance of the fuel system. The fuel cooler should be maintained so the cooling grid is clean and free of contaminants, otherwise fuel overheating may occur. Clean, low pressure water flushed through the cooling fins, and a soft brush to remove debris is recommended for cleaning.

NOTICE

The use of high pressure air, high pressure water and/or caustic cleaning solutions may damage the fuel cooler causing premature failure or fuel overheating.

SERVICE PROCEDURES

Lubrication System

Reliable operation of the engine requires a properly maintained engine lubrication system.

Lubrication Type

Engine oil is the fluid that lubricates internal engine components during engine operation. Proper engine oil is critical to the performance and durability of the engine. Refer to the engine manufacturer's documentation for proper selection, cautions and warnings. Refer to the data label above the sun visor for fluid type and quantity as provided by E-One.

Lubrication Maintenance

Regularly maintained oil and filters are critical to the performance and durability of the engine. Refer to the engine manufacturer's documentation for intervals required to check/maintain the oil level, intervals to change engine oil and filters, and procedures for safely servicing the oil system.

Lubrication Dipstick

Engine oil dipstick is used to check oil level to engine requirements. The dipstick handle is typically yellow and can be located in various locations based on application, ranging from access under the cab to remote access through a hatch.

Lubrication Electronic Level Sensor

In applications where engine oil dipsticks cannot be accessed without tilting the cab, electronic oil level sensors are installed in the oil pan and indicate through diagnostics when the engine oil level is low and requires additional oil. This oil level sensor location may not correlate exactly with the add mark on the dipstick, but is approved by the engine manufacturer for electronic oil low level sensing.

Lubrication Fill Port

Engine oil fill port is used to add oil as needed to bring the oil level on the dipstick to proper operating range. The engine fill port can be located in various locations based on application, and can range from access under the cab to remote access through a hatch.

Engine/Accessory Drive System

The drive system allows for engine components (such as water pump) and accessory components (such as air conditioning compressor) to operate properly.

Drive Belt Maintenance

Belts used to drive engine and accessory components **must** be properly maintained for dependable operation. Cracks, glazing, tears, cuts, and excessive wear found during inspection will indicate when belts must be replaced. Refer to the engine manufacturer's documentation for belt inspection intervals, tension inspection intervals, and procedures to service and maintain the drive belts. Drive belt routing schematics are provided in documentation for each vehicle. If drive belt replacement is necessary, original replacement parts are required to avoid possible operational defects.

Drive Component Maintenance

Pulleys, idlers, tensioners, and other drive components **must** be properly maintained for dependable operation. Pulley damage, improper belt tracking/alignment, improper belt tension, etc. found during inspection may indicate component maintenance is needed. Refer to the engine manufacturer's documentation for intervals required to inspect belt tension, inspect component condition, and procedures to service/maintain the drive components. If drive component replacement is necessary, original replacement parts are required to avoid possible operational defects.

Air Intake System

Provides a means for clean, temperature regulated air to enter the engine. Typical air intake systems (Refer to [Figure 5-38](#) and [Figure 5-39](#)) consist of all components from the intake of external air up to the turbo-charger.

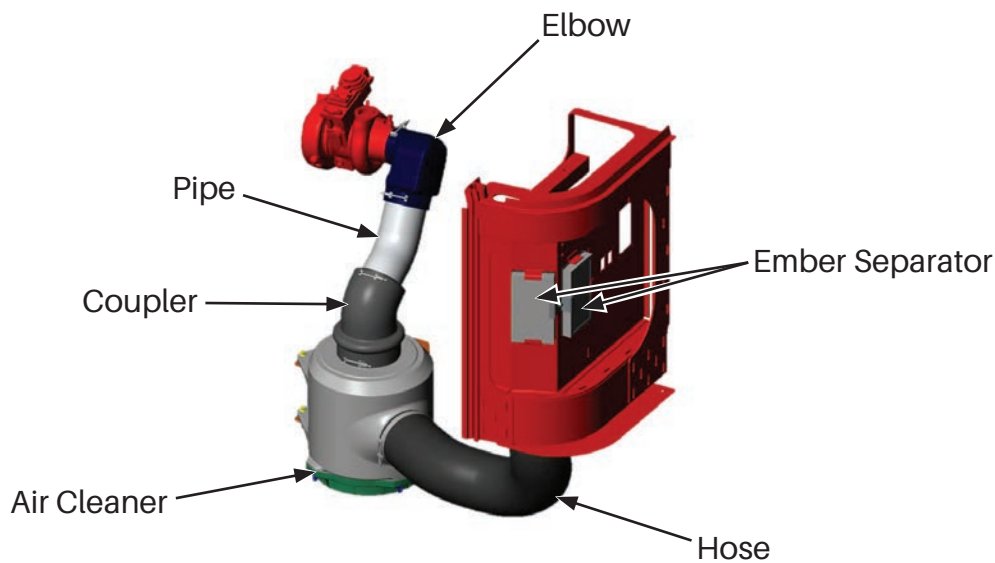

Figure 5-38. Typical Air Intake System - Conventional"

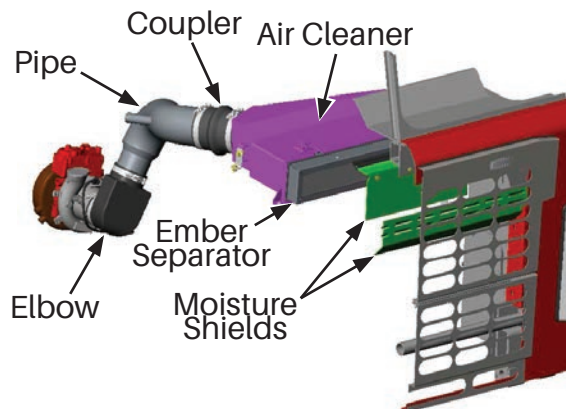

Figure 5-39. Typical Intake System - High Air

SERVICE PROCEDURES

External Air Inlet

Typical inlet passages include locations in the headlight bezel, grill, front tunnel wall, etc. to allow external air to enter the air intake system. The passages are designed for air restriction minimization, moisture removal, and temperature control.

NOTICE

Unacceptable engine inlet air quality, temperature or restriction may occur if changes are made to the external passages and/or if obstructions and contaminants are allowed to collect. Air quality, temperature or restriction beyond the maximum operating limits may result in loss of performance and engine damage.

WARNING

Do not use ether, propane, gasoline, or other starting aids when starting the engine. Serious personal injury can result from using starting aids.

The air inlet passages must be inspected regularly to remove foreign material that restrict air movement into the air intake. Additionally, air recirculation shields, and seals, located in the passages must be inspected regularly, and maintained to control air inlet temperature by restricting the intrusion of hot air under the cab, back into the engine.

Moisture Shields (If Equipped)

The moisture shields are positioned to redirect and separate moisture from external air prior to entering the air filter. They are located behind the grill and account for a minimum inlet air restriction.

WARNING

The removal, modification, unapproved replacement, and/or allowed obstruction of the moisture shields may result in loss of performance and engine damage.

The moisture shields must be inspected regularly and routine cleaning may be required in high dust/debris environments to remove obstructions or contaminants. Additionally, moisture shield seals must be regularly inspected to ensure that they are not being bypassed. If replacement is necessary, original replacement parts are required to avoid restriction issues.

Ember Separator

The ember separator is a minimum restriction mesh screen that traps hot embers and allows them to extinguish prior to reaching the air filter. Conventional air intake systems locate the ember separator behind the officer side headlight. High air intake systems locate the ember separator in front of the air cleaner housing.

WARNING

The removal, unapproved replacement, allowed obstruction, and/or contamination of the ember separator may result in loss of performance and engine damage. Hot embers reaching the air filter may result in a fire.

The ember separator must be inspected regularly and routine cleaning may be required in high dust/debris environments to remove obstructions or contaminants. Additionally, the ember separator seals **must** be regularly inspected to ensure that they are not being bypassed. If replacement is necessary, original replacement parts are required to avoid restriction issues.

Air Cleaner

The vehicle has an air cleaner housing with replaceable filter element that provides maximum protection against contaminated air entering the engine. The air cleaner is located under the cab.

NOTICE

Replacement with unapproved air cleaners or filter elements, and/or contamination of the turbo inlet or air cleaner during replacement may result in loss of performance and engine damage.

Fording water and running over debris may cause damage to the air cleaner and loss of performance as well as engine damage. Punctures, or seal damage, may allow contaminant to enter the engine and cause serious damage.

When air cleaner or filter element replacement is necessary, original replacement parts are required to avoid filtration performance and/or restriction issues. The air cleaner housing **must** be inspected regularly for damage, at which time damage assessment may require replacement. Housing damage such as seal failure and punctures require immediate replacement and assessment of further engine damage. Additionally, excessive air filter restriction is indicated with a warning light on the instrument panel cluster requiring replacement of the air cleaner. Failure to replace a clogged air cleaner may result in loss of performance and engine damage. Air cleaner mounting bracketry and hardware **must** be routinely inspected and maintained for reliable mounting.

Air Intake Plumbing

Air inlet plumbing consists of tubes, couplers, hoses, elbows, and clamps necessary to move fresh air from the ember separator through the air cleaner into the turbo. Regular inspection and maintenance of the plumbing is necessary for overall performance of the air intake system. Clamps **must** be routinely inspected to ensure joints between components are tight to prohibit leaks and contamination. Tubes, couplers, hoses, and elbows must be routinely inspected for cracks, wear points, loose connections or punctures that can cause leaks. Failure to replace a damaged plumbing component may result in loss of performance and engine damage.

COOLING SYSTEM

NOTICE

Modifications to the chassis cooling systems, engine cooling systems, auxiliary coolant (outside of what is provided with this chassis), charge air cooling system, airflow system, and/or transmission cooling system are strictly prohibited without approval from E-One Engineering and the engine manufacturer. Modifications may result in loss of performance, emissions compliance violations, and/or void warranty.

The cooling system provides a means to dissipate heat produced by the engine and transmission, allowing them to operate at acceptable temperatures. Cooling systems include engine cooling, charge air cooling, and transmission cooling. [Figure 5-40](#) and [Figure 5-41](#) illustrate typical cooling systems.

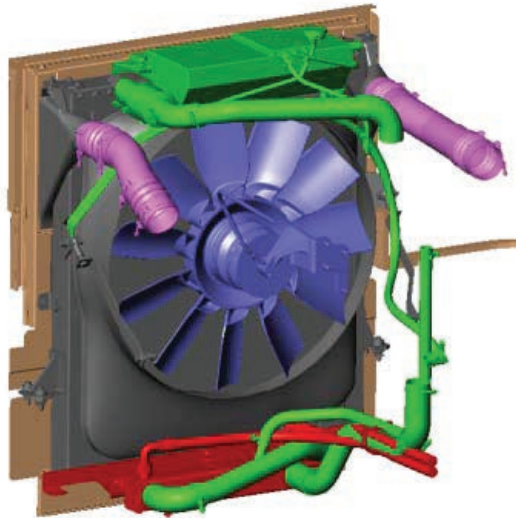

Figure 5-40. Typical Cooling System - Integrated Expansion

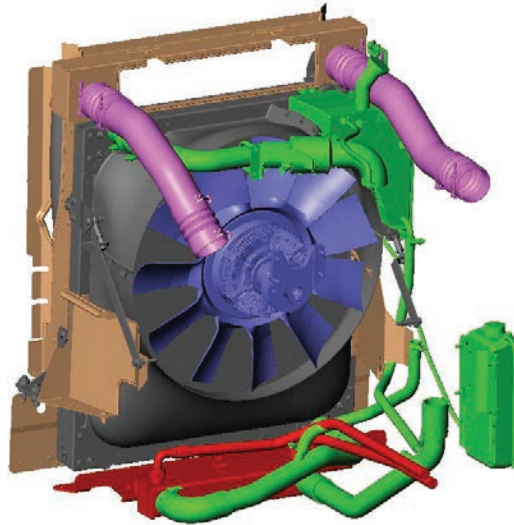

Figure 5-41. Typical Cooling System - Overflow Bottle Expansion

A properly designed and maintained engine cooling system is critical to the durability and performance of the engine. Internal combustion engines create heat during operation as fuel is ignited during the combustion process. The engine cooling system (Refer to [Figure 5-41](#) and [Figure 5-43](#)) removes heat from the engine and transfers it to the atmosphere through a complex arrangement of components to ensure reliable engine operation.

The engine manufacturer's Owners Manual, service and/or operations, and maintenance documentation **should** be referred to for all engine cooling systems operations, maintenance requirements, and service procedures to be performed. In addition to engine manufacturer's documentation, the following information is provided for E-One cab and chassis engine cooling system operation and maintenance.

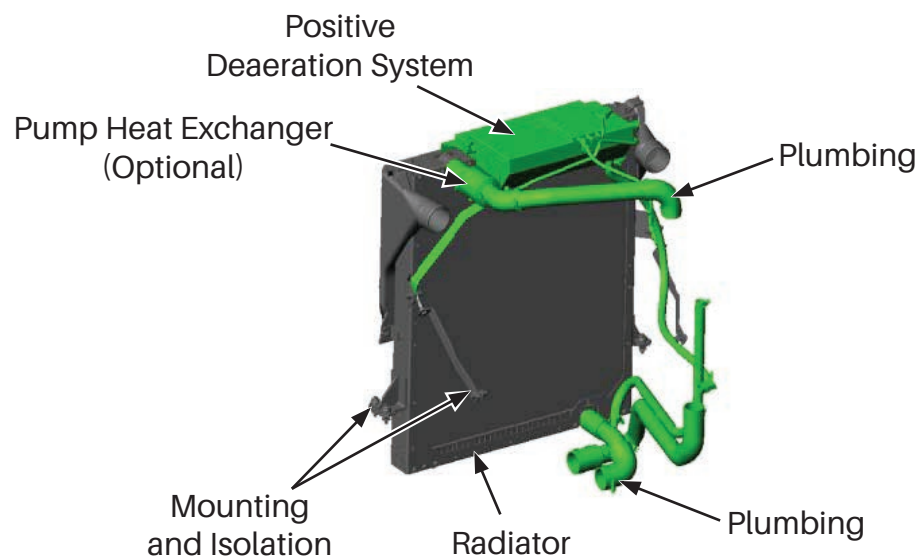

Figure 5-42. Typical Engine Cooling System - Integrated Expansion

SERVICE PROCEDURES

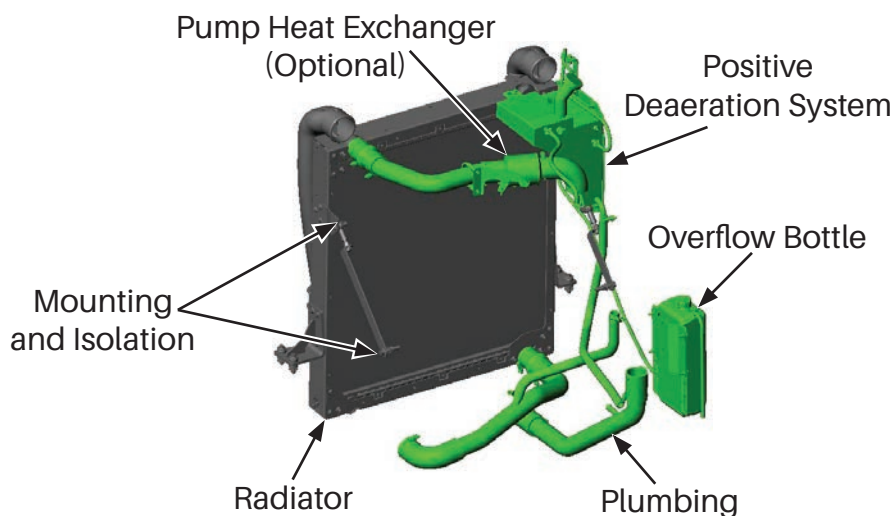

Figure 5-43. Typical Engine Cooling System - Overflow Bottle Expansion

Coolant Type

Coolant is the fluid that transfers the heat from the engine's components to the radiator for dissipation of heat to the atmosphere. Proper coolant is critical to the performance and durability of the engine. Refer to the engine manufacturer's documentation for proper selection, cautions and warnings. Refer to the data label above the sun visor for fluid type and quantity as provided by E-One.

NOTICE

The use of non-approved coolant types for the engine or improper coolant mixtures for the operating environment may result in engine damage.

Mixing coolant types may result in engine damage. If changes to the coolant type is needed a coolant flush is recommended.

Coolant Maintenance

Regularly maintained coolant and filters are critical to the performance and durability of the engine. Refer to the engine manufacturer's documentation for intervals required to check/maintain the coolant level, intervals to flush coolant, change filters, and procedures to service the coolant system. For both the integrated expansion and overflow bottle expansion cooling systems, coolant level checking is performed at the surge tank sight glass and coolant level filling is performed at the surge tank pressure cap. In the case of the overflow bottle expansion cooling system, the overflow bottle should be maintained at its cold full level. Drain ports are located at the bottom of the radiator and transmission cooler to remove the majority of the coolant. Coolant flushes may require the removal of plumbing to ensure all fluid is removed. After refilling the reservoir verify there are no leak paths.

NOTICE

Mixing coolant types may result in engine damage. If changes to the coolant type is needed a coolant flush is recommended.

Failure to maintain appropriate engine coolant mixture could result in emissions critical component failure.

WARNING

Electric shock is possible when performing maintenance with the ignition on. Serious personal injury can occur from electrical shock.

Coolant is toxic. Keep away from children and pets. If not reused, dispose of in accordance with local environmental regulations.

Coolant components and other engine components can be very hot if serviced shortly after operation. Serious personal injury can occur if hot components are touched.

Never remove radiator cap while coolant is hot. Remove cap slowly when coolant is at ambient temperature. A sudden release of pressure from a heated cooling system can result in serious personal injury from burst of hot coolant.

Positive Deaeration System

The surge tank and associated components (Refer to [Figure 5-44](#) and [Figure 5-45](#)) are utilized to indicate low coolant level, provide positive coolant pressure to the engine water pump, remove air from the coolant, and allow for coolant expansion and recovery.

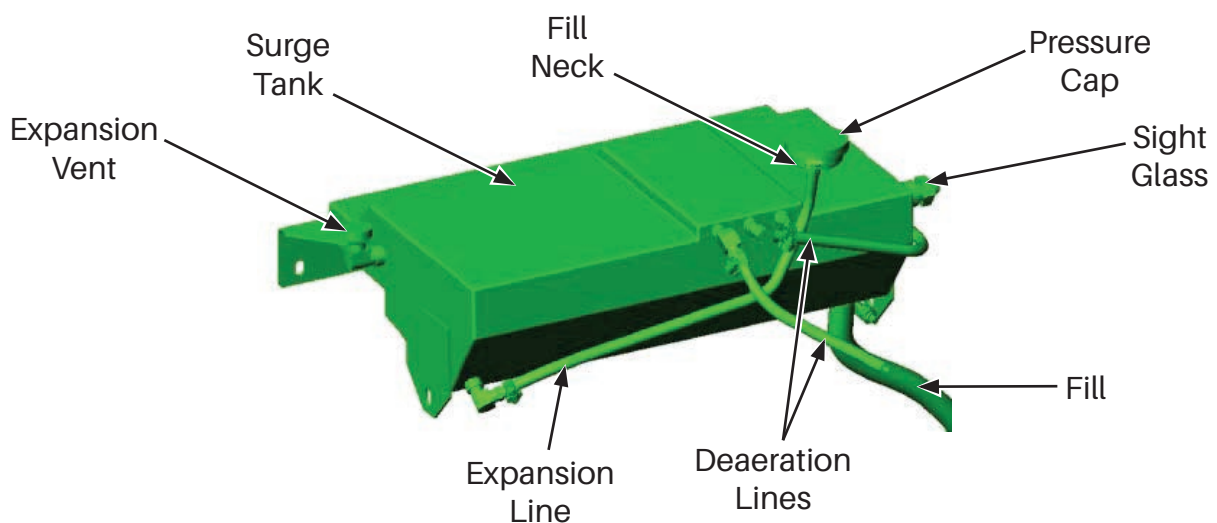

Figure 5-44. Typical Positive Deaeration System - Integrated Expansion

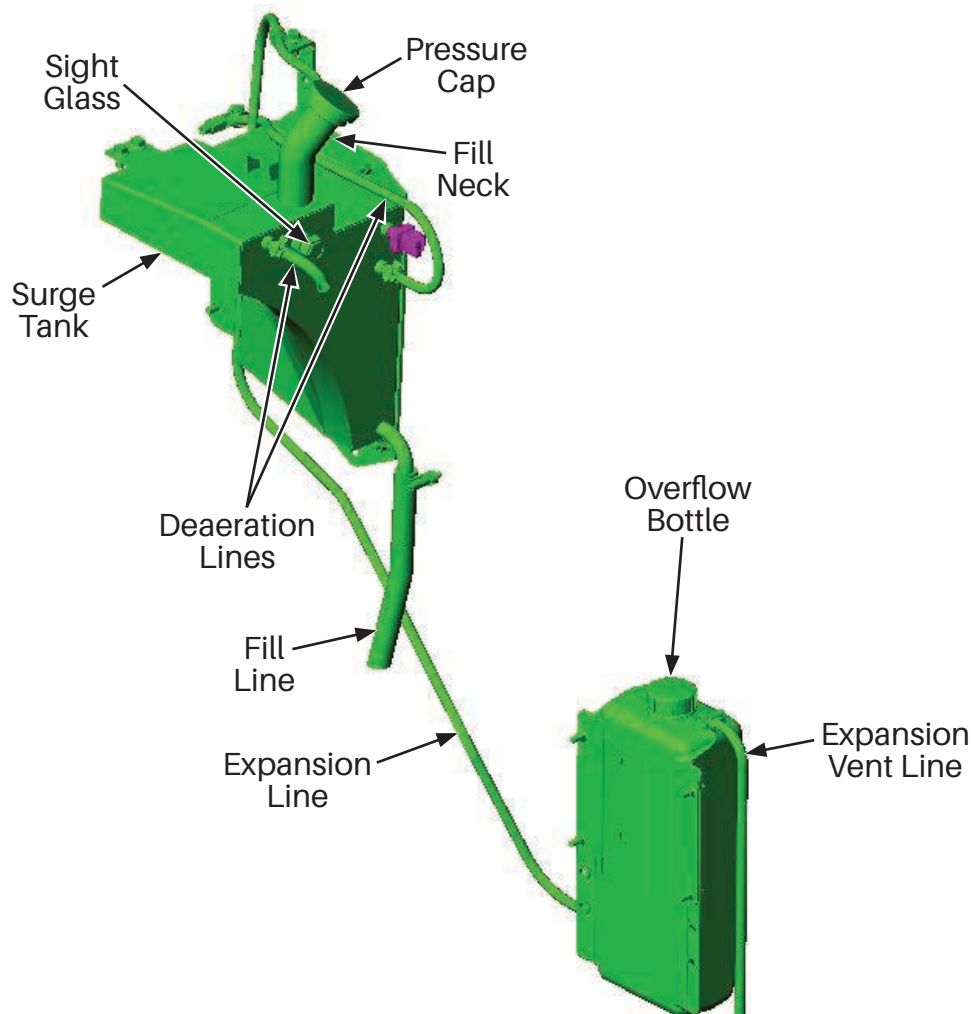

Figure 5-45. Typical Positive Deaeration System - Overflow Bottle Expansion

Surge Tank

The integrated expansion system surge tank is designed to contain both a pressure and expansion chamber (Refer to [Figure 5-46](#)). The pressure chamber contains the coolant full level when the system is not under pressure due to high temperature. As the coolant temperature and pressure rises, coolant is allowed out the fill neck by the pressure cap through the expansion line and into the expansion chamber. When the coolant temperature and pressure decreases, the coolant is then drawn back through the expansion line back into the pressure chamber to maintain a full system.

If an overflow bottle is used with the integrated expansion system as a safeguard to the environment, the fluid level in the overflow bottle shall not be used to visually determine coolant level. An overflow bottle that has increased in volume without drawing down when the system is cool and not under pressure, indicates a system issue and requires attention.

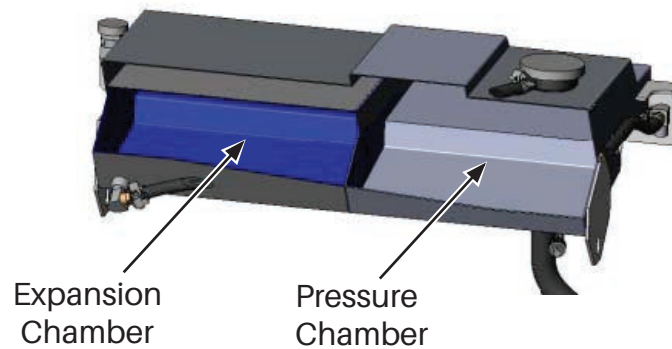

Figure 5-46. Typical Integrated Expansion Surge Tank Cutout

The overflow bottle expansion system surge tank is designed with only a pressure chamber (Refer to [Figure 5-45](#)). The pressure chamber sight glass is the absolute minimum cold coolant full level when the system is not under pressure due to high temperature. As the coolant temperature and pressure rises, coolant is allowed out the fill neck by the pressure cap through the expansion line and into the overflow bottle. When the coolant temperature and pressure decreases, the coolant is then drawn back through the expansion line back into the pressure chamber to maintain a full system. In the overflow bottle expansion system, the overflow bottle contains the minimum recommended cold coolant full level when the system is not under pressure due to high temperature. The overflow bottle can be viewed through the wheel well allowing the coolant level to be assessed while the cab is down and the system is not under pressure due to high temperature. An overflow bottle that has increased in volume without drawing down when the system is cool and not under pressure, indicates a system issue and requires attention.

Coolant Sight Glass

A sight glass is located on the surge tank, indicating the physical coolant level. If coolant is not visible in the sight glass, coolant fill is required. If coolant is not visible in the sight glass, but exists in the overflow bottle after the system is cool and not under pressure, inspection of the coolant pressure cap, fill neck interface, expansion line, etc... for vacuum leaks is necessary for proper repair

Coolant Low Level Indicator

An electronic indicator is located on the surge tank, indicating the low coolant level. A low coolant level is indicated with a warning light on the instrument panel cluster requiring coolant maintenance. Failure to maintain the proper coolant level may result in loss of performance and engine damage. If the electronic indicator is to be replaced or removed for maintenance purposes, it shall be reinstalled as follows:

- Lightly hand tighten
- Use the sensor hex area and torque to 26 in. lbs. (+/- 1 in. lbs.),
- Torque clock the sensor 1/2 to 3/4 of a turn so that the 3-pin connector is in vertical position (refer to [Figure 5-47](#)).

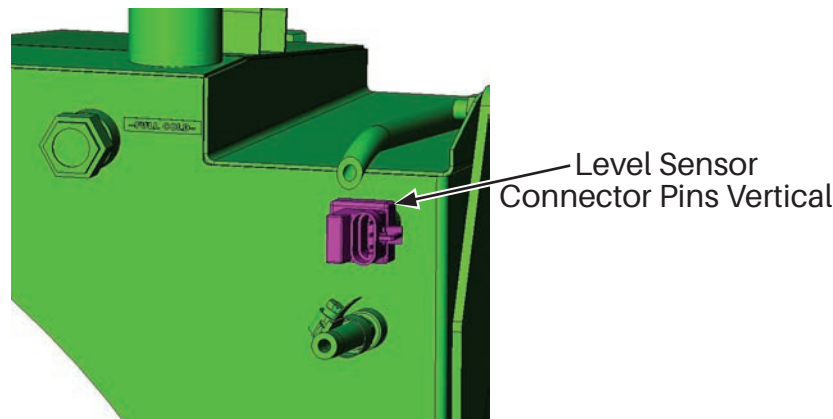

Figure 5-47. Coolant Low Level Indicator Orientation

De-Aeration Lines

De-aeration lines are routed from high points on the engine and radiator to the surge tank, allowing trapped air to be removed from the coolant during maintenance flushes and normal operation. Regular inspection and maintenance of the de-aeration lines is necessary for overall performance of the cooling system. Clamps and fittings must be routinely inspected to ensure joints between components are tight to prohibit leaks. Hoses must be routinely inspected for cracks, wear points, loose connections or punctures that may cause leaks. Failure to replace any damaged de-aeration lines may result in loss of performance and engine damage.

Coolant Fill Neck

The fill neck is located on the surge tank, allowing for coolant level maintenance, and allowing expansion and recovery of coolant during normal operation through the expansion line. Fill necks must provide proper sealing to the pressure cap. Refer to the engine manufacturer's documentation for intervals required to inspect the pressure cap sealing capability while installed on the surge tank fill neck. Improper pressure cap sealing can result in loss of coolant and may result in low coolant level, loss of performance and engine damage.

Coolant Pressure Cap

A dual seal pressure cap is located on the surge tank fill neck, allowing for coolant level maintenance, expansion, and recovery of coolant during normal operation. Pressure caps must be properly maintained for dependable operation. Pressure caps outside of proper pressure specification, cracks on the rubber seals, or improper sealing to the fill neck found during inspection will indicate the pressure cap must be replaced. Refer to the engine manufacturer's documentation for intervals required to inspect the pressure cap seals, procedures to test the pressure cap's rated pressure capability, and sealing capability while installed on the surge tank. If pressure cap replacement is necessary, original replacement parts are required to avoid operational issues. An incorrect or malfunctioning pressure cap can result in loss of coolant and may result in low coolant level, loss of performance and engine damage.

Coolant Expansion Line

The expansion line allows for coolant to travel between the pressure chamber and expansion chamber during normal operation. Regular inspection and maintenance of the expansion line is necessary for overall performance of the cooling system. Clamps and fittings must be routinely inspected to ensure joints between components are tight to prohibit leaks. Hoses must be routinely inspected for cracks, wear points, loose connections, or punctures that can cause leaks. Failure to replace any damaged or leaking expansion lines may result in loss of coolant and may result in low coolant level, loss of performance and engine damage.

Coolant Expansion Vent / Vent Line

A vent and/or vent line is located on the expansion chamber of the positive de-aeration system, allowing for expansion of coolant during normal operation. The vent and/or vent line must be inspected regularly and routine cleaning may be required in high dust/debris environments to remove obstructions or contaminants.

Coolant Fill Line

The fill line allows for coolant to migrate throughout the entire cooling system during filling operation. Pressurized coolant from the surge tank is provided to the pressure chamber then to the engine water pump in order to prevent pump cavitation during normal operation. Regular inspection and maintenance of the fill line is necessary for overall performance of the cooling system. To detect/or prevent leaks, clamps and fittings must be inspected for tightness. Hoses must be routinely inspected for cracks, wear points, loose connections or punctures that can cause leaks. Failure to replace any damaged or leaking fill lines may result in loss of coolant, reduced performance, and engine damage.

Radiator

The radiator is a critical component of the engine cooling system and is sized and configured to cool the engine properly. The engine pumps hot coolant into the radiator. As the hot coolant passes through the radiator, the engine fan draws ambient air through the radiator grid in turn transferring the heat from the coolant to the air. For this reason, the radiator is considered an air-to-coolant cooler. The coolant is then returned back to the engine to remove more generated heat and repeat the cycle. The typical mounting location for the radiator is behind the grill and in front of the engine fan.

NOTICE

Coolant temperatures may elevate beyond normal operating ranges if obstructions are added in front of the radiator, contaminants are allowed to collect on the radiator or damaged cooling fins exist. Coolant temperatures beyond the maximum operating temperatures may result in loss of performance and/or engine damage.

Regular inspection of the radiator is necessary for overall performance of the cooling system. The radiator must be maintained so the cooling grid is clean and free of contaminants, otherwise coolant overheating may occur. Clean, low pressure water flushed through the cooling fins, and a soft brush to remove debris is recommended for cleaning.

NOTICE

The use of high-pressure air, high-pressure water, and/or caustic cleaning solutions may damage the radiator causing premature failure or excessive coolant temperatures.

Radiator Mounting and Isolation

The radiator is mounted to the chassis and isolated from shock and vibration. Regular inspection and maintenance of the mounting and isolation components is necessary for overall durability of the cooling system. Fasteners and brackets **must** be routinely inspected to ensure the cooling system is properly secured. Isolation components **must** be routinely inspected for cracks, wear points and loose connections that allow for excessive movement or interference during operation. Failure to replace any damaged mounting or isolation may result in failure of critical cooling system components.

Pump Heat Exchanger (If Equipped)

Pump heat exchangers may be present in a cooling system to maintain proper engine coolant temperatures during pump mode operation. The typical mounting location for the pump heat exchanger is between the engine and the radiator coolant inlet. Water from the apparatus pump is routed through the pump heat exchanger during pump mode operation to provide additional cooling to the engine coolant. Pump heat exchanger ports and water lines **must** be configured so water is not allowed to freeze thus damaging the components.

Routine inspection of the pump heat exchanger is necessary to check for adverse wear or failure. Failure to replace a damaged pump heat exchanger may result in loss of coolant or weakening of the coolant mixture resulting in loss of performance and/or engine damage.

Coolant Plumbing

Coolant plumbing consists of the tubes, hoses, and clamps necessary to move the coolant through the cooling system loop during engine operation. Regular inspection and maintenance of the plumbing is necessary for overall performance of the engine cooling system.

Clamps **must** be routinely inspected to ensure joints between components are tight to prohibit leaks and contamination.

Tubes and hoses **must** be routinely inspected for cracks, wear points, loose connections, or punctures that can cause leaks.

Failure to replace a damaged plumbing component may result in loss of performance and engine damage.

Charge Air Cooling System

A properly designed and maintained charge air cooling system is critical to the durability and performance of the engine. Turbocharged engines elevate temperature and pressure of the intake air during the mechanical operation of the turbocharger. The charge air cooling system (Refer to [Figure 5-48](#)) removes this heat from the intake air and transfers it to the atmosphere to ensure reliable engine operation.

The engine manufacturer's Owners Manual, service and/or operations and maintenance documentation should be referred to for all charge air cooling systems operations, maintenance requirements, and service procedures to be performed. In addition to engine manufacturer's documentation, the following information is provided for E-One charge air cooling system operation and maintenance.

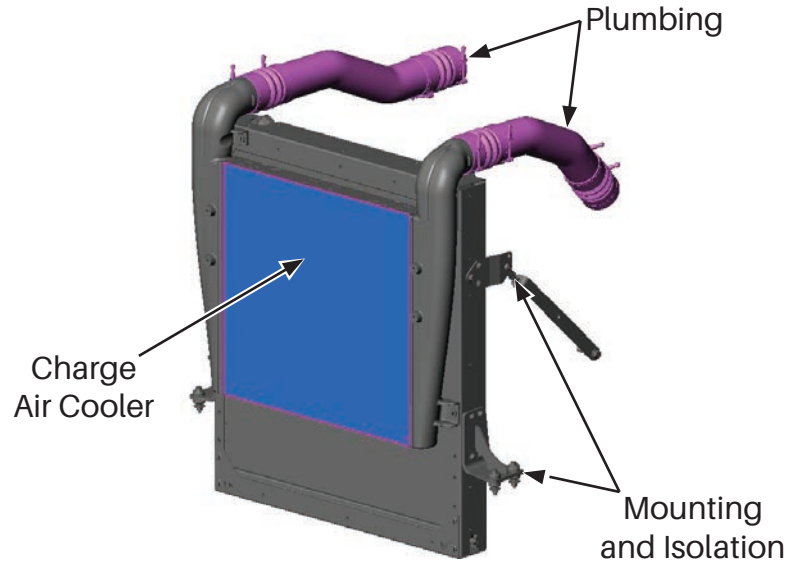

Figure 5-48. Typical Charge Air Cooling System

Charge Air Cooler

The charge air cooler is an emissions critical component that is sized and configured to cool turbocharged air prior to being used by the engine. The turbocharger elevates the temperature and pressure of the clean air coming from the air cleaner. As the hot air passes through the charge air cooler, the engine fan draws ambient air through the charge air cooler grid in turn transferring heat from the internal air to the atmospheric air. For this reason, the charge air cooler is considered an air-to-air cooler. The cooled air is then returned back to the engine to be utilized during the combustion process. The typical mounting location for the charge air cooler is behind the grill and in front of the radiator.

NOTICE

Engine intake air temperatures may elevate if obstructions are added near the charge air cooler, contaminants are allowed to collect on the charge air cooler, or damaged cooling fins exist. Engine intake air temperatures beyond the maximum operating temperatures may result in loss of performance and engine damage.

Regular inspection of the charge air cooler is necessary for overall performance of the charge air cooling system. The charge air cooler **must** be maintained so the cooling grid is clean and free of contaminants, otherwise engine intake air overheating may occur. Clean, low pressure water flushed through the cooling fins, and a soft brush to remove debris is recommended for cleaning.

NOTICE

The use of high-pressure air, high-pressure water, and/or caustic cleaning solutions may damage the charge air cooler causing premature failure or intake air overheating.

Contamination of the charge air cooler during service or replacement may result in loss of performance and engine damage.

SERVICE PROCEDURES

Charge air cooler Mounting and Isolation

The charge air cooler is mounted to the radiator and isolated from shock and vibration. Regular inspection and maintenance of the mounting and isolation components is necessary for overall durability of the cooling system. Fasteners and brackets must be routinely inspected to ensure the cooling system is properly secured. Isolation components must be routinely inspected for cracks, wear points and loose connections that allow for excessive movement or interference during operation. Failure to replace any damaged mounting or isolation may result in failure of critical cooling system components.

Charge Air Plumbing

Charge air plumbing consists of the tubes, hoses, and clamps necessary to move the air from the turbo through the charge air cooler and into the engine air intake manifold. Regular inspection and maintenance of the plumbing is necessary for overall performance of the charge air cooling system. Clamps **shall** be routinely inspected to ensure joints between components are tight to prohibit leaks and contamination. Tubes and hoses **shall** be routinely inspected for cracks, wear points, loose connections or punctures that can cause leaks. Failure to replace a damaged plumbing component may result in loss of performance and engine damage.

NOTICE

Contamination of charge air plumbing during service or replacement may result in loss of performance and engine damage.

Airflow System

A clean, temperature regulated source of air into the radiator and charge air cooler are essential to proper operation. Additionally, the air **must** move efficiently through the coolers and properly dispense into the engine tunnel without preheating incoming air or stagnating in the tunnel. Typical airflow systems (Refer to [Figure 5-44](#) and [Figure 5-45](#)) consist of all components needed to maintain the air source through the radiator and charge air coolers.

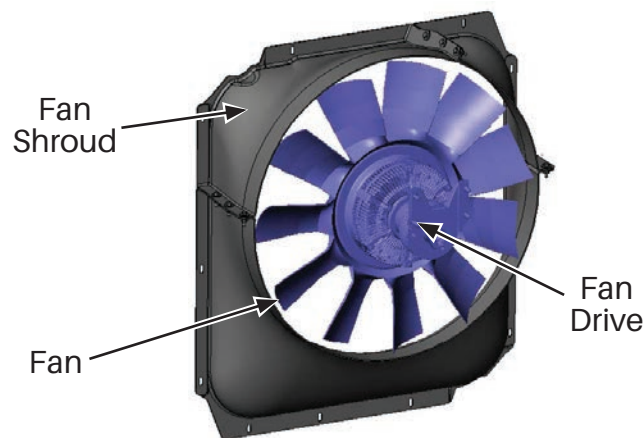

Figure 5-49. Typical Fan Drive and Shroud

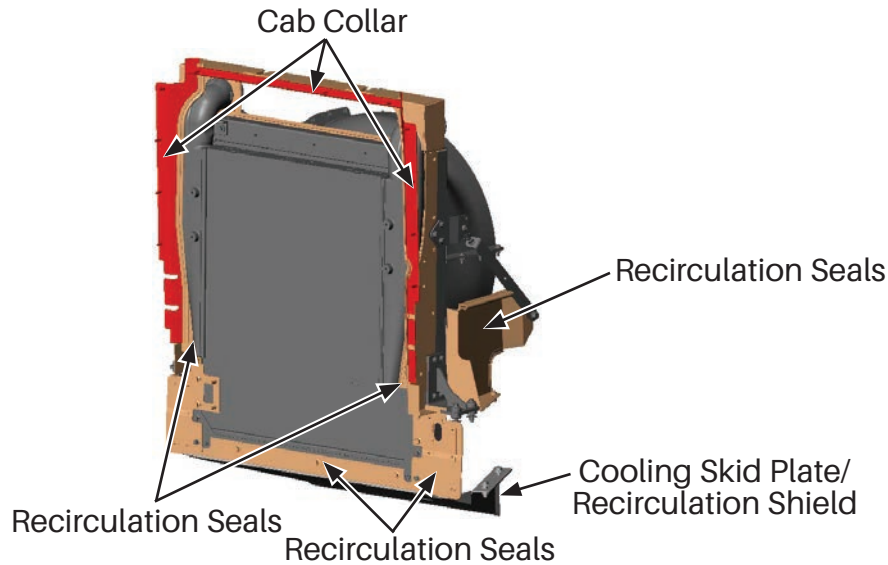

Figure 5-50. Typical Airflow Recirculation Shielding

External Air Inlet

Typical inlet passages include locations in the headlight bezel, grill, front tunnel wall, etc. to allow external air to enter the air intake system. The passages are designed for air restriction minimization, moisture removal, and temperature control.

NOTICE

Unacceptable engine inlet air quality, temperature or restriction may occur if changes are made to the external passages and/or if obstructions and contaminants are allowed to collect. Air quality, temperature or restriction beyond the maximum operating limits may result in loss of performance and engine damage.

The air inlet passages must be inspected regularly to remove obstructions or contaminants that restrict air movement into the charge air and radiator coolers.

Recirculation Shields/Seals

Recirculation shields, seals and adjoining components form a positive barrier between the hot engine compartment air and the ambient inlet air to the charge air and radiator coolers. As air passes through the charge air and radiator coolers, heat is transferred from the coolers to the air. The recirculation barrier limits the amount of hot engine compartment air mixing with the ambient inlet air, allowing the coolers to operate at optimal performance. Recirculation shields may consist of add on shields, plates and seals to block engine compartment airflow, as well as components that act as sealing surfaces. The cab collar acts as a positive seal to the cooling system when the cab is locked down. All recirculation shields, seals and sealing components **must** be regularly inspected and maintained to control air inlet temperature by restricting the intrusion of hot under cab air back into the coolers. Seals **must** be inspected for wear and required positive contact with recirculation shields or other components. Failure to replace missing, damaged or leaking recirculation shields and seals may result in loss of performance, and/or engine/ transmission damage.

SERVICE PROCEDURES

NOTICE

Increased charge air or coolant temperatures may occur if changes are made to the recirculation barrier components. Charge air and coolant temperatures beyond the maximum operating temperatures may result in loss of performance and engine/transmission damage.

Fan

The cooling system fan is located between the engine and cooling system pulling external ambient air through the radiator and charge air coolers into the engine compartment. The movement of air through the coolers is necessary for optimal performance of the coolers during engine operation. The fan **must** be routinely inspected to ensure proper clearance to the shroud and that no fan damage is present. Damaged fans must never be repaired. Failure to replace a damaged fan may cause serious damage during engine operation.

WARNING

Before inspecting fan, drive the engine must be turned "OFF".

Fan Drive

The fan drive is attached to the engine and rotates the fan via the engine accessory drive belt. The fan drive is clutched requiring the engine to send a signal for fan activation. Clutched configurations may be single (on/off) or variable speed types, and may be actuated via air, viscous, etc. Coolant temperature, engine temperature, etc... are factors in clutched fan drive operation. On/off configurations will only active the fan to full on or off given the current engine, transmission, fan drive and cooling requirements. Variable speed configurations will activate the fan to the appropriate speed given the current engine, transmission, fan drive and cooling requirements. The viscous variable speed fan drive may activate at full on after initial vehicle startup, but will deactivate to off with increased engine RPM. The fan drive **must** be routinely inspected to ensure that mounting hardware is tight, the pulley/belt is aligned properly and no drive wear is present. For clutched fan drives, proper activation and controls **must** be inspected and tested. Failure to replace a damaged fan drive may cause serious damage during engine operation.

Fan Shroud

Promotes efficient movement of air through the charge air and radiator coolers to the fan. The configuration of the fan, shroud, and cooler is important to the overall performance of the cooling system. Routine inspection of the fan shroud is necessary to ensure proper fan clearance and ensure shroud to cooler sealing. Failure to maintain proper fan to fan shroud clearance may cause serious damage during engine operation.

TRANSMISSION

All operators and owners should read the transmission operation manual before operating the vehicle. For complete transmission information, refer to the applicable manual.

Oil Check Procedure

Fluid level is critical to the transmission operation. Refer to the applicable manual to determine the appropriate method of obtaining the oil level reading.

Weekly, check transmission oil for contamination of water/glycol via the dipstick. The engine should be running for this inspection.

Diagnostic Incident Display Procedure

To check for diagnostic codes, be sure the vehicle is safely stopped, the park brake is activated, and the transmission is in neutral. Refer to the applicable manual for detailed explanation of accessing, viewing, and clearing code information.

Transmission Cooling System

A properly designed and maintained transmission cooling system is critical to the durability and performance of the transmission. Transmission fluid temperature is elevated during transmission operation. The transmission cooling system removes this heat from the transmission fluid and transfers it to the coolant to ensure reliable transmission operation. **Figure 5-51** illustrates a typical transmission sump cooling system. **Figure 5-52** illustrates a typical transmission sump and retarder combined cooling system.

The transmission manufacturer's Owners Manual, and other service related documentation should be referred to for requirements pertaining to maintenance, or service procedures for the transmission and/or related systems. In addition to transmission manufacturer's documentation, the following information is provided for E-One transmission cooling system operation and maintenance

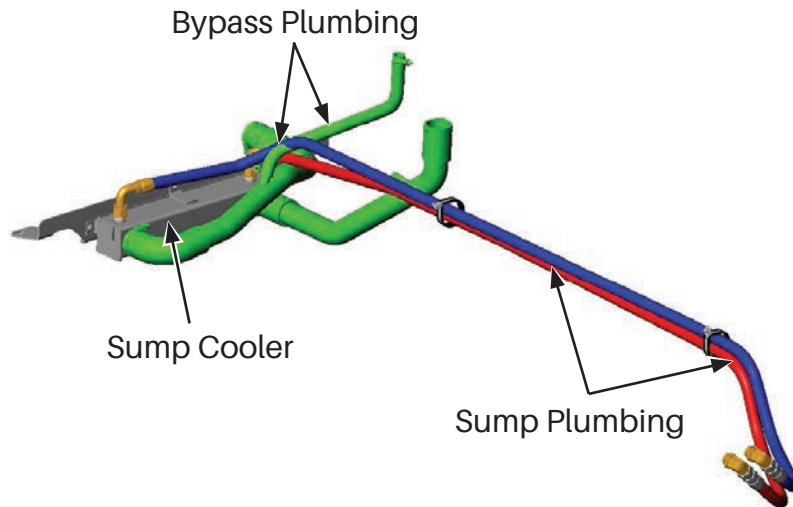

Figure 5-51. Typical Transmission Sump Cooling System

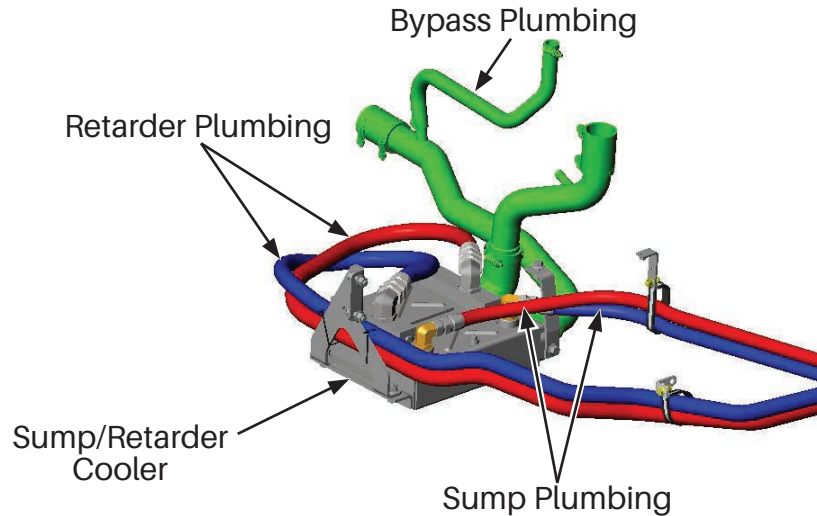

Figure 5-52. Typical Transmission Sump and Retarder Combined Cooling System

Transmission Fluid Type

Transmission fluid is the medium that lubricates the internal transmission components and transfers the heat from the transmission's components to the transmission cooler for dissipation of heat. Proper transmission fluid is critical to the performance and durability of the transmission. Refer to the transmission manufacturer's documentation for proper selection, cautions, and warnings. Refer to the data label above the sun visor for fluid type and quantity as provided by E-One.

NOTICE

The use of non-approved transmission fluid types for the transmission may result in transmission damage and void warranty.

Transmission Fluid Maintenance

Regularly maintained transmission fluid and filters are critical to the performance and durability of the transmission. Refer to the transmission manufacturer's documentation for intervals required to check/maintain the transmission fluid level, intervals to change transmission fluid and filters, and procedures for safely servicing the transmission.

Transmission Fluid Dipstick

The transmission fluid dipstick is used to manually check oil level to transmission requirements. The dipstick handle can be located in various locations based on application, ranging from access under the cab to remote access through a hatch.

Transmission Fluid Electronic Level Sensing

In applications where transmission fluid dipsticks cannot be accessed without tilting the cab, the transmission control pad can also be used to electronically monitor and check the transmission fluid level. This oil level sensing may not correlate exactly with the add mark on the dipstick, but is approved by the transmission manufacturer for use. Refer to the transmission manufacturer's documentation for electronic oil level checking and warnings.

Transmission Fluid Fill Port

The transmission fluid fill port is used to add transmission fluid as needed to bring the level on the transmission dipstick and/or control pad to proper operating range. The transmission fluid can be filled by removing the transmission dipstick and can be located in various locations based on application, ranging from access under the cab to remote access through a hatch.

Transmission Cooler

The transmission cooler is a critical component to proper operation of the transmission, and is sized appropriate to the transmission configuration. The transmission sends hot fluid into the transmission cooler. As the hot fluid passes through the transmission cooler the engine coolant in contact with internal cooler components transfers heat from the transmission fluid to the coolant. For this reason, the transmission cooler is considered an oil-to-coolant cooler. The transmission fluid is then returned back to the transmission to lubricate the transmission, remove more generated heat, and repeat the cycle. Typical mounting location for the transmission cooler is in the radiator coolant outlet plumbing between the radiator and the engine. Retarder and non-retarder transmission coolers differ in size and configuration as additional plumbing and heat rejection are required for the retarder application.

NOTICE

Transmission fluid temperatures may elevate above normal operating temperatures if obstructions are added near the radiator, contaminants are allowed to collect on the radiator, or damaged cooling fins exist. Transmission fluid temperatures beyond the maximum operating temperatures may result in loss of performance and transmission damage.

Regular inspection of the transmission fluid cooler is necessary to detect defects that degrade the performance of the transmission cooler. Inspect the cooler to ensure it is securely mounted and no external wear is occurring on the cooler.

NOTICE

Contamination of the transmission cooler during service or replacement may result in loss of performance and transmission damage.

SERVICE PROCEDURES

Transmission Bypass Plumbing

The transmission bypass line is required for coolant flow through the transmission cooler when the engine is not warm enough for normal coolant flow. When the engine is cool, the thermostat is closed, and coolant is not allowed to flow through the radiator. The bypass line allows coolant to bypass the thermostat directly to the transmission cooler coolant inlet plumbing. This allows the coolant flow to remove heat from the transmission fluid until the engine thermostat opens and normal coolant flow occurs. Regular inspection and maintenance of the bypass line is necessary for overall performance of the transmission. Clamps and fittings must be routinely inspected to ensure joints between components are tight to prohibit leaks. Hoses must be routinely inspected for cracks, wear points, loose connections, or punctures that can cause leaks. Failure to replace a damaged or leaking bypass line may result in loss of coolant and may result in loss of performance, and engine and/or transmission damage.

Transmission Plumbing

The transmission lines allow for transmission fluid to travel between the transmission and transmission cooler during normal operation. Regular inspection and maintenance of the transmission lines is necessary for overall performance of the transmission. Clamps and fittings must be routinely inspected to ensure joints between components are tight to prohibit leaks. Hoses must be routinely inspected for wear points or loose connections that can cause leaks. Failure to replace any damaged or leaking transmission lines may result in loss of transmission fluid and may result in loss of performance and transmission damage.

EXHAUST/AFTERTREATMENT SYSTEM

NOTICE

Modifications to the exhaust and/or aftertreatment system are strictly prohibited without approval from E-One Engineering and the engine manufacturer. Modifications may result in loss of performance, emissions compliance violations, and/or void warranty.

The exhaust/aftertreatment system moves exhaust gases from the engine to a suitable location on the vehicle while simultaneously cleaning the gases to environmental standards. Exhaust/aftertreatment systems include exhaust routing, aftertreatment, and tailpipe/temperature mitigation. [Figure 5-53](#) illustrates a typical exhaust/aftertreatment system.

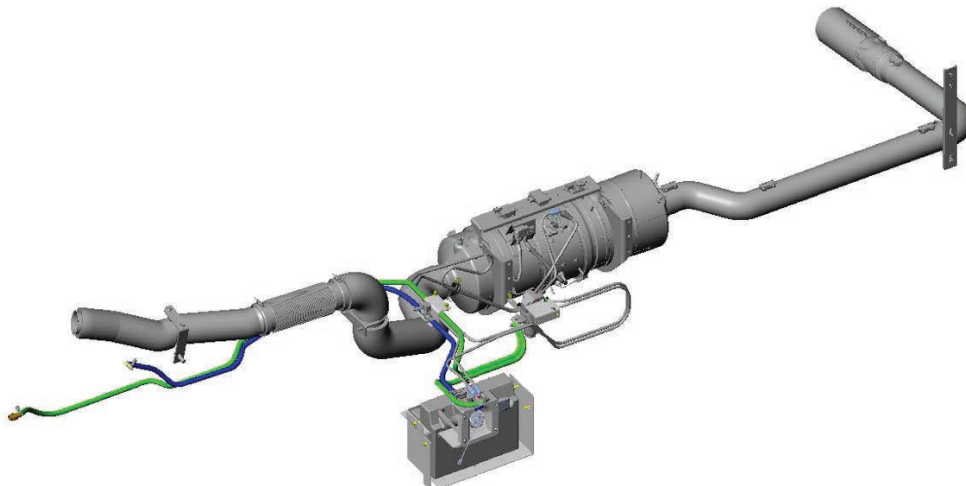

Figure 5-53. Typical Exhaust/DPF-SCR Single Module Aftertreatment System

Exhaust Routing

A properly designed and maintained exhaust routing system transfers exhaust gases from the engine to the aftertreatment system with minimum restriction to flow. **Figure 5-54** illustrates a typical exhaust routing system.

The engine manufacturer owner's Manual, service, and/or operations, and maintenance documentation **must** be referred to for all exhaust routing operations, maintenance requirements, and service procedures to be performed. Installation is certified with the engine manufacturer to follow all performance requirements and government regulations. In addition to the engine manufacturer's documentation, the following information is provided for E-One cab and chassis exhaust routing operation and maintenance.

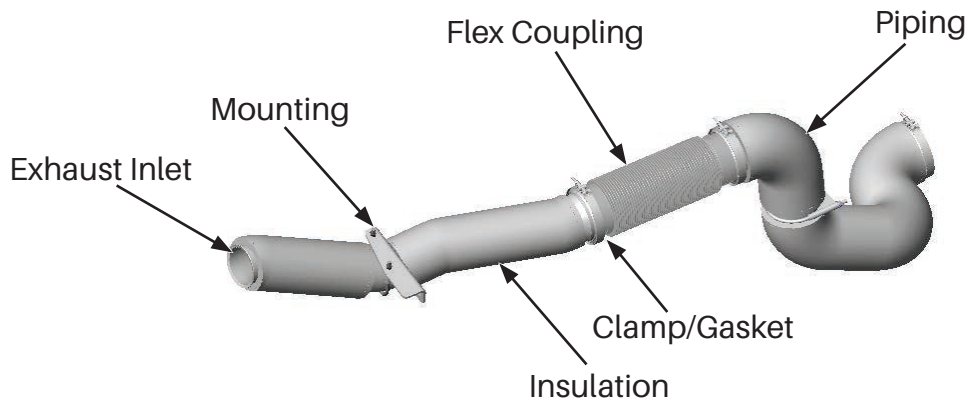

Figure 5-54. Typical Exhaust Routing

Piping

Piping routes the exhaust gases from the engine to the downstream exhaust/aftertreatment components. Piping is typically wrapped with insulation to control the internal exhaust temperature necessary for proper aftertreatment and also to reduce heat effects on surrounding vehicle components and systems. Regular inspection and maintenance of the piping and insulation is necessary for overall performance of the exhaust and aftertreatment system. Pipes and insulation **must** be routinely inspected for cracks, wear points, loose connections, or punctures that can cause leaks. Failure to replace damaged piping and insulation may result in loss of engine and aftertreatment performance.

Flex Coupling

The flex coupling is mounted between engine mounted and vehicle frame mounted piping to isolate engine vibration and movement from downstream exhaust components. Regular inspection and maintenance of the flex coupling is necessary for overall performance of the exhaust and aftertreatment components. The flex coupling **must** be routinely inspected for cracks, wear points, loose connections, or punctures that can cause leaks. Failure to replace a damaged flex coupling may result in loss of engine and aftertreatment performance and cause damage to downstream components.

SERVICE PROCEDURES

Mounting

V-band style clamps and gaskets are used to connect all routing components per engine manufacturer's standards. Piping is supported off the engine, transmission, and vehicle frame using brackets and u-clamps. All clamp torques should be checked regularly to verify proper sealing, support, and to check for damage. Regular inspection and maintenance of the clamps, gaskets and brackets is necessary for overall performance of the exhaust and aftertreatment system. Clamps **must** be routinely inspected to ensure joints between components are tight to prohibit leaks and contamination. Brackets **must** be routinely inspected for loose connections that can cause damage. Failure to replace a damaged mounting component may result in loss of engine and aftertreatment performance and cause exhaust damage.

Aftertreatment

A properly designed and maintained aftertreatment system filters and treats the exhaust gases to meet environmental standards before entering the atmosphere. **Figure 5-55** illustrates a typical DPF-SCR single module exhaust aftertreatment system.

The engine manufacturer owner's manual, service, and/or operations, and maintenance documentation **must** be referred to for all aftertreatment system operations, maintenance requirements, and service procedures to be performed. Installation is certified with the engine manufacturer to follow all performance requirements and government regulations. In addition to the engine manufacturer's documentation, the following information is provided for E-One cab and chassis aftertreatment operation and maintenance.

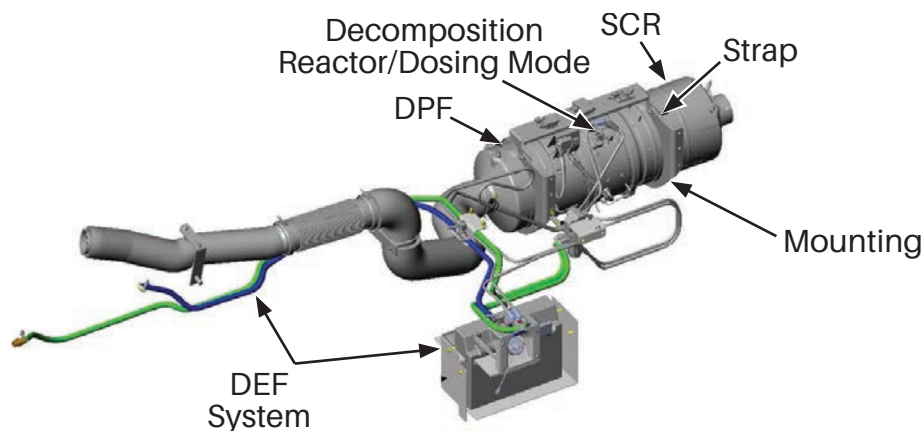

Figure 5-55. Typical DPF-SCR Single Module Exhaust Aftertreatment System

Diesel Particulate Filter (DPF)

The DPF is designed to remove particulate matter from the exhaust gases of a diesel engine. It is mounted directly downstream of the exhaust routing system. For filter regeneration and cleaning refer to engine manufacturer's recommendation.



When performing stationery regeneration make sure vehicle is safely off roadway and exhaust is away from people and any other flammable materials, vapors, or structures. During regeneration, exhaust gas temperature could reach 800°C (1500°F) and exhaust system surface temperature could exceed 700°C (1300°F).

D.P.F. Regeneration – When aftertreatment sensors detect the build-up of particulate matter in the D.P.F., the engine controller will take steps to clean the filter in a process called “Regeneration”. Regeneration involves elevating the exhaust temperature which can be initiated manually or automatically when the engine controller detects conditions are right.

Automatic D.P.F. Regeneration – When the engine controller determines regeneration is required it will initiate automatic regeneration if the engine is at operating temperature, and the vehicle speed is above 40 MPH. Automatic regeneration will cease when the vehicle speed drops below 24 MPH. Automatic regeneration will occur as needed when conditions allow without driver interaction. Elevating the duty cycle of the vehicle will aid in regeneration. Automatic regeneration can take between 20 and 60 minutes depending on the level of soot.

Manual D.P.F. Regeneration – When operating conditions do not allow for automatic regeneration, the regeneration process can be initiated manually with the “DPF MANUAL REGEN” switch (refer to the Electrical section for switch location). Use the following steps to initiate a manual regeneration:

1. Park the vehicle in a location where elevated exhaust temperatures will be acceptable.
2. Apply the park brake.
3. Place the transmission in neutral.
4. Ensure the engine is idling at normal operational temperature.
5. Press the “DPF MANUAL REGEN” switch.

NOTICE

Manual regeneration can only be initiated while the DPF Warning Lamp is on or flashing (see below).

During manual regeneration the engine speed will increase, the DPF Warning Lamp will turn off, and the High Exhaust System Temperature (HEST) lamp will turn on. When regeneration is complete, the engine will return to idle. This process can take between 20 and 60 minutes depending on the level of soot.

Manual regeneration may be cancelled at any time by turning the “DPF MANUAL REGEN” switch off, by pressing the “DPF REGEN INHIBIT” switch, or by depressing the brake or accelerator pedal.

D.P.F. Regeneration Inhibit Switch

When elevated exhaust temperatures cannot be allowed, automatic and manual regeneration may be temporarily disabled by pressing the “DPF REGEN INHIBIT” switch (refer to the Electrical section for switch location). When the inhibit switch is active, the “REGEN INHIBIT” lamp will be active.

Pressing the switch a second time or cycling the vehicle ignition switch will turn off the inhibit feature and allow regeneration to occur.

D.P.F. System Warning Lamps

Warning lamps in the instrument panel provide information to the driver regarding the state of the D.P.F. system.

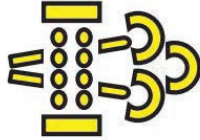

Figure 5-56. DPF Warning Lamp

DPF Warning Lamp - The DPF Warning Lamp notifies the driver when soot levels in the DPF require regeneration. A lamp that is illuminated constantly indicates regeneration should occur soon, and automatic regeneration will occur when conditions are right. Manual regeneration can also be initiated when this lamp is illuminated.

A flashing DPF Warning Lamp indicates soot levels are elevated, and the vehicle should be driven to allow automatic regeneration, or a manual regeneration cycle should be initiated as soon as possible.



Figure 5-57. Check Engine Lamp

Check Engine Lamp - If regeneration is not able to occur, and soot levels continue to rise, the Check Engine Lamp will turn on in conjunction with a flashing DPF Warning Lamp. This indicates a critical level of soot in the DPF and that manual regeneration should be performed as soon as possible. Continued operation without regeneration can lead to DPF damage and engine derating.



Figure 5-58. Stop Engine Lamp

Stop Engine Lamp - If regeneration does not occur, and the vehicle is operated with critical soot levels, damage to the DPF will occur. The DPF Warning Lamp will turn off and the Stop Engine Lamp will turn on, indicating the soot level is too high for regeneration. The vehicle requires immediate service and possible replacement of the DPF.



Figure 5-59. High Exhaust System Temperature Lamp

High Exhaust System Temperature (HEST) Lamp - This lamp indicates potentially exhaust temperatures. The lamp will illuminate when exhaust temperature is high or when a manual regeneration is in progress. Exercise caution around the tailpipe of the vehicle while this lamp is on.



Figure 5-60. Regeneration Inhibit Lamp

Regen Inhibit Lamp - This lamp indicates automatic and manual regeneration has been inhibited by the "REGEN INHIBIT" switch.

DPF Instruction Label

The following label is affixed to the driver's sun visor or under the hinged electrical access panel in the center of the dashboard. This provides a reminder of the DPF system operation.

CUMMINS

Diesel Particulate Filter (DPF) Regeneration Instructions

SPARTAN CUSTOMER SERVICE: 1-800-543-5008

REGENERATION PROCESS-ENGINE INDICATOR LIGHTS

	Indicator Lamp	LCD Text	Description	Driver Action
<p>Automatic Regeneration Procedure</p> <p>To initiate an automatic regeneration the DPF MANUAL REGEN switch must be in the OFF position, and the DPF REGEN INHIBIT switch must be in the OFF position. When vehicle speed exceeds 40 mph, automatic regeneration will be allowed until vehicle speed drops below 24 mph. Automatic regeneration will occur as needed when vehicle speed is sufficient and the engine is at operating temperature. Elevating the vehicle duty cycle aids in active regeneration. This procedure can take between 20 to 60 minutes depending on the level of soot.</p> <p>Manual / Parked Regeneration Procedure</p> <p>To initiate a manual regeneration the DPF lamp must be on or flashing. The engine should be at operating temperature and at low idle. Place the transmission in Neutral. Set the park brake. Switch DPF MANUAL REGEN switch to on position (engine speed will increase and the DPF Regeneration Lamp will go out). The HEST Lamp will illuminate. Once regeneration is complete the engine will return to idle. This procedure can take between 20 to 60 minutes depending on the level of soot. A manual regeneration can be aborted by tapping the brake or accelerator pedal.</p> <p>Inhibit Regeneration Procedure</p> <p>The regeneration process can be prevented or aborted if the vehicle's operation or environment requires regeneration NOT to occur. Regeneration should be disabled with the DPF REGEN INHIBIT switch for short periods of time only. The DPF REGEN INHIBIT will prevent both Automatic and Manual regeneration from occurring. When the DPF REGEN INHIBIT switch is pressed and the red light illuminates, REGEN INHIBIT is activated.</p>		Check Engine	Indicates a fault with the engine controls.	Vehicle can be operated until end of shift. Call for service.
		Stop Engine	Indicates a major engine fault that may result in engine damage. Fault should be identified immediately or severe engine damage could occur.	Move the vehicle to the nearest safe location and shutdown the engine. Call for service.
		Clean Diesel Particulate Filter	Soot illumination indicates a regeneration is required. Flashing indicates a manual regeneration should be initiated immediately. Lamp will shut off during manual regeneration.	Lamp Solid: Automatic/Manual regeneration required. Lamp Flashing: Automatic/Manual regeneration required.
		High Exhaust System Temperature (HEST)	The HEST lamp indicates potentially elevated exhaust temperatures. The lamp will illuminate when exhaust temperatures are high or when the vehicle is completing an automatic or stationary regen.	Continue to operate vehicle normally. Exercise caution around tailpipe.

Active engine faults may prevent an Automatic or Manual regeneration from occurring. Check for active faults and correct as necessary.

Soot accumulates in filter over time →

WARNING: Failure to follow instructions may result in loss of engine power, vehicle speed, increased exhaust temperatures, and may cause property damage, personal injury or death. When performing a stationary regeneration make certain vehicle is safely off roadway and exhaust is away from people and any other flammable materials, vapors or structures.

Figure 5-61. DPF Instruction Label

SERVICE PROCEDURES

Decomposition Reactor/Dosing Module

The decomposition reactor is mounted between the DPF and SCR in the DPF-SCR single module. Mounted to the outside of the decomposition reactor is the dosing module which injects the DEF into the exhaust stream to allow mixing before entering the SCR.

Selective Catalytic Reduction (SCR)

The SCR is mounted downstream of the decomposition reactor in the DPF-SCR single module. It contains a catalyst which uses the ammonia contained in the DEF to react with the exhaust gas NOx to form nitrogen and water.

Diesel Exhaust Fluid (DEF) System

The DEF system is a network of lines, fittings, valves and controllers that control and inject DEF into the exhaust stream to work with the SCR and complete the aftertreatment process. **Figure 5-62** shows a typical DEF system.

NOTICE

Modifications to the DEF circuit and/or use of DEF that does not meet ISO 22241-1 are strictly prohibited without approval from E-One Engineering and the engine manufacturer. Modifications may result in loss of performance, emissions compliance violations, and/or void warranty.

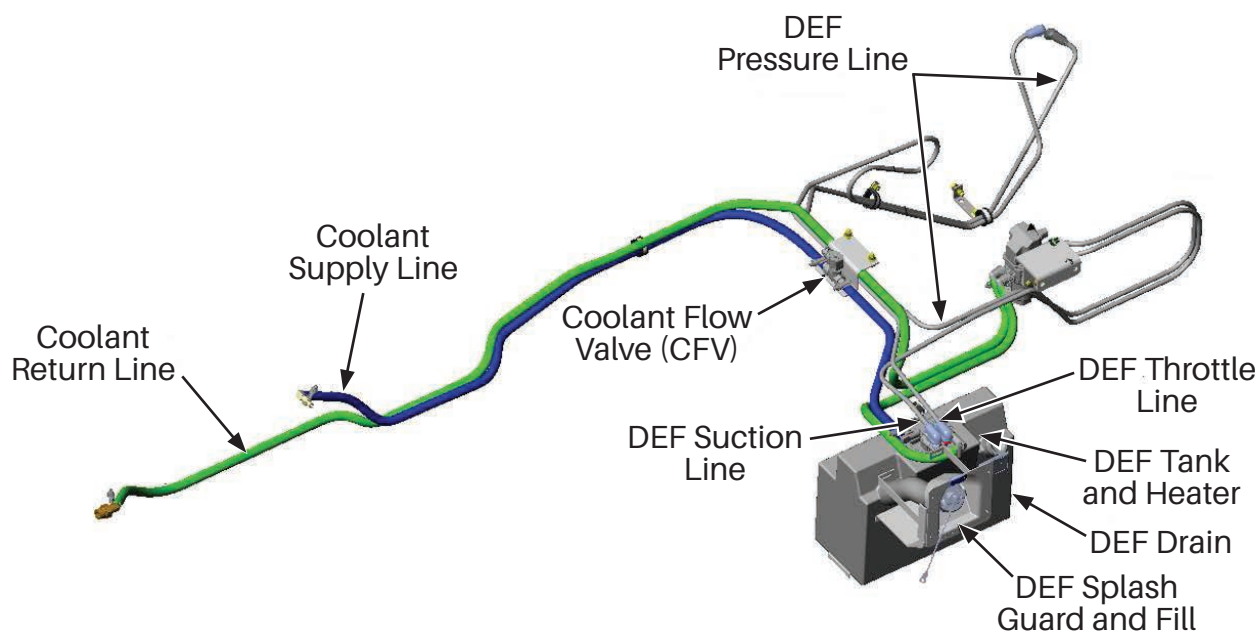

Figure 5-62. Typical Diesel Exhaust Fluid System

Diesel Exhaust Fluid (DEF) Type

DEF is a mixture of urea and water used in SCR aftertreatment systems. DEF can degrade due to environmental conditions and should be inspected frequently to determine quality. The engine manufacturer owner's manual **should** be referred to for DEF requirements and information. DEF is mostly water and depending on vehicle operating conditions, an integrated tank heater may be required to allow thawing.

DEF Tank/Heater

The DEF tank retains the diesel exhaust fluid and **must** be maintained according to engine manufacturer standards. Tanks are typically mounted inside the driver side battery box. The DEF tank must allow for freeze/thaw cycling as fluid temperature is only regulated during engine operation.

NOTICE

DO NOT overfill DEF tank. Proper fill level necessary to allow fluid expansion due to operating conditions and environmental factors. Immediately rinse with water and clean up any spilled DEF liquid.

Supply Module

The supply module is mounted to the vehicle frame and contains an electronically operated pump that delivers a controlled amount DEF to the dosing module.

Coolant Lines/Fittings

DEF coolant lines and fittings circulate engine coolant throughout the DEF system. During engine operation, coolant is constantly supplied to the dosing module to maintain temperature per engine manufacturer specifications. During extreme weather conditions, coolant is regulated to the DEF tank heater to prevent freezing using a flow valve.

DEF Throttle, Suction, and Pressure Lines

The throttle and suction lines regulate the flow of DEF from the tank to the supply module. The pressure line is directly connected to the dosing module and transfers the required amount of fluid into the exhaust stream. All lines are electrically heated to prevent freezing in low temperature conditions.

Remote DEF Fill (If Equipped)

Vehicle configurations may require a remote fill location for the DEF tank due to cab style/length and body design. The remote fill will utilize the secondary rear fill location on the DEF tank which is shown in [Figure 5-63](#). The apparatus body builder will need to secure the splash guard to the body.

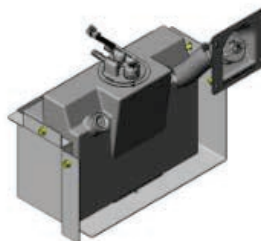

Figure 5-63. Remote Fill for Diesel Exhaust Fluid System

SERVICE PROCEDURES

DEF System Maintenance

The DEF tank volume is rated for the vehicle fuel tank size and the fluid level **must** be checked when refueling the vehicle. Regular inspection and maintenance of the DEF system is necessary for overall performance and emission compliance of the exhaust and aftertreatment system. Hose fittings and clamps **must** be routinely inspected to ensure connections between components are tight to prohibit leaks and contamination. Brackets **must** be routinely inspected for loose connections that can cause damage. Failure to replace a damaged mounting component may result in loss of engine and aftertreatment performance.

Mounting

Brackets and straps are used to secure the DPF -SCR single module to the vehicle frame. Straps are attached to specific areas on the single module determined by the engine manufacturer. V-band style clamps and gaskets are used to connect the single module to the exhaust piping. All clamp torque should be checked regularly to verify proper sealing, support, and check for damage. Regular inspection and maintenance of the clamps, gaskets and brackets are necessary for overall performance of the exhaust and aftertreatment system. Clamps **must** be routinely inspected to ensure joints between components are tight to prohibit leaks and contamination. Brackets **must** be routinely inspected for loose connections that can cause damage. Failure to replace a damaged mounting component may result in loss of engine and aftertreatment performance and cause exhaust damage.

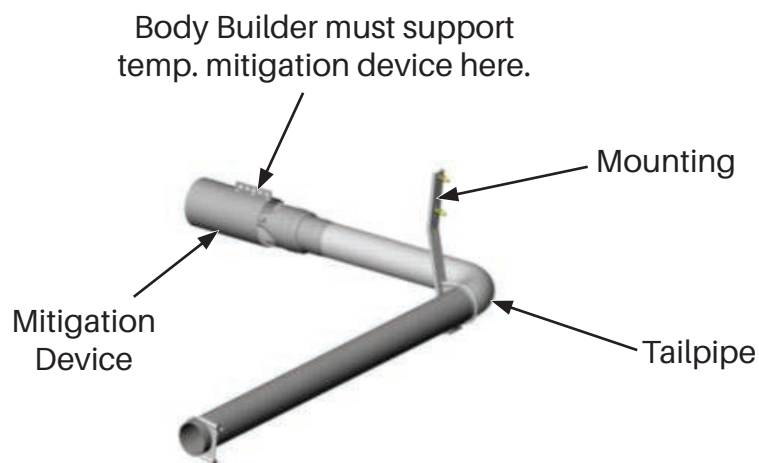

Figure 5-64. Typical Exhaust Tailpipe/Temperature Mitigation

Tailpipe/Temperature Mitigation (If Equipped)

A properly designed and maintained tailpipe/temperature mitigation system removes exhaust gases from the system following the aftertreatment process. [Figure 5-64](#) illustrates a typical tailpipe/temperature mitigation assembly.

The engine manufacturer owner's manual, service, and/or operations, and maintenance documentation **must** be referred to for all tailpipe/temperature mitigation operations, maintenance requirements, and service procedures to be performed. Installation is certified with the engine manufacturer to follow all performance requirements and government regulations. In addition to the engine manufacturer's documentation, the following information is provided for E-One cab and chassis tailpipe/temperature mitigation operation and maintenance.

Tailpipe

The tailpipe is mounted downstream of the aftertreatment system and is connected to the DPF-SCR single module and is usually positioned just forward of the rear tires. Regular inspection and maintenance of the piping is necessary for overall performance of the exhaust and aftertreatment system. Pipes **must** be routinely inspected for cracks, wear points, loose connections, or punctures that can cause leaks. Failure to replace damaged piping may result in loss of engine and aftertreatment performance.

Temperature Mitigation (If Equipped)

The temperature mitigation device reduces exhaust gas temperature at the exit by mixing exhaust gas with ambient air. The temperature mitigation device is sized for the engine and exhaust pipe used. This part is supplied with the chassis and needs to be mounted at the end of the tailpipe and secured to the body by manufacturer.



Modifying the temperature mitigation device or blocking ambient airflow to the device could limit performance, resulting in elevated temperatures at the exit, which may exceed NFPA® guidelines.

Mounting

Brackets secure the tailpipe to the vehicle frame. The tailpipe and mitigation device are assembled using u-clamps or lapping clamps. The mitigation device **must** be secured at location shown in [Figure 5-64](#) by body builder. All clamp torque should be checked regularly to verify proper sealing and check for damage. Regular inspection and maintenance of the clamps and brackets is necessary for overall performance of the exhaust and aftertreatment system. Clamps **must** be routinely inspected to ensure joints between components are tight to prohibit leaks and contamination. Brackets **must** be routinely inspected for loose connections that can cause damage. Failure to replace a damaged mounting component may result in loss of engine and aftertreatment performance and cause exhaust damage.

STEERING SYSTEM

General Inspection And Maintenance

- Ask your service mechanic to examine the steering mechanism. Minor adjustments could head off problems.
- Check tie rod, drag link end clamp bolts, and ball joints. They **must** be kept tight.
- Check for installation and spread of cotter pins and tightness of nuts at both ends of tie rod and drag links.
- Check to see that the pitman arm (steering arm at steering gear) mountings are tight and locked.
- Check system for leaks or hose chafing and if necessary replace at once.
- Check for proper steering gear and power steering pump lubricant levels.
- Regularly inspect steering column joint bolts and steering linkage, particularly for body-to-chassis clearance.

SERVICE PROCEDURES

WARNING

Failure to maintain the steering system in proper condition can cause reduced steering ability resulting in personal injury and property damage. Have any steering problems corrected by a qualified mechanic.

Maintain Steering Column Joint Bolts

As a good maintenance practice, it is recommended that steering column joint bolts be checked for tightness a minimum of every 300 engine hours/6 months, whichever occurs first. Tighten bolts to the torque specified in the table. **DO NOT OVER-TIGHTEN.**

Maintain Hydraulic Power Steering System

Whenever the hydraulic (power steering) system has been opened for any reason, air **MUST** be removed from the system before placing the vehicle in service.

BRAKE SYSTEM

The chassis has an air brake system. To prevent brake bounce, the driver should make brake application by placing heel of foot on the floor, while applying a smooth, even force on the treadle valve pedal (brake pedal) with the ball of foot.

WARNING

Excessive use of the service brakes may cause them to heat up and reduce their stopping ability.

Brake Inspection

Regular inspection is required including the proper draining of any water from air tanks. This will indicate if the air dryer and check valves between tank systems are functioning properly. For further information, refer to Axle Manufacturer's Manual.



Figure 5-65. Brake Inspection

Slack Adjuster Inspection (If Equipped)

Inspect slack stroke to ensure automatic adjuster is working. Stroke indicator on chamber rod (Color or Knurled Band Exposed) indicates slack may need adjusting. Verify by referring to the "free stroke" below.

Check Operation Of The Air Brake System

Weekly (or when air tanks are normally bled off for water content), the air brake system should be checked for proper function. This test assures the check valves are cycled in the system and ensures proper performance of dual air system. When performing pedal applications, depress and hold while listening for air leaks.

A visual inspection of the slack adjuster travel **must** also be made to ensure the slack adjusters are properly adjusted. Refer to the slack adjuster inspection section for further details.

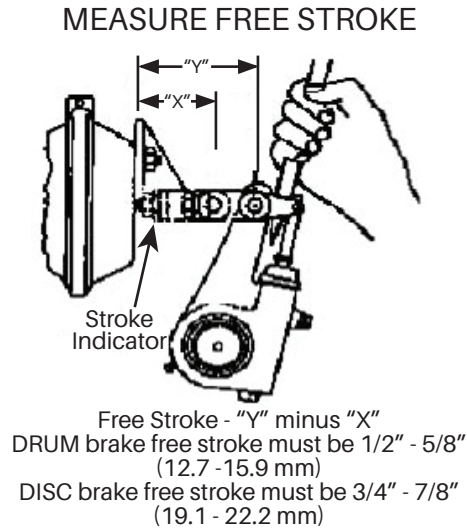

Figure 5-66. Check Brake System

Table 5-2: U.S. DOT Stroke Limits

80-90 psi (550-620Kpa) Pressure in Air Chamber. Clamp Type Air Cleaner	
Chamber Type (Size)	Adjust the stroke as short as possible without the brakes dragging. The vehicle may be put out of service if the stroke is not:
9	less than 1-3/8" (34.9 mm)
12	less than 1-3/8" (34.9 mm)
16	less than 1-3/4" (44.4 mm)
20	less than 1-3/4" (44.4 mm)
24	less than 1-3/4" (44.4 mm)
30	less than 2" (50.8 mm)
36	less than 2-1/4" (57-1 mm)

NOTICE

Vehicle must be parked on level surface, wheel chocks or curbing installed at the front and rear tires, and park brake in the off position.

SERVICE PROCEDURES

STEPS

1. Start engine and build both air systems to full system capacity, approximately 120-130 psi. Shut the engine off.

NOTICE

System #1 should build up to 90 psi before system #2 starts to change.

2. Drain the air from system #2. After the air is drained from system #2, apply the brake pedal. The rear brakes should function. The park brake valve must be in the off position to perform this test.
3. Start the engine and recharge both systems to full capacity approximately 120-130 psi. Shut the engine off.
4. Drain air from system #1. After the air is drained from system #1, apply the brake pedal. The front and rear brakes should both work. The park brake valve **must** be in the off position to perform this test.

If the truck is not equipped with self-adjusting wedge brakes, "P" type "S" cam with automatic slack adjusters, or self-adjusting disc brakes, then visually inspect brake function by observing slack adjuster travel. Travel should not exceed dimension in chart on previous page (refer to the appropriate manufacturer's maintenance manual for proper adjustment).

NOTICE

Park brake system is integral with rear brakes and they MUST be properly adjusted to ensure hold power.

IF THE BRAKES DO NOT FUNCTION AS DESCRIBED ABOVE, CONTACT SPARTAN IMMEDIATELY.

MAINTENANCE FOR TELMA® RETARDERS

Table 5-3: Maintenance for Telma Retarders (If Equipped)

GOAL	FREQUENCY	METHOD	
Washing	Twice a year	Pressurized water, air dry	
Greasing TELMA® (Drive-line mount)	Every 40,000 miles	Fill grease fitting until grease appears at air hole. Avoid grease leakage.	
Mechanical Maintenance	Check at 3,000 miles	Check every 12,500 miles	Check every 40,000 miles
No abnormal play rotor/stator	X	X	X
Tighten bolts & screws	X	X	X
Driveline seals		X	X
Air Gap Measurement	X	X	X
Axle Pinion Seal		X	X
Condition of shock mount (Rubber)			X

GOAL	FREQUENCY	METHOD	
Verify the TELMA® Disengages when Vehicle stops	X	X	X
Electrical Maintenance	Check at 3,000 miles	Check every 12,500 miles	Check every 40,000 miles
Verify Amperage of Retarder			X
Wiring insulation			X
Coil connections			X
Tighten connectors	X	X	X
Ground terminal condition/tightness	X	X	X
Contact box function/condition/tightness	X	X	X
Foot control	X	X	X
Cutoff switch	X	X	X
Indicator lights	X	X	X

AXLES/WHEELS AND TIRES

Weight Information

It is important that drivers and maintenance personnel understand weight-rating terminology as described below. For safety and proper chassis function, it is critical that:

- The axle and tire/wheel weight ratings are not exceeded.
- Proper tire pressures are maintained.
- The major chassis components supporting the vehicle **shall** not to be changed or replaced by components with lower ratings without considering the entire weight of the vehicle (i.e. tires).

IFS-24K Suspension

If unit is equipped with an IFS-24K axle refer to axle manufacturer's manual for detailed information.

Kneeling Feature

Feature allows the vehicle to lower several inches by exhausting air from the air springs. A rocker switch or V-Mux® switch controls actuation. The park brake must be engaged; otherwise, the suspension will automatically air up.

Tires And Wheels

Many tire weight ratings for fire service are based on intermittent use. Intermittent use is defined as; no more than 50 miles of continuous operation under full payload without stopping for a 20 minute cool down.

If it is necessary to travel more than 50 consecutive miles without meeting the cool down requirement, speed **must** be reduced to 50 mph for the balance of the trip.

SERVICE PROCEDURES

It is critical that the proper tire pressure is equivalent side-to-side on the same axle. The maximum tire pressure is stated on the vehicle certification label.

Replacement wheels and tires **must** have equivalent load carrying capacity as the original equipment. Wheels **must** have the same rim width, rim offset, and mounting configuration as the original equipment, while tires **must** be of the same size and type, and conform to government regulations. Wheel nut torque is 450-500 lbs. ft.

NOTICE

Tire balancing on independent front suspensions requires the use of adhesive weights for clearance.

Re-torquing should occur after the initial 50-150 miles are covered in normal driving conditions. This practice ensures that the opportunity for over tightening is minimized. There is little benefit from re-tightening wheel nuts prior to reaching this service threshold, since joint relaxation may be only partial. If audits of initial installation torque are desired, they should be performed as shortly after the initial tightening as possible and should determine the breakaway torque values (the amount of torque required to just begin movement of the nut in the tightening direction).

Check the condition of the tires daily. Look for any bumps, blisters, cuts, punctures, cracks, uneven wear, check for proper inflation, and tread depth. Replace tire on front axle when tread is worn to 4/32 in. (3.175 mm). Replace tire on rear axle when tread is worn to 2/32 in. (1.5888 mm). Always check inflation pressure when tires are cold.

WARNING

Always maintain tires in good condition. Frequently check and maintain correct inflation pressures as specified by the tire manufacturers. Inspect periodically for abnormal wear patterns and replace/repair cut or broken tire casing. Always use experienced properly trained personnel with the correct equipment and procedures to mount or remove tires. Failure to adhere to these warnings could result in tire malfunction, damage to vehicle, personal injury, and possible death.

Rolling Resistance

For model year 2014 and later vehicles, rolling resistance of the tires is critical to greenhouse gas emissions and fuel economy of the vehicle. This vehicle was originally built with tires that are appropriately rated for the weight capacity they may be expected to carry. When replacing tires, it is critical to consider tires with similar tread patterns and the same load capacity as those of which the vehicle was originally equipped. Should you have questions regarding replacement tires, please contact E-One or your nearest tire distributor.

Tire Pressure

Tire pressures **must** be monitored closely to assure safe operation of the vehicle. E-One recommends checking tire pressure daily when the vehicle is in service. It is important to understand that a change in weight distribution or the amount of weight added or removed from the vehicle may require a change to tire pressures. Refer to the Gross Axle Weight section of this manual and the tire manufacturer's manual for details.

Tire Pressure Indicators

If tire pressure indicators were ordered through E-One, the indicators may be obtained by redeeming a voucher through E-One Customer & Product Support. To redeem the voucher, the customer will be required to supply E-One with the Sales Order number or VIN, Vehicle Odometer Reading at time of request, and accurate in-service weights for each axle on the vehicle. This will allow E-One to provide a set of tire pressure indicators that accurately corresponds to the pressure that the tires should be set at for that particular application.

Tire Chains

Your E-One cab and chassis may be equipped with a tire chain system. At the push of either a rocker switch or a virtual switch on the V-MUX® Vista screen, the system provides the driver with chains under the tires to aide with traction in snowy/icy conditions. To engage tire chains the vehicle **must** be traveling between 2 MPH and 25 MPH. Tire Chain will automatically disengage if greater than 30 MPH. Vehicle **must** be reduced to a speed below 5 MPH for the tire chains to be engaged or re-engaged. For additional information on maintenance and operation of the system, please refer to the manufacture's literature.

CAUTION

Due to high spring tension, Disassembly/Assembly of the air cylinder should be done only by qualified personnel.

Installation And Tightening Of Tires And Wheels

Before installing wheels, clean all mounting surfaces with a wire brush. Check to make sure the threads are clean. Refer to the wheel manufacturer's installation and maintenance manual included with this manual for the proper inspection and installation procedures.

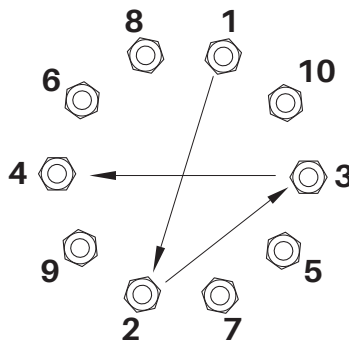

Figure 5-67. Wheel Torque Procedure

- The use of manual torque wrenches **must** be carefully monitored. Dial type torque wrenches are preferred. Click-style wrenches are typically not as accurate as dial-type and can also be affected by hand position. The click-style is also not well suited for determining accurate breakaway torque values. Regardless of type of wrench used, care **must** be exercised so that no more than 500 ft. lbs. are actually applied.
- Re-tightening of wheel nuts should be accomplished "cold" and not with excessively hot brakes. A good rule of thumb for checking this is to retighten only after the wheel disc and nuts are cool enough for continuous skin contact.

SERVICE PROCEDURES

MAINTENANCE SCHEDULES AND CHECKLIST

Maintenance must be performed to keep your vehicle in good operating condition. It is necessary to perform maintenance checks, inspections, lubrication, cleaning, or other types of service. Regular maintenance helps avoid potential problems and may help correct problems before they become serious.

The following maintenance schedule is arranged into mileage and time intervals. The intervals listed are the maximum and must not be exceeded. If your vehicle is operated on very hilly terrain, or in a very dusty or sandy environment, you may need to reduce the time between scheduled maintenance intervals. The maintenance schedule may be copied and used as a check off sheet.

Perform maintenance at whichever interval occurs first. When reaching a particular service level, inspect / perform all previous maintenance items that may be due.

MAINTENANCE SCHEDULE

Recommended Maintenance Practices

- Ensure daily and stated maintenance interval checklist items are performed.

If any information should seem unclear, please contact E-One Customer & Product Support at 1-800-627-5050 Option #1.

Table 5-4: Recommended Maintenance Practices

Service to Perform	Intervals		
	Daily	Annually	Every 300 hours/6 months Whichever Occurs First
Check Engine Oil Level	X		
Check Transmission Fluid Level	X		
Check Engine Coolant Level	X		
Check Power Steering Fluid Level	X		
Check for Fluid Leaks Under Vehicle	X		
Check Tire Condition	X		X
Check Windshield Wiper Function and Wash	X		
Check Park Brake Actuation	X		
Test Air System	X		
Verify Operation of Gauges	X		X
Check Oil Pressure	X		X
Check Horn	X		X
Inspect Mirror Mountings and for Cracks	X		X
Inspect Windshields for Cracks or Chips	X		X
Check Seats for Excessive Wear (Ref 0270-224)			X
Check Seat Belt Actuation (Ref 0270-224)	X		X
Check Steering for Free Play			X
Check Air Compressor Governor			X
Check Air Dryer Operation			X

SERVICE PROCEDURES

Service to Perform	Intervals		
	Daily	Annually	Every 300 hours/6 months Whichever Occurs First
Check Climate Control System			X
Check Engine for Noise Such as Knocks or Misses			X
Check hubs and seals for leaks			X
Inspect Steering Box & Hoses for Leaks			X
Inspect Steering for Loose or Worn Parts	X		X
Inspect Steering Linkage Fasteners			X
Inspect Springs, Hangers, & U-bolts			X
Check U-bolt torque: Front 425 lb.-ft. / Rear per manufacturer's manual			X
Check Engine and Transmission Mounts			X
Check for Leaks: Oil, Fuel, Transmission Fluid, and Coolant			X
Inspect Drive Line: U-joints and Slip Shafts			X
Inspect PTO Drive Line			X
Inspect Brake Chambers: Leaks and Hoses			X
If any information should seem unclear, please contact E-One Customer & Product Support at 1-800-627-5050 Option #1.			
Inspect Brakes, Drums or Rotors			X
Inspect Differential: Leaks and Breather			X
Check Differential Oil Level			X
Check Pump Gear Box Fluid Level			X
Check Transfer Case Fluid Level			X
Inspect Exhaust System for Leaks and Component Secure			X
Check Tire Air Pressure			X
Torque Lugs			X
Check for Bent or Damaged Wheels			X
Check all Lights and Reflectors	X		X
Inspect Cab for Damage	X		X
Remove and Inspect Cab Tilt Cylinder Pins and Cotter Pins for Wear.			X
Check All Cab Doors, Hinges and Latches	X		X
Inspect Cab Latches and Mounts	X		X
Inspect Fuel Tank Mounting, Leaks and Cap			X
Inspect Cross Members for Cracks			X
Check Drive Belts	X		X
Check all Hoses	X		X

SERVICE PROCEDURES

Service to Perform	Intervals		
	Daily	Annually	Every 300 hours/6 months Whichever Occurs First
Test Coolant System for Leaks			X
Inspect Air Conditioning Compressor Mounting			X
Inspect Alternator Mounting and Cables			X
Check Radiator, Heat Exchanger			X
Check Coolant Fan & Shroud for Clearance, Chips, etc.			X
Inspect Air Intake System and Air Filter			X
Inspect Battery Cables (Tight and Corrosion)			X
Verify Starter Operation			X
Check Charging/Load Management System			X
Grease Cab Pivot (if Applicable)			X
Grease all fittings			X
Operate Engine, Verify High Idle and Check for Leaks			X
Service Air Dryers		X	
Service Power Steering System		X	
Perform State Inspections (if Applicable)		X	
Drain Water out of Air Tanks	X		
Inspect and lube Compression Brake (if Applicable)			X
Inspect Engine Air Cooling System for Wear			X
Clean HVAC Drain Lines (Gravity & Venturi)		X	
Air filter element MUST be replaced when the restrictor indicator shows restriction, or annually, whichever occurs first.			
For More Comprehensive Engine Maintenance and Intervals, Go to the Engine Section of Manual and Reference the Maintenance & Operations Sheet and Engine Manual. NOTE: the Maintenance & Operations Sheet takes Precedence over the Manufacturer's Manual			
For More Comprehensive Transmission Maintenance and Intervals, Refer to the Applicable Manual in the Manual Binder			
For More Comprehensive Axle Maintenance and Intervals, Refer to the Applicable Manual in the Manual Binder			
For More Comprehensive Suspension Maintenance and Intervals, Refer to the Applicable Manual in the Manual Binder			
For More Comprehensive SPS Maintenance and Intervals, Refer to the Applicable Manual in the Manual Binder			

Drivers Daily Inspection

Shown below is a sample template /checklist for Driver's Daily Inspection.

Table 5-5: Driver's Daily Inspection

DRIVER'S DAILY INSPECTION FOR APPARATUS NO. _____

	Date	Mileage	Engine Hours	Pump Hours	Engine Oil Level	Engine Oil Leaks	Power Steering Fluid	Coolant Level	Fan Belt Condition	Fan Belt Tension	Coolant Hose Condition	Detrosler functions properly	Heater functions properly	Coolant Leaks	Transmission Oil Level	Transmission Oil Leaks	Volt Meter Reading (Running)	Defrost Fan	Wiper Blade Condition	Mirrors Adjusted	Washer Solvent Level	Brake Air Pressure	Instrument Lamps	Head Lamps	Tail Lamps	Turn Signals	Marker Lamps	Stop Lamps	Warning Lamps	Sack Adjuster Adjustment	Drain Water Out of Air Tanks	Axle Oil Leaks	Wheel Nut Inspection	Tire Inflation	Tire Condition	Water Tank Level	Drain Water From Fuel Filter	By	Shift No.
																																						<div style="text-align: center; font-size: 4em; font-weight: bold; opacity: 0.5;"> FIRE DEPARTMENT </div>	

LEGEND
A = Acceptable
B = Rejected (Log Problem)
C = Corrected
 (Added Oil, Changed Bulb, etc.)

SERVICE PROCEDURES

Electronic Fluids Check

The Electronic Fluid Checks message display is located as a selectable option within the message center on a traditional instrument cluster or the "Messages" area on the Graphic Instrument Cluster. When the master switch is "ON" and the ignition switch is initially turned "ON", fluid levels for the power steering, windshield wiper fluid, engine coolant, and engine oil are being monitored.

The transmission fluid check requires the transmission fluid to reach a certain temperature, reference the transmission manual for more information. The engine oil and power steering fluid levels cannot be accurately read while the engine is running. The display will signal a check fluid message, all levels normal or "NA". If the signal indicates, "check", refer to the applicable manual fluid check procedure for fluid fill level.

Low Oil Level Indicator

Electronic Fluid Level Checks (EFLC), wait 20-30 seconds before starting the engine. If the oil level "pop-up" comes on, the oil level may be low. Verify oil level by checking level with engine dipstick and fill accordingly.

If the engine has been recently running, be sure to allow sufficient time after shutting engine off for oil to drain back into pan. Pre-programmed settings for the switch include a 20 to 30 second delay and **do not** permit functionality when engine is running.

Low Coolant Level Indicator

The instrument panel **shall** feature a low engine coolant indicator light, which **shall** be located in the center of the instrument panel. An audible alarm **shall** also be provided to warn of a low coolant incident. Verify coolant level by checking the sight glass and fill accordingly.

Transmission Oil Level Indicator

The transmission fluid **shall** be monitored electronically through the shift pad, when checking transmission level the fluid temperature **must** be at 140°F minimum. Verify transmission level with transmission dipstick and fill accordingly.

Power Steering Fluid Level Indicator

Electronic Fluid Level Checks (EFLC), wait 20-30 seconds before starting the engine. If the power steering level "pop-up" comes on, the power steering fluid level may be low. Verify power steering fluid level with the power steering dipstick and fill accordingly.

Windshield Fluid Level Indicator

Electronic Fluid Level Checks (EFLC), wait 20-30 seconds before starting the engine. If the windshield washer fluid level "pop-up" comes on, the washer fluid level may be low. When the washer fluid level becomes low, the amber "Check Message Center" indicator light on the instrument panel **shall** illuminate and the telltale icon on the light bar will illuminate. Verify washer fluid level by viewing the container and fill accordingly.

Built- In Diagnostics

The gauges reset to zero and the pointers vibrate briefly when the ignition is first activated the gauges should do a full sweep and the indicators will illuminate briefly indicating that the gauges are operational. If communication between the chassis and gauges is lost, a message pertaining to “No Data” will be displayed and the icons pertaining to those messages will flash. An amber message light will illuminate referring you to the message center screen for message. On the screen a communication error will appear.

Documents Incorporated by Reference







1. ISO 22241-1 NOx Reduction Agent AUS 32. Quality Requirements.
2. SAE J553 Circuit Breakers.
3. SAE J1888 High Current Time Lag Electric Fuses.
4. SAE J2077 Miniature Blade Type Electrical Fuses.
5. NFPA® 1901 National Fire Protection Association.
6. SAE J1939-14 Physical Layer, 500 Kbps.
7. SAE J1939-11 Physical Layer, 250k bit/s, Twisted Shielded Pair.
8. SAE J1939-15 Reduced Physical Layer, 250k bits/s, Un-Shielded Twisted Pair (UTP).
9. ISO 280 footprint, Ultra Micro ISO Automotive relay.
10. **NFPA® 1910** *Standard for the Inspection, Maintenance, Refurbishment, Testing, and Retirement of In-Service Emergency Vehicles and Marine Firefighting Vessels* for completed apparatus maintenance recommendations.







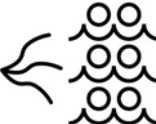

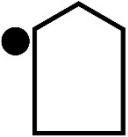
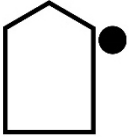
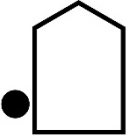
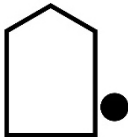

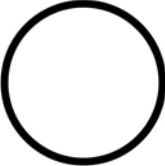





For future use

APPENDIX

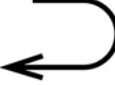
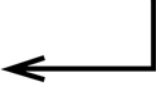

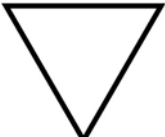



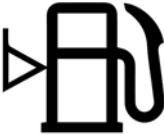



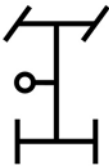











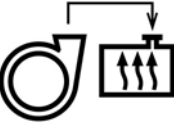

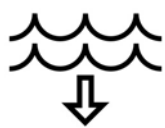











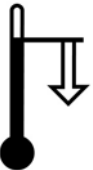



Graphical Symbol Definitions















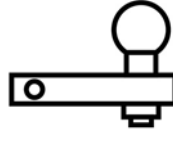





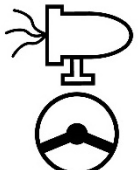
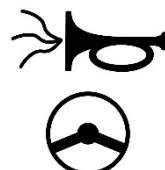

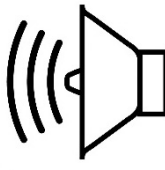

Your apparatus may use graphical symbols to indicate the function of switches, controls, gauges, or components. Study this section so you will understand the meanings of these symbols. For more in-depth explanations of the symbols you can refer to *TC008 Graphical Symbols for Automotive Fire Apparatus* available for download at FAMA.org.

Base Symbols						
						
Water	Foam Concentrate	Foam Solution	Powder	Compressed Air Foam (CAF) Wet	Compressed Air Foam (CAF) Dry	Halotron
						
Location Left Front Cab or Apparatus	Location Right Front Cab or Apparatus	Location Left Rear Cab or Apparatus	Location Right Rear Cab or Apparatus			

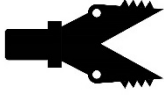
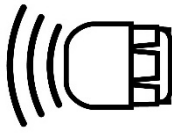



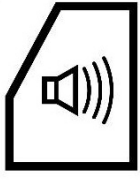

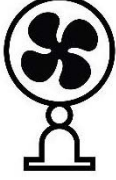
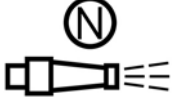
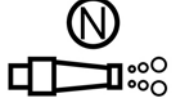
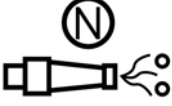
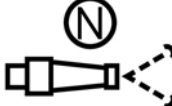
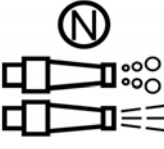
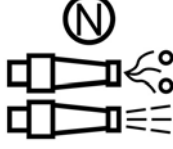
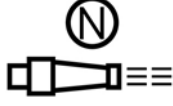



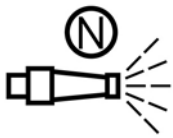
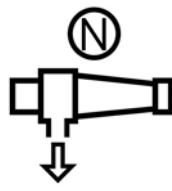
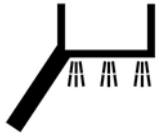

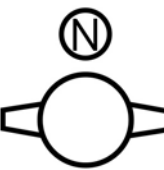
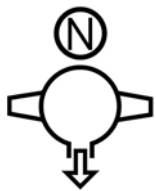
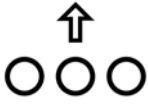



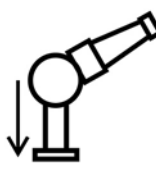

General Symbols						
						
On / Start	Off / Stop	On and Off	Clock / Time Switch / Timer	Fast	Slow	Continuously Variable-Linear
				AUTO symbol for Auto Operation / Automatic Start		
Continuously Variable-Rotational	Unlock or Switch Interlock	Bell or Alarm	Manual Operation / Manual Start	Auto Operation / Automatic Start	Back	Select
						
Up	Down	Warning	Engine Rotational Speed	Engine Rotational Speed-Instantaneous Decrease	Engine Coolant	Fuel Level



APPENDIX

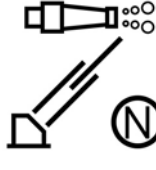
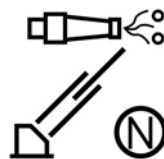
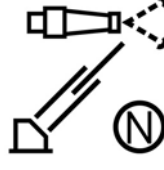
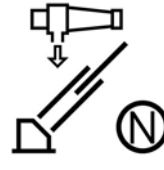

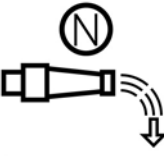
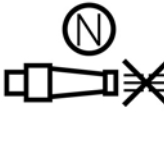

General Symbols						
						
Emergency Stop	Power Take-Off (PTO)	Power Take-Off Engage	Road Mode	Engine Operating Hours	Standby	Breathing Air (SCBA)
						
Siren Mechanical	Horn	Air Horn	Foam Pressure	Hydraulic Pressure	Hydraulic Pump	Air Compressor
						
Radiator Re-Fill	Emergency Power Unit	Water Flush	Air Purge or Drain	Ladder Rack Down	Ladder Rack Up	Compartment Door Alert
						
Pumper Apparatus	Aerial Ladder Apparatus	Suspension Front	Suspension Rear	Helmet Restraint	Compartment Door	Equipment Restraint
						
Auxiliary Cooler	Height of Vehicle Hint for Driver	Width of Vehicle Hint for Driver	GVWR of Vehicle Hint for Driver	Fording Depth Water Crossing Ability	Fording Depth Water Crossing Hint for Driver	Video Camera
						
Rear View Video Camera	Wind Speed	Compartment Door Open	Apparatus Front View	Aerial Apparatus Front View	Exterior Rear View Mirror 4-Way Adjustment	Exterior Rear View Mirror 2-Way Adjustment

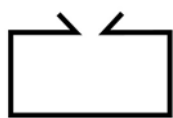
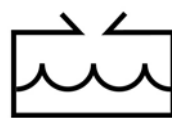
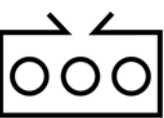

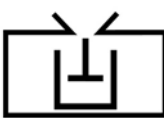
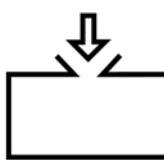
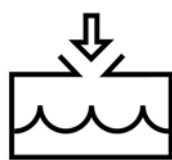

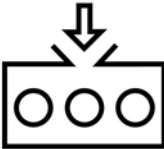
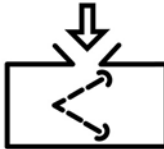
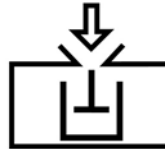
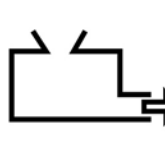
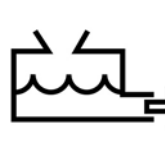
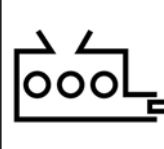
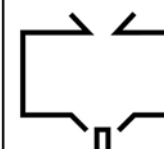
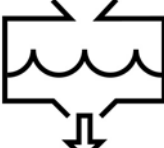
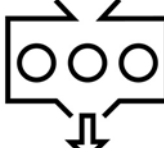
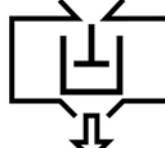
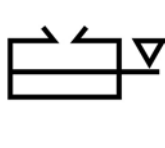
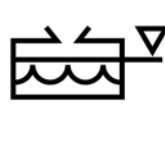
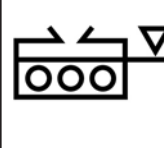
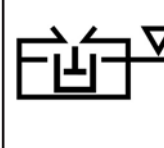

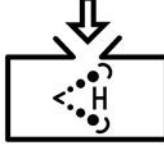









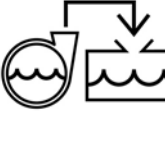
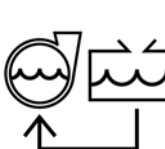

General Symbols						
						
Exterior Rear View Mirror Heat	Engine Cooling Fan Clutch Lock	Traffic Signal Preemption OFF	Engine Emergency Shut-Down	Ball Hitch or Ball Hitch Receiver	Tanker or Tender	Brush Truck or Mini-Pumper
						
Wildland Apparatus	Digital Alert Warning System	Siren Brake	Automatic Tire Chain	Siren Operated by Steering Wheel Center Switch	Air Horn Operated by Steering Wheel Center Switch	Generator PTO Engage
						
Air Compressor PTO Engage	Transmission Retarder or Brake	Engine Compression or Exhaust Brake	Neutral	Cab Heat	Electronic Siren	Electronic Siren Activated through Steering Wheel Horn Button
						
Front Axle Brake Lock	Extrication Tools	Low Frequency Electronic Siren (Rumbler)	AM/FM Radio, Stereo, etc.	Engine Emergency Stop Reset	Buzzer Sounding in Cab	Buzzer Sounding in Tiller Cab
						
Buzzer Sounding at Body	Defog Fan					
Discharge & Intake						
						
Water Discharge	Foam Discharge	CAF Discharge	Powder Discharge	Foam or Water Discharge	CAFS or Water Discharge	Stream

APPENDIX





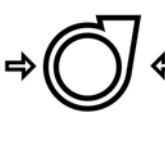

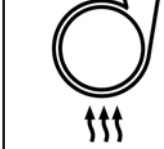
Discharge & Intake						
 Fog	 Discharge Drain or Bleeder	 Aerial Platform Water Curtain	 Pavement Cooler Discharge	 Intake	 Intake Drain or Bleeder	 Foam Intake
 Remote Monitor	 Manual Monitor	 Monitor Elevate	 Monitor Depress	 Monitor Lower	 Monitor Raise	 Monitor Rotate CCW
 Monitor Rotate CW	 Monitor Oscillate	 Monitor Stow	 Monitor Drain or Bleed	 Aerial Water Discharge	 Aerial Foam Discharge	 Aerial CAF Discharge
 Aerial Powder Discharge	 Aerial Discharge Drain	 Aerial Intake	 Shower Discharge	 Nozzle Flush	 Nozzle Off	 Water Flow Rate
 Water Flow Total						





Tank						
 Tank	 Water Tank	 Foam Tank	 Powder Tank	 Hydraulic Tank	 Tank Fill	 Water Tank Fill

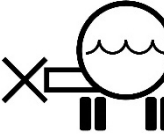
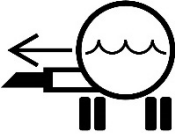
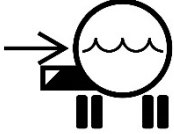
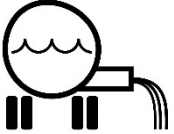
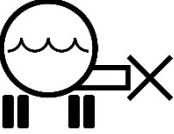
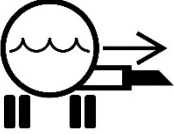
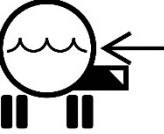
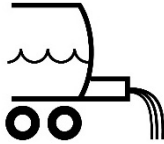
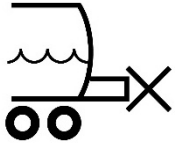
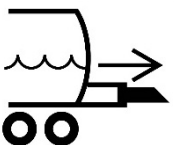
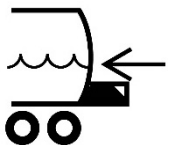



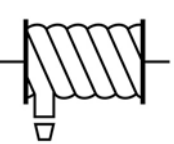
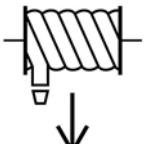
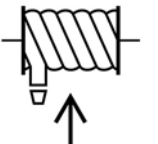

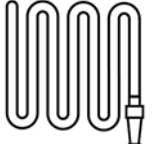
Tank						
						
Foam Tank Fill	Powder Tank Fill	Hydraulic Tank Fill	Tank Outlet	Water Tank Outlet	Foam Tank Outlet	Tank Drain
						
Water Tank Drain	Foam Tank Drain	Hydraulic Tank Drain	Tank Level	Water Tank Level	Foam Tank Level	Hydraulic Tank Level
						
Water Tank Heater	Halotron Tank Fill	Powder Tank Drain				

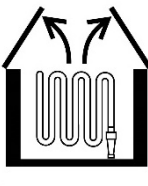
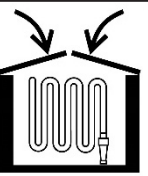
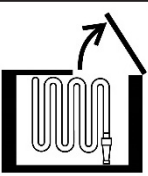
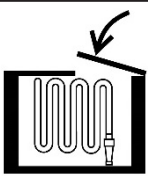
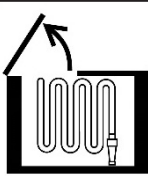
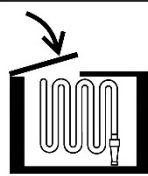







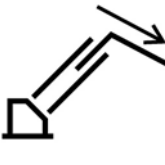



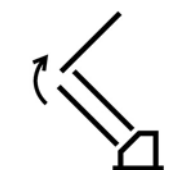
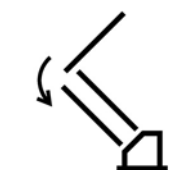
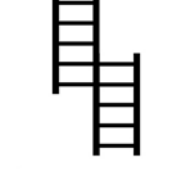

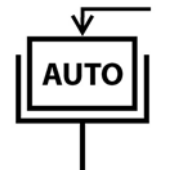
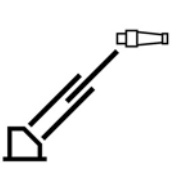
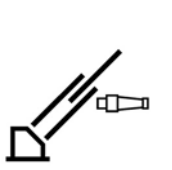

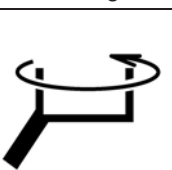
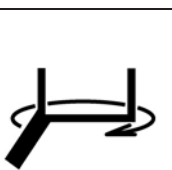
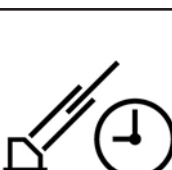

Fire Suppression Pump Functions & Features						
						
Pump	Pump Engage	Pump Engage Manually	Water Pump Engage	Foam Pump Engage	Pump Intake	Pump Discharge
						
Pump Priming	Pump Priming	Pump Drain	Pump-to-Tank Valve	Tank-to-Pump Valve	Pump Cooling Recirculation Valve	Pump Water Temperature
						
Pump Transmission Temperature	Water Pump Discharge Relief	Foam Pump Discharge Relief	Pump Low Pressure	Pump High Pressure	Pump Ultra High Pressure	Pump Heater



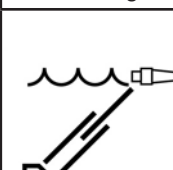
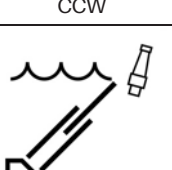



APPENDIX

Fire Suppression Pump Functions & Features						
 Pump Compartment Heater	 Pump Hour	 Pump Pressure Governor	 OK to Pump	 Dump Chute Left OPEN	 Dump Chute Left CLOSE	 Dump Chute Left EXTEND
 Dump Chute Left RETRACT	 Dump Chute Right OPEN	 Dump Chute Right CLOSE	 Dump Chute Right EXTEND	 Dump Chute Right RETRACT	 Dump Chute Rear OPEN	 Dump Chute Rear CLOSE
 Dump Chute Rear EXTEND	 Dump Chute Rear RETRACT	 Foam Pump	 Foam Pump OFF			

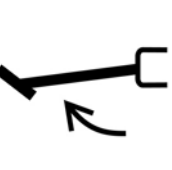

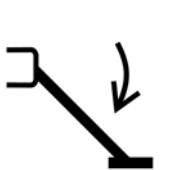

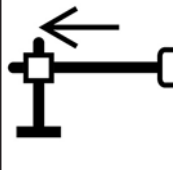
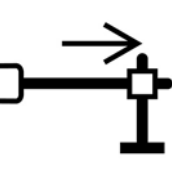
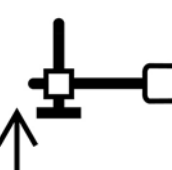
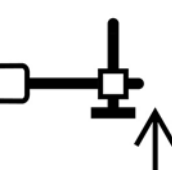
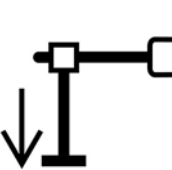
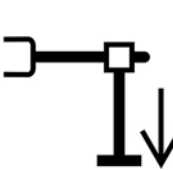





Hose						
 Hose Reel	 Hose Reel Wind Out	 Hose Reel Wind In	 Pre-connected Hose	 Hose	 Hose Restraint	 Hose Bed Cover OPEN
 Hose Bed Cover CLOSE	 Hose Bed Cover RH OPEN	 Hose Bed Cover RH CLOSE	 Hose Bed Cover LH OPEN	 Hose Bed Cover LH CLOSE		

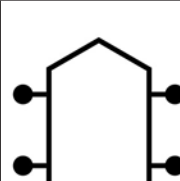
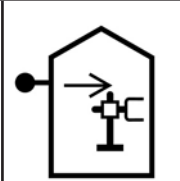
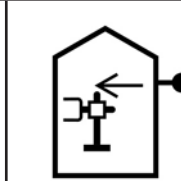
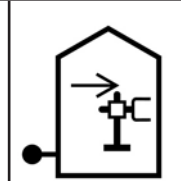

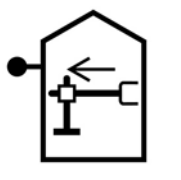
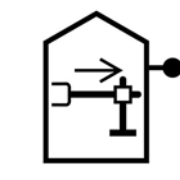
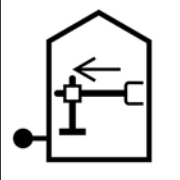
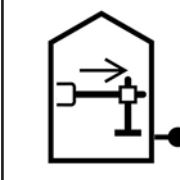
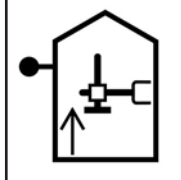
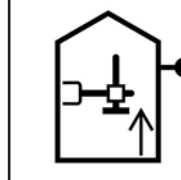
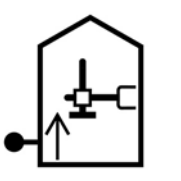
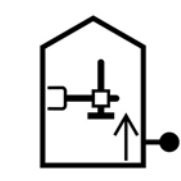
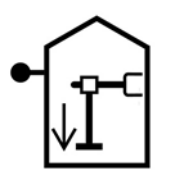
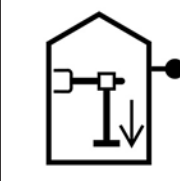
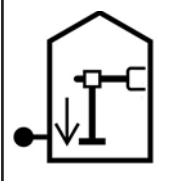
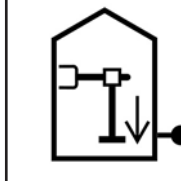
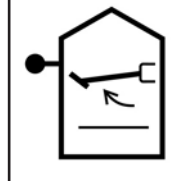

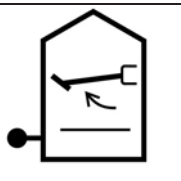
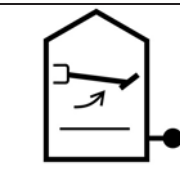
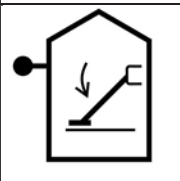
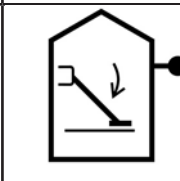
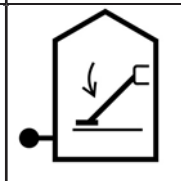
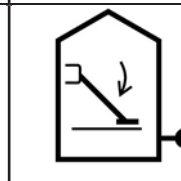
Aerial Device						
 Aerial Extend	 Aerial Retract	 Aerial Elevate	 Aerial Depress	 Aerial Rotate CCW	 Aerial Rotate CW	 Aerial Articulate Extend



Aerial Device						
						
Aerial Articulate Retract	Aerial Articulate Elevate	Aerial Articulate Depress	Aerial Boom Raise	Aerial Boom Lower	Ladder Rungs Aligned	Aligned with Cradle
						
Automatic Aerial Stowing	Aerial Monitor Water Tower Mode	Aerial Monitor Rescue Mode	Movable Monitor Not Secure	Aerial Overload	Aerial Platform Overload	Aerial Platform Leveling
						
Aerial Platform Rotate CCW	Aerial Platform Rotate CW	Aerial Hours	Aerial Power	Aerial Device Enable	Tip Controls Enable	Aerial Waterway Wet
						
Aerial Nozzle Angle Up	Aerial Body Collision Alert	Aerial Body Collision OFF	Aerial Device Not Stowed	Stabilizer Not Stowed	Trailer Jackknife Warning	Ladder Ramp Adjust

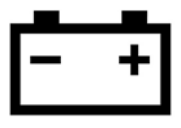



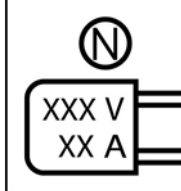
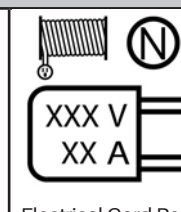

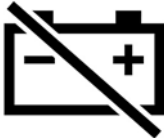

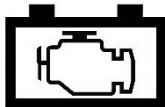















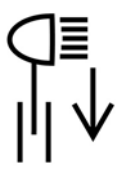



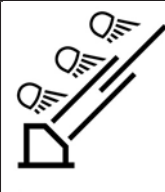

Stabilizers						
						
Left Stabilizer Up	Right Stabilizer Up	Left Stabilizer Down	Right Stabilizer Down	Left Beam In	Right Beam In	Left Beam Out
						
Right Beam Out	Left Jack Up	Right Jack Up	Left Jack Down	Right Jack Down	Stabilizer Off-Level Warning	Stabilizers Automatic Leveling

APPENDIX

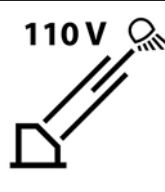
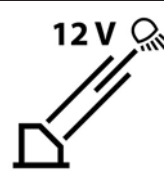

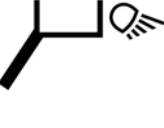











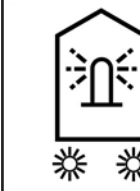



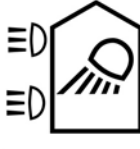
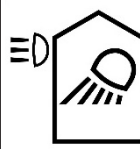
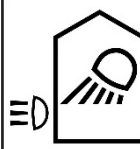





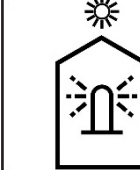
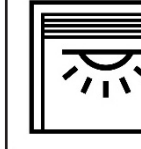
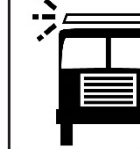



Stabilizers						
						
Stabilizers Manual Leveling	Stabilizers Short-Jack Warning	Stabilizers Set	Stabilizers Locations	Front Left Beam In	Front Right Beam In	Rear Left Beam In
						
Right Rear Beam In	Front Left Beam Out	Front Right Beam Out	Rear Left Beam Out	Rear Right Beam Out	Front Left Jack Up	Front Right Jack Up
						
Rear Left Jack Up	Rear Right Jack Up	Front Left Jack Down	Front Right Jack Down	Rear Left Jack Down	Rear Right Jack Down	Front Left Stabilizer Up
						
Front Right Stabilizer Up	Rear Left Stabilizer Up	Rear Right Stabilizer Up	Front Left Stabilizer Down	Front Right Stabilizer Down	Rear Left Stabilizer Down	Rear Right Stabilizer Down
						
Left Stabilizer Extend Inclined	Right Stabilizer Extend Inclined	Left Stabilizer Retract Inclined	Right Stabilizer Retract Inclined			







Electrical						
						
Battery	Ammeter	Generator	Generator Pre-Heater	Voltmeter	Electrical Outlet	Electrical Cord Reel Outlet



Electrical						
						
Battery Disconnect	Intercom	EV Battery Management System (BMS) Battery Indicator	Engine Starter Battery Indicator			

Lighting						
						
Panel Light	Dome Light	Flood Light	Adjustable Work Light	Reading Light	Engine Compartment Light	Pump Compartment Light
						
Hose Bed Light	Front Scene Light	Rear Scene Light	Left Side Scene Light	Right Side Scene Light	Perimeter Ground Lights	Elevating Light
						
Elevating Light Raise	Elevating Light Lower	Elevating Light Elevate	Elevating Light Depress	Elevating Light Rotate CCW	Elevating Light Rotate CW	Elevating Light Stow
						
Aerial Base Light	Aerial Tip Light	Aerial Ladder Climbing Light	Day Night Switch	Low Level Interior Illumination	Aerial Tip Light Line Voltage	Aerial Tip Light Low Voltage
						
Blocking Mode Night	Platform Bucket Bottom Lights	Platform Bucket Front Lights	Platform Bucket Side Lights	Emergency Master Lighting	Elevating Light Behind Cab Left Side	Elevating Light Behind Cab Right Side

APPENDIX

Lighting						
 Elevating Light Rear Body Left Side	 Elevating Light Rear Body Right Side	 Warning Light-Front	 Warning Light-Side	 Warning Light-Rear	 Scene Light-Front	 Scene Light-Rear
 Alley Light Left Side	 Alley Light Right Side	 Scene Light Left Side	 Scene Light Left Front	 Scene Light Left Rear	 Scene Light Right Side	 Scene Light Right Front
 Scene Light Left Rear	 Headlamp Wig-Wag	 Warning Light Mechanical Spinning	 White Warning Lights OFF	 Warning Light Single Front	 Compartment Light	 Light Bar
 Brow Light Narrow Beam	 Brow Light Wide Beam	 Headlights Flashing	 Docking Lights	 Command Light Green	 White Warning Lights	 Brow Light Spot Beam
 Rear Cab Scene	 Scene Light - PS Rear	 Scene Light - DS Rear	 Traffic Advisor Stick Split	 Traffic Advisor Left	 Traffic Advisor Right	 Scene Light Master

Foam & CAFS						
 Foam Concentrate Injection	 Foam Concentrate Injection Rating by Percent	 Foam Concentrate Injection ON	 Foam Concentrate Injection OFF	 Foam Concentrate Injection ON-OFF	 Foam Concentrate and Air Injection	 Foam Concentrate and Air Injection ON

Foam & CAFS						
 <p>Foam Concentrate and Air Injection OFF</p>	 <p>Foam Concentrate and Air Injection ON-OFF</p>					

For future use



REVGROUP

CAT. E-ONE-AFT-2401